

# the Nansen LEGACY



## Sampling Protocols

Version 3



# Sampling Protocols

Version 3

October 26, 2018

**To be cited as:** The Nansen Legacy (2020). Sampling Protocols Version 3. *The Nansen Legacy Report Series* 11/2020. DOI: <https://doi.org/10.7557/nlrs.5717>

© The authors. This report is licensed under the [Creative Commons Attribution 4.0 International](https://creativecommons.org/licenses/by/4.0/) license

ISSN 2703-7525

Publisher: Septentrio Academic Publishing, Tromsø, Norway

# 1 Table of contents

2	Motivation .....	7
3	Labelling of samples and data from cruises within the Nansen Legacy project .....	7
4	Transects, process stations, and mooring sites.....	10
5	Bridge-based observations .....	15
5.1	Ice observations .....	15
6	Underway sensors/measurements.....	15
6.1	Surface water partial pressure of CO <sub>2</sub> (pCO <sub>2</sub> ).....	15
6.2	Surface water dissolved oxygen.....	16
7	Water column structure.....	16
7.1	CTD .....	16
7.2	ADCP.....	21
8	Water samples from Niskin bottles.....	22
8.1	Salinity samples.....	23
8.2	Sampling of DIC, AT and pH.....	23
8.2.1	Total dissolved inorganic carbon (DIC) .....	23
8.2.2	Total alkalinity (AT) .....	24
8.2.3	pH .....	25
8.3	Sampling for $\delta^{18}\text{O}$ (delta-O-18).....	26
8.4	Total Organic Carbon (TOC).....	28
8.5	Particulate Organic Carbon (POC) and Nitrogen (PON) .....	30
8.6	Trace metal (TM) and dissolved organic matter characterization (DOM) sampling 32	
8.6.1	DOC-characterization.....	35
8.7	Sampling for CDOM.....	38
8.7.1	Measurement of CDOM absorbance .....	41
8.8	Particulate element concentration using xrf.....	45
8.9	Inorganic nutrients .....	49
8.10	Water column sampling for algal pigment concentrations (chlorophyll <i>a</i> , phaeopigments)	

.....	51
8.10.1 Measurements of algal pigment concentrations (chl a, phaeopigments) based on samples from water column and sea ice .....	53
8.11 Concentrating protists <10 µm by VivaFlow filtration .....	57
8.12 Light microscopy phytoplankton/protists.....	59
8.13 Light microscopy large protists/rare taxa.....	60
8.14 Metabarcoding (DNA and RNA) of protists and prokaryotes .....	63
8.15 Metatranscriptomics (mRNA) of protists and prokaryotes.....	67
8.16 Flow cytometry sampling .....	71
8.17 Bacterial biomass production .....	72
8.18 Iron Chloride Precipitation of viruses from seawater .....	74
8.19 Viral production and decay (Rev.1).....	77
8.20 Coccolithophores and other small plankton for SEM .....	79
8.21 Microalgal diversity by culturing (serial dilutions) .....	81
8.22 Determination of <i>in situ</i> Primary Productivity Rate \ using the 14C method.....	83
8.23 Determination of Primary Productivity Rate in Relation to Light Intensity (P vs I curves) using the <sup>14</sup> C method .....	89
9 Water samples from GoFlo bottles .....	95
9.1 Trace elements.....	95
10 Short-time drifting sediment traps .....	97
11 Net sampling.....	99
11.1 Phytoplankton net haul sampling.....	99
11.2 Microalgal diversity by culturing (capillary isolation).....	101
11.3 Protist diversity by single cell PCR .....	104
11.4 Zooplankton sampling .....	106
11.4.1 Microzooplankton abundance & biomass .....	106
11.4.2 Mesozooplankton.....	107
11.4.3 Macrozooplankton abundance, biomass & genetics .....	110
11.4.4 Zooplankton acoustics EK80 .....	113
11.4.5 Macrozooplankton for ecotox, stable isotopes & lipid samples.....	116
11.5 Manuals zooplankton nets .....	116
11.5.1 Multinet manual .....	116

11.5.2	Macroplankton trawl.....	119
11.5.3	Macrozooplankton ring net.....	121
11.5.4	WP2/WP3 net .....	121
11.6	Pteropod sampling with WP2.....	121
11.7	Planktonic foraminifera sampling with mulitnet .....	126
12	Benthic sampling.....	127
12.1	AeN team members interested in benthic invertebrate samples and seabed sediment samples .....	127
12.2	Sampling gear.....	128
12.3	Gear specs and deployment in brief .....	129
12.3.1	Galvanize steel beam trawl (Figure 1a,b).....	130
12.3.2	Box corer (Figure 1e).....	131
12.3.3	Campelen 1800 with Rockhopper ground-gear trawl (1c,d) .....	131
12.3.4	Gemini corer (Figure 1f).....	132
12.3.5	van Veen Grab (back up to Box corer) (Figure 1 e).....	132
12.4	Sampling .....	134
12.4.1	Beam trawl and Campelen trawl .....	134
12.4.2	Box corer .....	136
12.4.3	Gemini corer: Meiofauna.....	139
12.5	Sample labelling.....	142
12.6	Sample Processing.....	142
12.6.1	Quantitative community samples .....	142
12.6.2	Food web .....	144
12.6.3	Contaminants .....	144
12.6.4	Sediment properties .....	145
12.7	Types of data to be generated – parameter definitions .....	146
12.7.1	Quantitative community samples .....	146
12.7.2	Process / rate measurements.....	146
12.7.3	Food web .....	147
12.7.4	Sediment properties .....	147
12.8	Sediment Extraction for trace elements .....	147
12.9	Dark DIC uptake in sediments.....	148

13	Fish .....	150
13.1	Før tokt .....	150
13.1.1	Tester og programvare o.l.....	150
13.1.2	Oppsett av prøvetaking og FishMeter.....	150
13.1.3	Serienummer og toktnummer til fartøyet.....	150
13.1.4	Stasjonsdata_trål koding .....	150
13.1.5	Anbefalt ekstrautsyr til bruk under 0-gruppeundersøkelser .....	150
13.2	Under tokt.....	151
13.2.1	Merking av prøver .....	151
13.2.2	Datahåndtering.....	151
13.3	Prøvetaking til ulike behov og stasjons typer .....	152
13.3.1	Prøvebehandling og sortering på dekk.....	153
13.3.2	Prøvebehandling og sortering i lab .....	153
13.3.3	Lengdeprøvetaking .....	154
13.3.4	Målarter og andre arter .....	154
13.3.5	Maneter, pelagiske amfipoder og krill .....	156
13.3.6	Koding av 0-gruppeprøver .....	157
13.3.7	Boss/Søppel .....	158
13.3.8	Overføring fra målebrett til Sea2Data .....	159
13.4	Etter tokt .....	161
13.4.1	Avlevering av data .....	161
13.5	Nyttige adresser .....	161
13.6	sampling for polar cod, atlantic cod and capelin by denersal and pelagic trawl 161	
13.7	Biological samples from Polar cod, Atlantic cod and Capelin – baseline study & genomic study ..... .....163	
14	Marine mammals .....	168
15	Ecotoxicological samples.....	169
15.1	Aims and method.....	170
15.1.1	Water sampling.....	170
15.1.2	Zooplankton sampling.....	171

15.1.3	Benthic sampling.....	171
16	Ice work.....	175
16.1	Safety brief.....	175
16.2	Selection of the ice floe .....	176
16.3	Ice working teams.....	177
16.4	Sampling of ice cores.....	178
16.5	Cutting of ice core .....	179
16.5.1	Physics cores.....	179
16.5.2	Nutrient chemistry cores.....	180
16.5.3	Chemistry cores.....	180
16.5.4	Backup core.....	183
16.5.5	Primary/bacterial productivity cores.....	183
16.5.6	Primary production P vs I curve core.....	183
16.5.7	Meiofauna and protist cores.....	184
16.5.8	Stable isotope cores.....	184
16.5.9	Genomic cores .....	185
16.6	Deployment of in situ incubations/Sediment traps.....	185
16.7	On-ice CTD .....	185
16.8	On-ice water sampler .....	185
16.9	Melt pond samples .....	186
16.10	Snow sampling .....	186
17	Geological sampling.....	187
17.1	Sediment sampling.....	188
17.1.1	Short sediment cores (2 ka) – Multicorer .....	188
17.1.2	Long sediment cores (14ka) – gravity/calypso corer .....	200
17.2	Water sampling .....	201
17.2.1	Geology proxy development of stable isotope analysis.....	201
18	Methods guest researchers and previous cruises .....	205
18.1	TOC, TN, TS, C/N ratios, Fe speciation .....	205
18.1.1	CTD sampling for nutrients and ICP analysis.....	205
18.1.2	Multicore sampling.....	206
18.1.3	Gravity core sampling .....	209

## 2 Motivation

The collection of detailed sampling protocols is crucial tool for the success of the *Nansen Legacy*, because they ensure:

- Methodological agreement between the involved researchers
- Continuity and comparable data throughout the 5 years sampling period
- An easily accessible overview over parameters sampled
- Easier cruise planning

## 3 Labelling of samples and data from cruises within the Nansen Legacy project

**Method responsible:** Pål Ellingsen (UNIS, data.nleg@unis.no), TBA

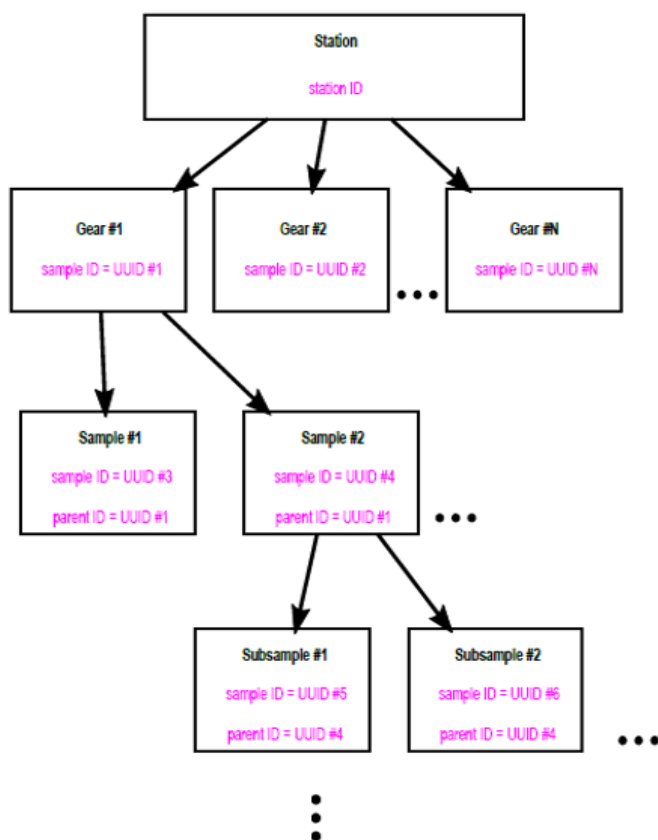
To secure a FAIR (Findable, Accessible, Interoperable, Reusable) data management within the project, a first step is to ensure that the collected samples are findable, and that relevant metadata are logged along with the sample collection. The metadata need to be logged in a standardized manner and will be made accessible through a search interphase as soon as possible after the cruises.

To help cruise and project participants keep track of their samples, a system where each sample is given a unique ID (**a UUID; Universally Unique ID**) has been developed. The UUID will follow each sample and is printed as a Data Matrix code on sticker labels which are placed on the sampling containers. The value of the Data Matrix (see Fig. 2-1) is read by hand-held scanners or cellphones and automatically written into an excel sheet along with sample metadata. This allows for easy tracking of the samples using the Data Matrix.

Sampling within the project is to a large degree hierarchical, where we use a sampling gear (for instance a MIK net) which is subsampled to measure different parameters (community composition, sample biomass, single species collection etc.). It is essential to be able to trace the individuals back to the sampling gear, station and cruise, and the UUID system used facilitates this through a hierarchical parent/child ID. The sampling gear is given a UUID which is used to trace all subsamples taken from that one gear deployment. A subsample taken from the gear is given another UUID, but at the same time it is referred back to the parent UUID. Any sample taken from the subsample is given another UUID, and refers back to its parent (that is, the subsample UUID) as described in Fig. 2-1. Thus, we



only need to keep track of two hierarchical levels of UUIDs for every sample but will be able to trace all samples back to sampling gear and the relevant metadata (station ID, cruise ID etc.) through the family tree.



*Fig. 1 The hierarchical system with sample/subsample IDs used to trace samples and data within the project.*

UUID, version 1 is saved as a Data Matrix:



Value: f78d2bfa-8053-11e8-b4dd-a0481c9e7d26

## Standardized metadata

The metadata (and later on the data) needs to be logged according to accepted standards using a controlled vocabulary to allow for compatibility with the databases where our metadata and data will be made findable and accessible. We will use the Darwin Core standard wherever it is available for the biological/chemical/palaeontological data, and the NetCDF/CF standard for physical data. To build up an excel sheet where the standardized formats are used for the required metadata information, an excel template generator has been made available through the **SIOS webpage**:

<https://sios-svalbard.org/cgi-bin/darwinsheet/index.cgi>

During the 2018 cruises with “Kronprins Haakon” it will also be available on the ships internal network:

<http://10.3.65.20/cgi-bin/darwinsheet/index.cgi>

The required fields needed to log for every sample and subsample collected within the project is already selected in the excel template generator, and extra fields that may be relevant for different samples and where a controlled vocabulary already exists can be added (which is recommended to do). The required fields include a minimum of metadata information necessary, and most of this information can be taken directly from the screens/cruise logger onboard KPH. The excel sheet is set up to control the content of the cells, and thus it is not possible to write information in a wrong format (e.g. the date has to be written as YYYY-MM-DD). The generated excel sheet can be added additional fields which individual researchers want to log for their own samples. All the parameter definitions are explained in the excel template generator (when the mouse is held over the term), and there is also an explanation for the different parameters in the individual cells of the generated excel sheets.

### The UUID generator

In some cases, it is necessary to generate a UUID for a sample or a subsample which is not kept. This could for example be the sampling gear UUID in cases where all samples collected from the sampling gear represent unique subsamples and are labelled with their subsample ID. In such cases, UUIDs can be generated through the UUID generator:

KPH internal network: <http://10.3.65.20/cgi-bin/darwinsheet/uuid.cgi>  
SIOS portal: <https://sios-svalbard.org/cgi-bin/darwinsheet/uuid.cgi>.

The UUID is copied into the excel sheet, but there is no labelled sample with the UUID.

### Printing of sample labels

Sample labels can be printed in different sizes and label qualities depending on sample type. All labels must include the UUID which is printed as a Data Matrix using label printers. The label printers can be accessed here:

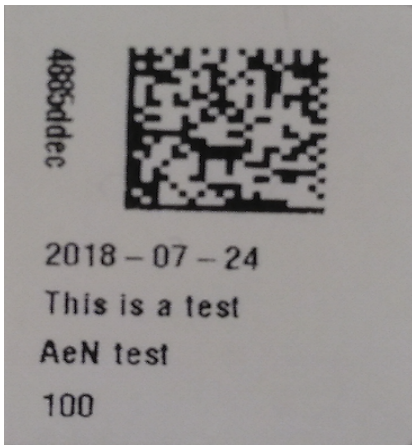
<http://10.3.65.20/cgi-bin/darwinsheet/print.cgi> (via the KPH internal network).

We recommend that sampling containers are also labelled according to individual researchers' standard procedures, so that it is possible to identify them also without scanning the Data Matrix.

- **Small labels** – the smallest sized labels include only the Data Matrix on small stickers that can be added to e.g. Eppendorf lids. These labels must be put

on a flat surface to allow the Data Matrix to be scanned. These are most relevant to use with pre-labelled small tubes, in particular in cases where many samples are collected from the same sampling gear/subsample.

- **Medium-size labels** – these labels include the possibility of adding four lines of written information to ease the identification of the samples without scanning the Data Matrix.
- **Large labels** – these labels are used for labelling of larger samples.



**Fig. 2 (left)** Medium-sized labels with the possibility of adding sample information in addition to the Data Matrix.

**Fig. 3 (right)** Setup showing one of the label printers, a scanner, and the small and medium-sized labels with printed Data Matrix codes.



## 4 Transects, process stations, and mooring sites

The Nansen LEGACY transect and stations are defined below. It consists of 25 stations (of which 7 are defined as process study stations) covering the northern Barents Sea from south of the Polar Front to the Arctic Ocean (Fig. 3.1-1). Which, and how many of the stations that will be conducted on each Nansen LEGACY survey will vary among the surveys depending on ship time, sea ice conditions and focus of the survey.

Location of the process study stations are motivated by 1) they should cover both Arctic and Atlantic conditions for comparison, 2) some of them should have sediment conditions suitable for geological coring, and 3) some of them should have moorings to get data throughout the year (for seasonality).

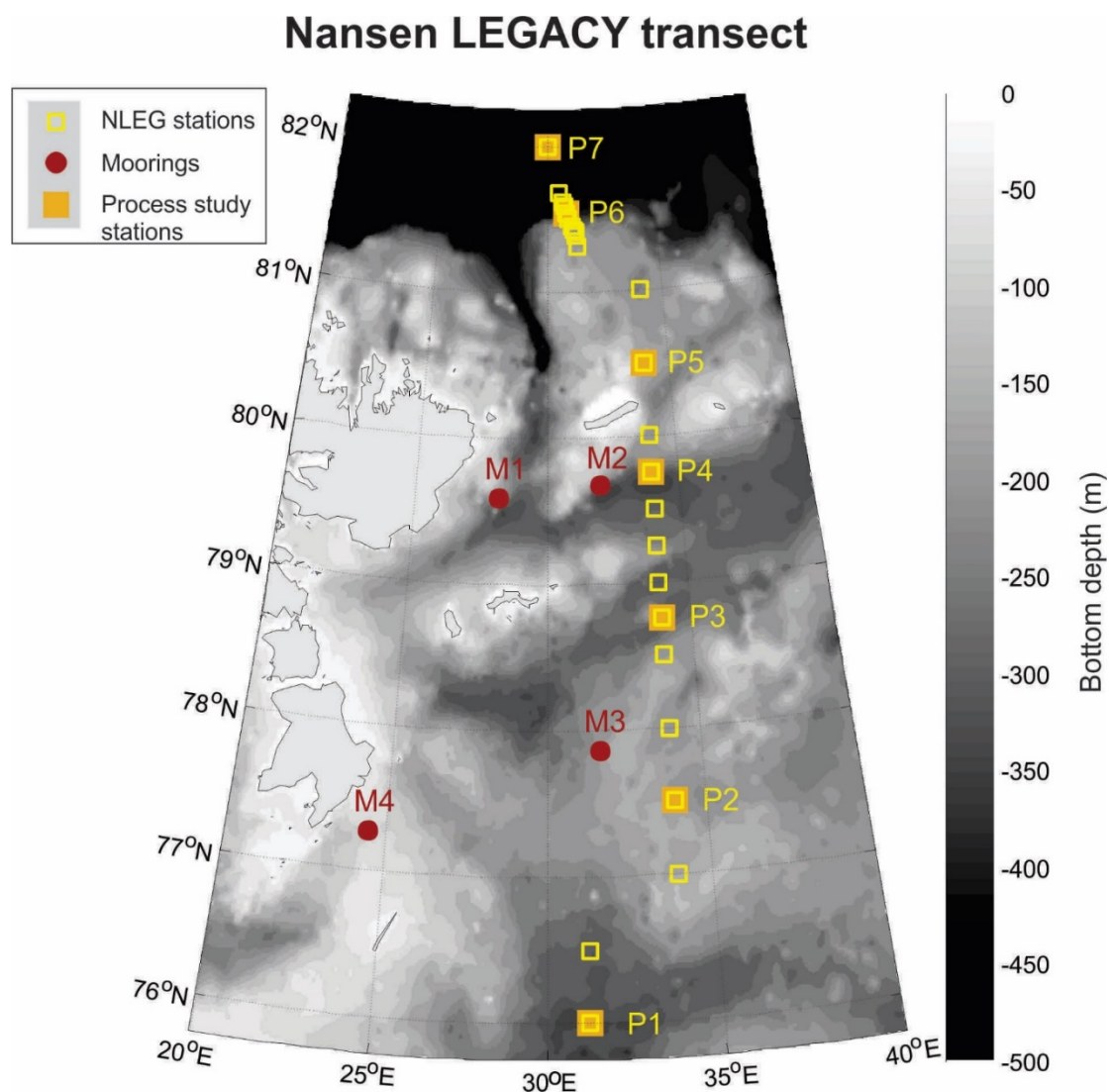
Location of the main RF1 moorings (M1-M4) are motivated by the need of measuring the flow of Atlantic Water into the northern Barents Sea. These moorings will be deployed in 2018 and will be extensively equipped with instrumentation measuring the properties of the inflowing Atlantic Water as well as the rest of the water column. The process study stations to study the Arctic species must be placed at locations dominated by Arctic conditions. Moorings will

be deployed at some of the locations in 2019 to obtain year-round time series at the Arctic process study sites.

### Brief description of the process study stations (see also Figure 2):

**P1** – located in Atlantic Water south of the Polar Front. P1 is suitable for comparing the Atlantic Water dominated, southern Barents Sea with the Arctic Water, dominated northern Barents Sea. P1 is likely to be free of sea ice during most of the winter. Being in a deeper trench, P1 is expected to have suitable sediments for geological coring.

**P2** – located at the central/northern part of Storbanken in a region which usually have Arctic conditions in the intermediate part of the water column. P2 is likely to have varying sea ice coverage during winter, and a moderate surface layer of meltwater during summer.



*Fig. 1. Map of the Nansen LEGACY process study stations (P1-7) and transect (yellow squares) and mooring locations (red dots, M1-4).*

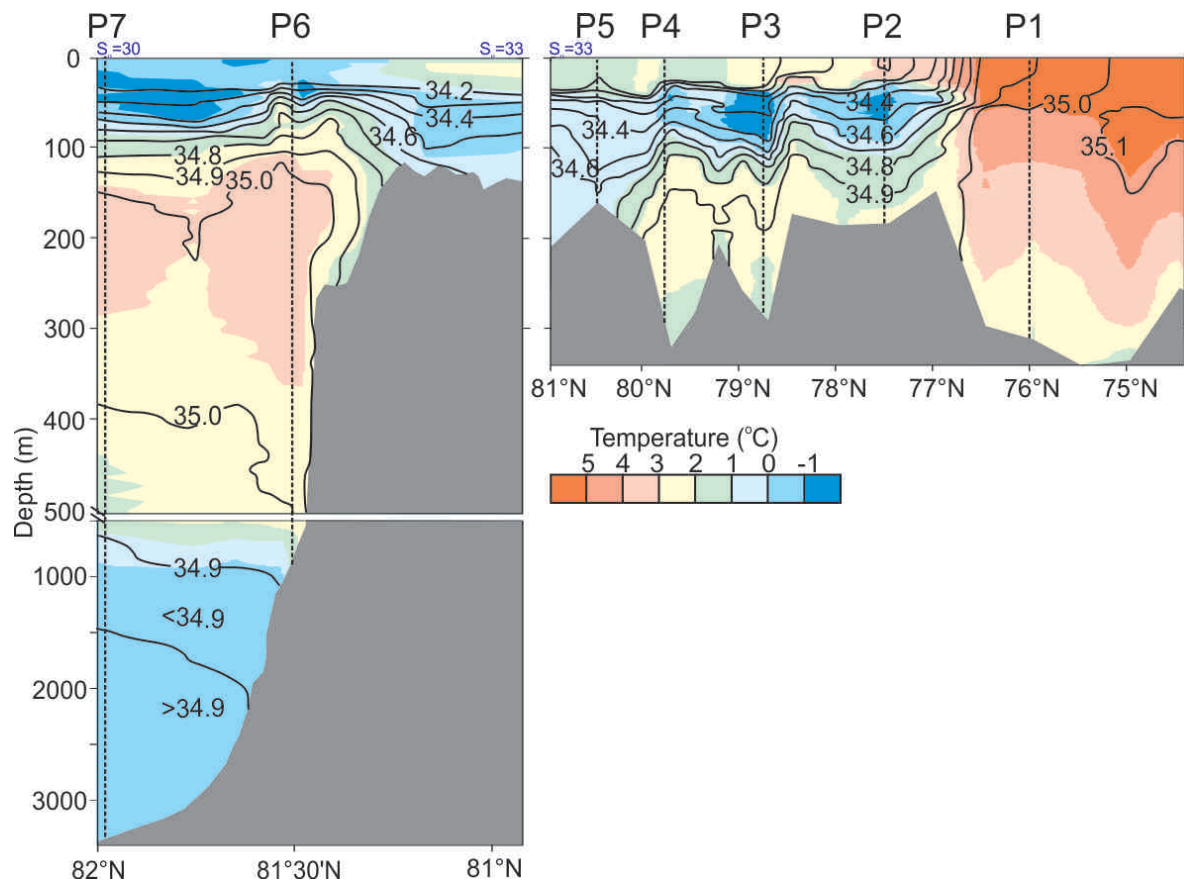
**P3** – located in the trench north of Storbanken. P3 will likely be characterized of Arctic conditions in the upper part water column and a deep northeastward flow of Atlantic Water (from the branch entering the southern Barents Sea) in the lower part of the water column. P3 is likely to have varying sea ice concentration during winter, and a surface layer of meltwater during summer. Being in a deeper trench, P3 is expected to have suitable sediments for geological coring.

**P4** – located in the deeper trench south of Kvitøya. P4 will likely be characterized of Arctic conditions in the upper part water column and a deep southwestward flow of Atlantic Water (from the branch going around Svalbard) in the lower part of the water column. It is expected that P4 will be covered with sea ice most of the winter, and by a surface layer of meltwater during summer. Being in a deeper trench, P4 is expected to have suitable sediments for geological coring.

**P5** – located on the shallow shelf northeast of Kvitøya. P5 is likely to have Arctic conditions below the seasonal varying surface layer. It is expected that P5 will be covered with sea ice most of the winter, and by a surface layer of meltwater during summer.

**P6** – located at the shelf-break slope (at about 850m) towards the Arctic Ocean. P6 is situated in the core of the Atlantic Water flow in the shelf-break current. It is expected that P6 will have a varying sea ice cover during winter, and a varying surface layer of meltwater during summer. ATWAIN-moorings (not shown in map) can provide year-long measurements for P6. P6 might be suitable for geological coring.

**P7** – Located in the deeper Arctic Ocean. P7 is suitable for comparing the shallow Barents Sea with the deeper Arctic Ocean. P7 will have extensive sea ice coverage during winter, and varying sea ice cover during summer. P7 might be suitable for geological coring.



**Fig. 2** Temperature (color) and salinity (black solid lines) distribution in the Nansen LEGACY transect sampled in August 2012. Note different scales on the horizontal axes. The location of the process study stations (P1-7) is shown with dashed vertical lines.

**Tab. 1** Next two pages: Overview of Nansen Legacy transect – stations with coordinates and bottom depth. Blue labelled indicating the process stations. Comment section mentioning projects involved or/and location geography information.

## Nansen LEGACY transect - stations

Station name	Longitude (decimal)	Latitude (decimal)	Longitude (degrees)	Latitude (degrees)	Depth (m)	Type of station	Comment
NLEG25	30,0000	82,0000	030 00.00 E	82 00.00 N	3000	Process study station P7	
NLEG24	30,5258	81,6828	030 31.55 E	81 40.97 N	2807		<i>A-TWAIN</i>
NLEG23	30,6647	81,6165	030 39.88 E	81 36.99 N	1913		<i>A-TWAIN</i>
NLEG22	30,7667	81,5895	030 46.00 E	81 35.37 N	1551		<i>A-TWAIN</i>
NLEG21	30,8548	81,5463	030 51.29 E	81 32.78 N	865	Process study station P6	<i>A-TWAIN, shelf-break</i>
NLEG20	30,9618	81,5025	030 57.71 E	81 30.15 N	698		<i>A-TWAIN, shelf-break</i>
NLEG19	31,0775	81,4580	031 04.65 E	81 27.48 N	486		<i>A-TWAIN, shelf-break</i>
NLEG18	31,1448	81,4318	031 08.69 E	81 25.91 N	264		<i>A-TWAIN, shelf-break</i>
NLEG17	31,2468	81,4107	031 14.81 E	81 24.64 N	204		<i>A-TWAIN, shelf-break</i>
NLEG16	31,2933	81,3822	031 17.60 E	81 22.93 N	189		<i>A-TWAIN, shelf-break</i>

NLEG15	31,3487	81,3098	031 20.92 E	81 18.59 N	195		<i>Arctic Price near-shelf-station</i>
NLEG14	34,0000	81,0000	034 00.00 E	81 00.00 N	216		<i>Vardø-N, Kvitøybanken</i>
<b>NLEG13</b>	<b>34,0000</b>	<b>80,5000</b>	<b>034 00.00 E</b>	<b>80 30.00 N</b>	<b>167</b>	<b>Process study station P5</b>	<b><i>Vardø-N, Kvitøybanken</i></b>
NLEG12	34,0000	80,0000	034 00.00 E	80 00.00 N	209		<i>Vardø-N, Kvitøybanken</i>
<b>NLEG11</b>	<b>34,0000</b>	<b>79,7500</b>	<b>034 00.00 E</b>	<b>79 45.00 N</b>	<b>332</b>	<b>Process study station P4</b>	<b><i>Vardø-N, trench east of Kong Karl</i></b>
NLEG10	34,0000	79,5000	034 00.00 E	79 30.00 N	293		<i>Vardø-N, trench east of Kong Karl</i>
NLEG09	34,0000	79,2500	034 00.00 E	79 15.00 N	215		<i>Vardø-N, trench east of Kong Karl</i>
NLEG08	34,0000	79,0000	034 00.00 E	79 00.00 N	266		<i>Vardø-N, trench east of Kong Karl</i>
<b>NLEG07</b>	<b>34,0000</b>	<b>78,7500</b>	<b>034 00.00 E</b>	<b>78 45.00 N</b>	<b>301</b>	<b>Process study station P3</b>	<b><i>Vardø-N, trench east of Kong Karl</i></b>
NLEG06	34,0000	78,5000	034 00.00 E	78 30.00 N	180		<i>Vardø-N, Storbanken</i>



NLEG05	34,0000	78,0000	034 00.00 E	78 00.00 N	193		<i>Vardø-N, Storbanken</i>
<b>NLEG04</b>	<b>34,0000</b>	<b>77,5000</b>	<b>034 00.00 E</b>	<b>77 30.00 N</b>	<b>190</b>	<b>Process study station P2</b>	<b><i>Vardø-N, Storbanken</i></b>
NLEG03	34,0000	77,0000	034 00.00 E	77 00.00 N	154		<i>Vardø-N, Storbanken</i>
NLEG02	31,2200	76,5000	031 13.20 E	76 30.00 N	308		<i>Vardø-N, Storbanken</i>
<b>NLEG01</b>	<b>31,2200</b>	<b>76,0000</b>	<b>031 13.20 E</b>	<b>76 00.00 N</b>	<b>322</b>	<b>Process study station P1</b>	<b><i>Vardø-N, Høpendjupet</i></b>

## 5 Bridge-based observations

### 5.1 ICE OBSERVATIONS

<http://www.climate-cryosphere.org/media-gallery/881-icewatch-assist>

Photos can be uploaded in the software directly.

## 6 Underway sensors/measurements

### 6.1 SURFACE WATER PARTIAL PRESSURE OF CO<sub>2</sub> (PCO<sub>2</sub>)

**Measured parameter:** mole fraction of carbon dioxide ( $x_{CO_2}$ ), partial pressure of CO<sub>2</sub> ( $p_{CO_2}$ ,  $\mu\text{atm}$ ) and fugacity of CO<sub>2</sub> ( $f_{CO_2}$  ( $\mu\text{atm}$ ))

**Method responsible:** Agneta Fransson (NPI, [agneta.fransson@npolar.no](mailto:agneta.fransson@npolar.no)) and Melissa Chierici (IMR, [Melissa.chierici@hi.no](mailto:Melissa.chierici@hi.no))

**Description of parameter:** Partial pressure of CO<sub>2</sub> is the dissolved CO<sub>2</sub> in seawater and atmosphere.

**Methodological description:**

Surface water  $x_{CO_2}$  (or  $p_{CO_2}$ ,  $f_{CO_2}$ ) is continuously measured from the ships' seawater intake at 4 meter using the instrumentation of General Oceanics® (showerhead equilibration and dispersed infrared detection). Discrete water samples are collected regularly to be analysed regarding DIC and AT (see section 8.2) for quality control of the instrument data. Measurements of atmospheric  $p_{CO_2}$  are performed during a 24-hour cycle. A set of four standard gases of different CO<sub>2</sub> concentrations (0, 350, 450, 600  $\mu\text{atm}$ ) are analysed in the 24-hour cycle and used for calibration of the measurements.

Seawater salinity and temperature are measured by a TSG Seabird sensor and will be logged by the  $p_{CO_2}$  instrument and used in the calculations of  $p_{CO_2}$ .

## 6.2 SURFACE WATER DISSOLVED OXYGEN

**Measured parameter:** dissolved oxygen (DO, O<sub>2</sub> μmol/kg),

**Method responsible:** Agneta Fransson (NPI, agneta.fransson@npolar.no) and Melissa Chierici (IMR, melissa.chierici@hi.no)

**Description of parameter:** Dissolved oxygen is the oxygen gas dissolved in seawater.

**Methodological description:**

Dissolved oxygen is continuously measured from the ships' seawater intake at 4 meter using an Optode from Aanderaa®. Oxygen concentration, saturation and water temperature are logged in the pCO<sub>2</sub> data log.

## 7 Water column structure

### 7.1 CTD

**General requirements:**

As of 26 July 2018, the KPH CTD is equipped with double set of temperature and conductivity sensors, pressure sensor, oxygen and fluorescence sensors, and an altimeter. To be installed are a turbidity and a PAR sensor.

Annual calibration of all CTD sensors (in particular T, S, and O<sub>2</sub>) should be documented through calibration sheets available on request. Samples for calibration of the conductivity cell(s) should be taken regularly during a research cruise covering the observed salinity range. This might require several samples per CTD cast.

Setup of the CTD and postprocessing follows standard IMR routines. Raw data (ie. .hex-files and configuration files) should be available for own postprocessing e.g. in case conversion to other units or different depth bins is required, or LADCP postprocessing requires lat&lon information throughout the cast.

If LADCPs are mounted on the rosette, GPS position from the NMEA feed should be recorded throughout the cast: in Seasave, choose the setting to append lat&lon to every scan. As of 26 July, this setting was in place.

Metadata of the cast should be recorded in the CTD file and on the CTD sampling sheet.

### **Information to be logged:**

For each cast, information to be noted down:

- date & time (UTC)
- position at start, bottom, and end
- bottom depth (in meter)
- operator
- ship
- sensor type incl. serial number for each component
- software used e.g. for SBE instruments incl version number
- meteorological conditions (barometric air pressure at sea level, wind speed & direction (degrees), air temperature (deg C), cloud cover (in 10th)

In case of extensive water sampling of CTD casts, a sampling log sheet should be used for overview of type of water sample taken and sample number (see Appendix for template).

### **Deployment routines:**

- Start data acquisition just before the CTD leaves the deck (this will help with assessing surface pressure adjustment).
- Soak for 1 minute at 5 m (10 m if very cold and there is a risk of freezing during deployment or on deck), bring back up to surface (ie. just submerged, rosette/CTD frame not breaking through the sea surface), leave there for 3 minutes.
- Lower CTD to max depth. Rest at max depth for at least 1 minute (preferably longer).

- Lowering speed: between 0.8 and 1 m/s. If LADCP is mounted, 0.7 m/s. Take care not to hit the bottom with the CTD but stop 5-10 m above ground, depending on conditions (steepness of topography, drift speed of the ship). Use the altimeter on the CTD to assess distance to bottom.
- Depending on capacity for measuring salinity samples onboard, water samples should be taken at various depths throughout the CTD cast. Suggested minimum number of samples is 3 – one at bottom/max depth, one in the middle of the water column in a region without strong salinity gradient, and one in the surface mixed layer. More samples will improve accuracy of the calibration. Depth should be chosen to cover the range of salinities and pressure throughout the cast/cruise.
- If water samples for other variables are taken at standard depths (e.g. following protocols from the Nansen Legacy project, salinity samples can be taken at some of those depths.
- If salinity samples are measured throughout the cruise, at least 5 samples should be taken from each cast.
- Close Niskin bottles on upcast: stop CTD at sampling depth (do NOT fire “on the fly”!), wait at least 1 minute, preferably 2 minutes, then fire Niskin bottle. Flushing time (i.e. wait before closing the bottle) should be longer in calm conditions and for big rosette systems or Niskin bottles with small openings.
- Fill in depths of the bottles on the log sheet and send the log sheet to the CTD sampling crew as soon as possible.
- Stop data acquisition when the CTD is back on deck.

## CTD log sheet template

Cruise:	Date/Time:
CTD #:	Station name:
Bottom depth:	Observer:
Latitude:	Longitude:
Comments:	

Niskin #	1	2	3	4	5	6	7	8	9	10	11	12
Depth (m)												
Ct/At												
18O												
CDOM												
TOC												
DMSP												
Nutrients												
Ammonium												
Salinity												
Chl a												
POC/PON												
TPP												
FCM												
SEM												
XRF												
BP												
DNA												
Casy												

Niskin #	13	14	15	16	17	18	19	20	21	22	23	24
Depth (m)												
Ct/At												
18O												
CDOM												
TOC												
DMSP												
Nutrients												
Ammonium												
Salinity												
Chl a												
POC/PON												
TPP												
FCM												
SEM												
XRF												
BP												
DNA												
Casy												

## 7.2 ADCP

**General requirements:** There are four ADCPs mounted: two 38 kHz and two 150 kHz RDI Ocean Surveyors. One of each are located on a drop keel, the other ones are in the hull (aka Arctic window aka flush mounted). There are two PCs to control them, one per frequency, dual boot to reach drop keel or flush mounted instrument.

→ You can run only one of the 150kHz and one of the 38kHz together, but not both 150kHz or both 38kHz ADCPs.

You can access the PCs from any of the work stations in the instrument room, use shift-shift-o to change between computers.

Something to remember: If you want to use the 38 kHz, turn off the 38 kHz frequency of the EK80. Likewise, if the EK80 takes priority, do not use the 38 kHz ADCP, there is significant interference both ways.

### Configuring the ADCPs:

Configuration files for standard setup are stored in a folder on the desktop on each PC/boot.

There are 2x4 configuration files to cover:

- Narrowband versus Broadband
- Bottom track on versus off
- Synchronization through the K-Sync unit or standalone pinging.

Default setup should be:

- for ADCP only use: Narrowband, bottom track on;
- for concurrent ADCP/EK80 use: Narrowband, bottom track off.

In both cases:

- For 38 kHz ADCP: bin depth = 24 m, 16 m blanking distance, 65 bins
- For 150 kHz ADCP: bin depth = 8 m, 4 m blanking distance, 65 bins



Some of the settings in the configuration files might need adjusting:

1. Draft of the boat:

Varies between minimum 7.2 m and maximum 8.5 m → check on bridge and adjust in the configuration files (command: ED).

Might need adjusting during a cruise if ballasting changes significantly, so check draft regularly.

If drop keel is extended, add the additional draft (max 3.4 m) → display in instrument room. There should be an event log when the drop keel is deployed and taken up again.

2. Set salinity to something sensible. It's set to 35 in the configuration file – adjust there if needed (command: ES)

**→ NOTE: Make a copy of the standard config files and do the changes in the copy!**

The rest of the configuration and starting and stopping of the ADCPs are done in VmDas. An extensive guide for VmDas settings is available on the ADCP PCs. Contact the instrument technicians for help.

## 8 Water samples from Niskin bottles

The order of sampling from the Niskin bottles (see 6.2 Niskin Rosette) should be decided on as some samples need to be taken immediately. Here one should also agree on some general rules when sampling from Niskin bottles, e.g. use of Nitril gloves.

All water samples taken from the ships Niskin bottles should be described in an own sub-chapter.

## 8.1 SALINITY SAMPLES

For sampling of salinity samples.

**Method responsible:** Angelika Renner (IMR, angelika.renner@hi.no)

(description of Salinometer will come when instrument is installed on KPH)

## 8.2 SAMPLING OF DIC, AT AND PH

Sampling of DIC/pH from the Niskin-bottle rosette will take place first (if no other sensitive gases are sampled, such as dissolved oxygen). From the Niskin bottle, use a tubing to gently fill a 250 ml borosilicate bottle (glass bottle with blue plastic cap) to avoid air bubbles, overfill 1-2 volumes for rinsing and removing air bubbles.

### 8.2.1 Total dissolved inorganic carbon (DIC)

**Measured parameter:** Total dissolved inorganic carbon (DIC,  $\mu\text{mol/kg}$ )

**Method responsible:** Melissa Chierici (IMR, melissa.chierici@hi.no) and Agneta Fransson (NPI, agneta.fransson@npolar.no)

**Description of parameter:** Total dissolved inorganic carbon measures the sum of bicarbonate, carbonate and carbonic acid and dissolved  $\text{CO}_2$  (the sum of carbonic acid and  $\text{CO}_2$  is generally referred as  $\text{H}_2\text{CO}_3^*$ ) in seawater, melted sea ice and brine, snow. Other abbreviations that are used instead of DIC are  $\text{TCO}_2$  and CT.

**Methodological description:**

→ **Special laboratory requirements:**

- Dry-lab with as constant temperature as possible. 3 meters of bench place, with space on top of bench (preferably no cupboards) and room under bench for circulating water baths. Room needs a sink for seawater waste.

- Nitrogen gas (20 L cylinder at 200 bar) to be secured near the instrument to allow control and short distance.
- Refrigerator on short distance or in room, access to MQ water

→ **Sampling depths:**

→ **Chemicals used:** 10% phosphoric acid, cathode and anode solution (DMSO and thymol blue) potassium iodide salt (KI), nitrogen gas (high-quality)

DIC will be sampled and analysed directly onboard KPH and follow the state-of-the-art method described in Dickson et al. (2007). DIC was determined using gas extraction of acidified samples followed by coulometric titration and photometric detection using a Versatile Instrument for the Determination of Titration Alkalinity (VINDTA 3D, Marianda, Germany). Accuracy of the measurements is ensured by routine analyses of Certified Reference Materials (CRM, provided by A. G. Dickson, Scripps Institution of Oceanography, USA). Precision is derived from repeated measurements on a daily basis.

### 8.2.2 Total alkalinity (AT)

**Measured parameter:** Total Alkalinity (AT,  $\mu\text{mol/kg}$ )

**Method responsible:** Melissa Chierici (IMR, melissa.chierici@hi.no) and Agneta Fransson (NPI, agneta.fransson@npolar.no)

**Description of parameter:** Total alkalinity (AT) is a measure of the buffer capacity of a seawater towards acidic or basic input. Other commonly used acronyms is TA.

**Methodological description:**

→ **Special laboratory requirements:** Dry-lab with as constant temperature as possible. 2 meters of bench place, with space on top of bench (preferably no cupboards) and room under bench for circulating water baths. Room needs a sink for seawater waste.

→ **Sampling depths:**

→ **Chemical used:** Hydrochloric acid (0.1 N), electrolyte solution (saturated potassium chloride, KCl).

Sampling and analyses of AT will take place onboard and be determined by potentiometric titration with 0.05 N hydrochloric acid (HCl) using a Titrand (Metrohm, Swiss) system with a Dosino (Metrohm) to allow for precise volume addition (sample volume 40 ml). The equilibration point is evaluated using a Gran evaluation in addition to end-point detection in the Tiamo software (Metrohm). Accuracy of the measurements is ensured by routine analyses of Certified Reference Materials (CRM, provided by A. G. Dickson, Scripps Institution of Oceanography, USA). Precision is derived from repeated measurements on a daily basis.

A selection of duplicate samples (20-40 samples) will be stored and analysed post-cruise at the IMR laboratory in Tromsø for quality and consistency check using the state-of-the-art instrumentation for potentiometric titration in a closed cell (100 ml) and 0.1 N HCl on a Versatile Instrument for the Determination of Titration Alkalinity (VINDTA 3S, Marianda, Germany).

### 8.2.3 pH

**Measured parameter:** pH (total scale, spectrophotometric)

**Method responsible:** Melissa Chierici (IMR, melissa.chierici@hi.no) and Agneta Fransson (NPI, agneta.fransson@npolar.no)

**Description of parameter:** pH is a measure of the acidity (hydrogen ion concentration/activity) of a seawater

**Methodological description:**

→ **Special laboratory requirements:** Dry-lab with as constant temperature as possible. 2 meters of bench place, with space on top of bench (preferably no cupboards). Room needs a sink for seawater waste.

→ **Sampling depths:**

→ **Chemical used:** m-cresol purple (2 mM solution)

Sampling and analyses of pH will take place onboard and is determined spectrophotometrically (Diode array spectrophotometer, type for ex: HP8453, Cary (former Agilent) using a 2mM solution of the sulfonaphtalein dye m-cresol purple as an indicator (Clayton and Byrne, 1993). Perturbation of indicator pH was corrected using the formulation described in Chierici et al. (1999).

### 8.3 SAMPLING FOR $\Delta^{18}\text{O}$ (DELTA-O-18)

**Measured parameter:**  $\delta^{18}\text{O}$  (or delta-O-18)

**Method responsible:** Mats Granskog (RF1, NPI, mats.granskog@npolar.no), Agneta Fransson (RF2, NPI, agneta.fransson@npolar.no)

**Description of parameter:**  $\delta^{18}\text{O}$  (or delta-O-18) is a measure of the ratio of stable isotopes oxygen-18 ( $^{18}\text{O}$ ) and oxygen-16 ( $^{16}\text{O}$ ). It is commonly used with measurement of salinity of seawater to infer the amount of different freshwater sources in a seawater sample (sea-ice melt water or river/glacial water).

**Methodological description:**

→ **Special requirements/gear:**

→ **Sampling depths** Standard depths (5, 10, 25, 50, 75, 100 and 200 m) and DCM. Collect from same Niskin and same depths as DIC/TA.

→ **Chemicals used:**

Materials:

- Plastic (HDPE) bottle (15ml) with plastic caps (VWR number 215-7503, Figure 1).
- Parafilm (50mm × 50mm squares)
- Labels

### Method:

Bottle is completely filled with seawater and cap closed tightly. Afterwards the vial must be sealed with Parafilm. Large headspace (of air) will contaminate the sample during storage.

- 1) Fill the bottle with seawater from the Niskin bottle. As full as possible to leave as little air inside bottle as possible.
- 2) Close the cap without touching the inside. Turn bottle upside down, if there is a little bubble of air it is ok.
- 3) Dry the outside of the cap and the bottle. Tighten the cap.
- 4) Seal the bottle cap with Parafilm. The Parafilm must be stretched **tightly** around the cap. If it is loose it will fall off. Practice applying Parafilm to an empty vial until you can do it securely. It helps to warm the parafilm for 5 seconds between the palms of your hands to make it stretch better without breaking.
- 5) Label sample (preferable before sampling, to make sure label attaches well).

→ **Sample storage / Shipment address** Store the  $\delta^{18}\text{O}$  samples at +4°C in dark (in refrigerator onboard). Room temperature storage is fine if bottles are well sealed. DO NOT FREEZE!

**Shipment:** Norsk Polarinstitut  
Framsenteret  
Hjalmar Johansens gate 14  
9007 Tromsø  
  
ATT: Mats Granskog/Agneta Fransson



*Fig. 1 Bottle and cap*

## 8.4 TOTAL ORGANIC CARBON (TOC)

**Measured parameter:** Quantification of total and dissolved organic carbon ( $\text{mg C L}^{-1}$ ).

**Method responsible:** Murat Van Ardelan (NTNU, [murat.v.ardelan@ntnu.no](mailto:murat.v.ardelan@ntnu.no))

**Description of parameter:**

**Methodological description:**

- **Special requirements/gear:** Drying oven, pre-combusted GF/F filters, pre acid-cleaned glass vials
- **Sampling depths:** 3 depths (surface, midwater column and near bottom) corresponding to the depths for DOM/C
- **Chemicals used:** HCL 30%, H<sub>3</sub>PO<sub>4</sub> (35%)

Method

All the 40ml vials used for the sample collection of TOC were cleaned as follows (gloves, goggles, and lab coat were used at all times, the cleaning was done under a fume hood when needed):

1. Remove paper, plastic, or marker labels from all vials
2. Immerse the vials in a HCL 30% bath for at least 8 hours
3. Rinse the vials three times with MiliQ water
4. Dry the vials in a drier until completely dry, usually around 2 hours at 80°C
5. Wrap the vials with aluminium paper in packages small enough to be placed inside a combustion oven
6. Combust the vials in an oven at 450°C for 8 hours

The vials plastic caps were cleaned separately with the following procedure (gloves, goggles, and lab coat were used at all times, the cleaning was done under a fume hood when needed):

1. Place the caps in a HCL 30% bath for about ten minutes
2. Transfer the caps into a methanol bath (do not rinse after the HCL bath with MiliQ water to avoid contamination)
3. Leave the caps in the methanol bath from 6 to 8 hours
4. Take the caps out of the methanol bath and place them in a semi-closed (to allow evaporation) aluminium foil foiled container
5. Place the caps to dry in a drier at 60°C for 2 hours or until completely dry
6. Transfer the caps to a plastic bag and keep them sealed until needed

TOC samples directly transfer, without filtration, to 40ml pre-rinsed (3x with filtered water) glass vial (QEC 2112-40mlE) and filled up to  $\frac{3}{4}$  of its capacity. The vials were stored in a freezer at -20°C.

\*\*\*In case of dissolved organic carbon, DOC sampling; The water samples (DOC) was filtered with glass fibre filters GF/F 0.7µm (Whatman, 1825-047) utilizing a vacuum filtration system with a 250ml filter holder (Sartorius, filter holder 16309) and a Büchner Flask. The DOC samples will be preserved similarly as TOC samples

The TOC and DOC samples were analysed by using a TOC analyser Apollo 9000 HS TOC-instrument (Tekmar Dohrman, Serienr. 01061005190B1048).

→ **Samples storage/shipment address:** the samples should be stored in a freezer at at -20°C

\*\*\* TOC samples can also be preserved by adding 200µl H<sub>3</sub>PO<sub>4</sub> (35%) to 40 ml subsamples and kept in dark and 4°C



## 8.5 PARTICULATE ORGANIC CARBON (POC) AND NITROGEN (PON)

**Measured parameter:** Quantification of particulate organic carbon and nitrogen (in  $\mu\text{g C}$  or  $\text{N L}^{-1}$ ).

**Method responsible:** Marit Reigstad (UiT, [marit.reigstad@uit.no](mailto:marit.reigstad@uit.no)), Gunnar Bratbak (UiB, [gunnar.bratbak@uib.no](mailto:gunnar.bratbak@uib.no)), Murat Van Ardelan (NTNU, [murat.v.ardelan@ntnu.no](mailto:murat.v.ardelan@ntnu.no) – protocol responsible)

**Description of parameter:**

**Methodological description:**

- **Special requirements/gear:** Drying oven, pre-combusted GF/F filters
- **Sampling depths:** Standard depths 5, 10, 25, 50 75, 100 and DCM
- **Chemicals used:** none

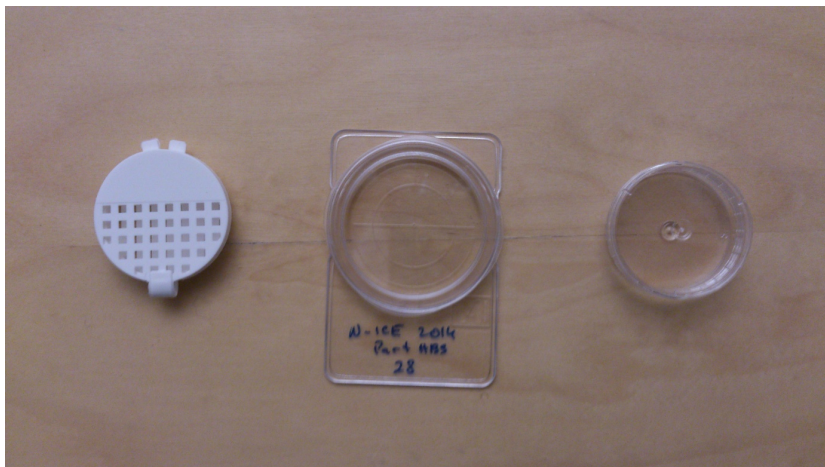
**Method:**

- Collect seawater from the Niskin bottles from standard depths down to 100 m. Rinse the plastic sampling bottle with sample water (~100 ml) before collecting the sample.
- Remember to gently mix the bottle (turn upside down for a couple of times) before filtering to ensure that no particles settle down (results in uneven concentration if subsampling the sampling bottle).
- Be sure to have placed the filter in the middle of the filter holder and that the funnel is thoroughly placed on top of it (if something is leaking the exact volume filtered or the filtration area on the filter is not known – these are needed for the calculations later).
- Filter ca. 50-2000 ml (depending on biomass – a light colour on the filter is enough) from each depth through pre-combusted 25 mm GF/F filters.
- Use low vacuum pressure (about -30 kPa). Always have the valve of the filtering funnel closed before turning the pump on or off.
- Cover the funnels with tin foil when filtering. If you expect to filter 1 L or 2 L, you can place the respective plastic bottle into the funnel and let it

run. Ideally the 0.5 and 1 L mark should be indicated on the plastic sampling bottles.

- Rinse the funnel with filtered seawater (collect filtered sea water from previous filtrations) once the sample has been filtered. Do not let the filters dry out, close the valve.
- After filtration, each GF/F filter should be directly placed into Pall filter slides (see picture below) and dried at 60°C in a drying oven. Wrap filter slides from one station in tin foil and keep them in a labelled Ziploc bag.
- Rinse the filtration equipment with MilliQ before the next sample. Cover filtration funnel with tin foil when not in use (to avoid dust).
- For each sampling day or event, prepare a blank filter by filtering MilliQ water through a pre-combusted GF/F filter (similar volume than sea water for the samples) and treating it the same way than the samples. The blank filters get normal sample running number (but make an additional note "MilliQ" on the sample label/analysis slide) and are noted in the filtering protocol and log sheet. Make also a note on CTD log sheet to avoid confusion with numbering on following casts.

→ **Samples storage/shipment address:** POC/N samples should be wrapped in tin foil and stored at -20 C until further processing at UiT and UiB.



*Fig. 1 Petri slide (middle) for storage of POC/N filters*

## 8.6 TRACE METAL (TM) AND DISSOLVED ORGANIC MATTER CHARACTERIZATION (DOM) SAMPLING

**Measured parameter:** Dissolved organic matter (DOM)

**Method responsible:** Murat Van Ardelan (NTNU, [murat.v.ardelan@ntnu.no](mailto:murat.v.ardelan@ntnu.no))

**Description of parameter:** Qualitative analysis of the major components and distribution of dissolved organic matter at discrete depths.

**Methodological description:**

→ **Special requirements/gear:**

- Standard Rosette sampler with Niskin bottles
- Clean environment not required. Bench space with sink necessary for filtration and pre-concentration
- Ca 1.5 m<sup>2</sup> bench space is needed
- Deep freeze space (ca 50x50x100 cm)
- Refrigeration space (ca 50x50x50 cm)

→ **Sampling depths:**

→ **Chemicals used:** Methanol (washing and HPCL grade), Hydrochloric Acid (32 %)

Materials

Use glass for all materials if possible

- Funnels or Tubing: To collect from the GO-Flo/ Niskin Rosette
- Volumetric Flasks (2.5-10 L): To collect from the GO-Flo/ Niskin Rosette. 1 per depth + spares

**Filtration system:** (ideally 2 setups for replicates)

- Vacuum or water pump
- Glass funnels (500-1000 ml) (2):

- Clamps (2): To hold the flask the filter and the funnel
- Frits 47 mm (2): for filters
- Filtration Vacuum Flasks (2 L): to collect the filtrated seawater.
- Pre-concentration flask (2-4 L): for setting the C-18 columns
- GF/C Filters (47 mm): Pre-combusted filters at 450°C for 8 h in Aluminum packages

#### **Pre-concentration system:**

- Peristaltic pump: Peristaltic tubing black-black (diameter 0.90 mm or 0.86 mm)
- Glass pipettes (10 ml): To place inside the flasks and connect to the tubing and the C18 Columns. Six to connect to conduct simultaneous filtration of 3 depths with duplicates.
- Silicon Tubing
- Chromatographic columns: C18 Sep-Pak plus

#### **Extraction system:**

- Extracting setup/rack: custom-made rack to place the Ch. Columns for extraction
- Scintillation vials (20ml): for extraction

#### **Material washing and cleaning:**

- Glass vials: (Glassware in general)
- Immerse the vials in a HCl 30% bath for at least eight hours.
- Rinse the vials three times with MilliQ water.
- Dry the vials in a drier until completely dry, usually around two hours at 80°C.
- Wrap the vials with aluminum paper in packages to be placed inside a combustion oven
- Combust the vials in an oven at 450°C for eight hours

The plastic caps of the vials were cleaned separately with the following procedure:

- Place the caps in a HCl 30% bath for about ten minutes
- Transfer the caps into a methanol bath (do not rinse after the HCl bath with MiliQ water)
- Leave the caps in the methanol bath from six to eight hours.
- Take the caps out of the methanol bath and place them in a semi closed (to allow evaporation) aluminum foil foiled container
- Place the caps to dry in a drier at 60°C for two hours or until completely dry
- Transfer the caps to a plastic bag and keep them sealed until needed

#### **Procedure:**

Collection of seawater from the Rosette is performed on the glass bottles, avoiding using extra tubing if possible (depending on glass volume).

#### **After collection of volume of seawater:**

- 3 replicate of 50 ml TOC samples are collected in (clean pre-combusted) glass vials (do not fill to max, leave out enough headspace). Samples will be acidified with HCl (pH ~ 2) and preserved in deepfreeze (-20°C).
- Ca 2000- 3000 ml seawater is filtered through pre-combusted clean GF/C filters, which are stored in the deepfreeze for POC analysis.
- The filtrated seawater is acidified to pH ~2 using 3M or 32% HCl (reagent grade).
- In order to eliminate impurities, use the peristaltic pump to rinse with 5 ml methanol (HPLC grade) the chromatographic columns (C-18) and the glass pipettes. Start by the columns.

- Proceed to extraction at a rate of ~10 ml /min. Make sure to cover the mouth of the glass container with aluminum foil to prevent any kind of contamination to the DOC filtrate.
- DOC accumulated in the column should not be stored refrigerated but extracted immediately!
- After extraction flush the columns with 0.1 M HCL (10 -12 ml) and MQ water.
- Extraction is carried by flushing each column with methanol in 10 ml (small syringes). The extract will be kept in clean pre-combusted glass vials in refrigeration (4°C)

#### Ancillary measurements:

- TOC: 3 replicates in 40 ml vials filled  $\frac{3}{4}$  and frozen
- POC: Volume filtered in the 47 mm filters will be used for this analysis
- Glass vials (40ml): Pre-combusted at 450°C for 6rs in Aluminum packages

#### 8.6.1 DOC-characterization

**Measured parameter:** Dissolved organic carbon (DOC)

**Method responsible:** Murat Van Ardelan (NTNU, [murat.v.ardelan@ntnu.no](mailto:murat.v.ardelan@ntnu.no))

**Description of parameter:** Characterization of dissolved organic matters, its lability for bacterial

decomposition, its recalcitrant/refractory character. Its elemental ratios (C/O, C/N and C/H)

#### Methodological description:

→ **Special requirements/gear:** Standard Rosette sampler with Niskin bottles can be used this sampling. No need special clean environment but a bench space near to sink s necessary for filtration & pre-concentration on the chromatographic column activities

→ **Sampling depths:** !!! *Subject to change depending on context, physical and biological in situ measurements* temporary depths; surface, 5, mid-depth and ca 2 m above sediment water interface

→ **Chemicals used:** HCl or H<sub>3</sub>PO<sub>4</sub> (35%)

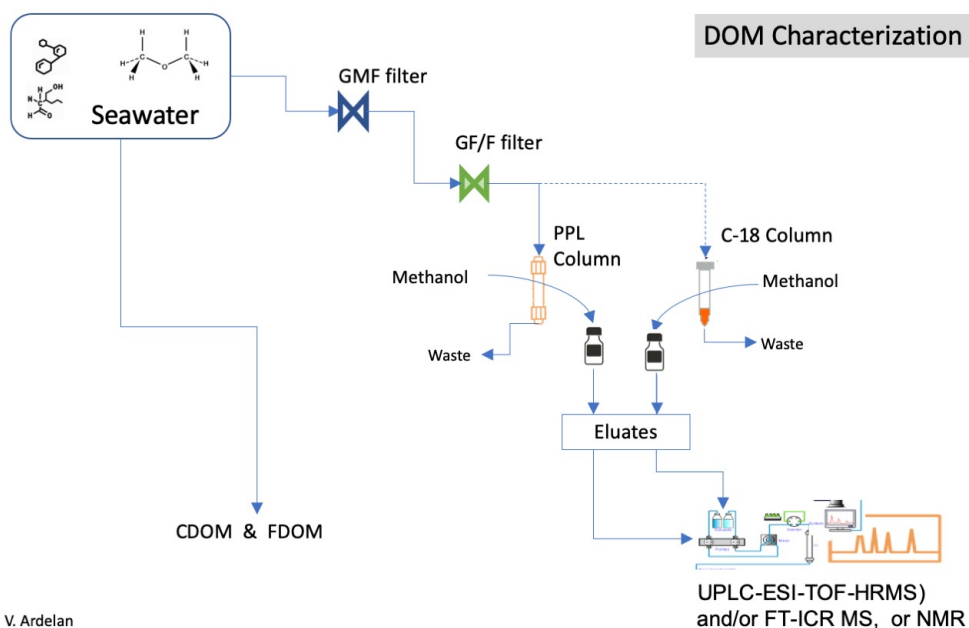
#### Material:

- vacuum pumps
- peristaltic pumps
- filtration set ups
- pre-concentration set ups
- large glass jars/flasks
- Ca 1.5 m<sup>2</sup> bench space is needed
- deepfreeze Space (ca 50x50x100 cm)
- refrigerator Space (ca 50x50x50 cm)

#### Method:

- After collection of ca 2.5 Liter seawater 3 replicates of 50 ml TOC samples will be
- acidified with either HCl (or H<sub>3</sub>PO<sub>4</sub>, 35%, 250 µl to 50 ml) in glass vial preserved in
- refrigerator (see 7.5 TOC protocol for the details).
- Ca 2000 ml SW will be filtrate with GF-F filter and acidified to pH 2 (see Fig 1)-if there is
- high productivity in the sampling spots, use GFM prefiltration before GF-F filtration
- Acidify the filtrated seawater with UP HCL (12 M) bring pH to 2.0.
- Rinsed PPL and C-18 columns with 6ml of ultrapure methanol in order to eliminate
- impurities before placing them inside the sample.
- Acidified SW will run through columns (PPL, (Agilent, Bond Elut-PPL) and/or C-18
- (Water)) with help of peristaltic pumps (see Fig.1) with a flow rate about 2-3 ml/s.
- Rinsed the column with 5ml of HCl 0.01M in order to eliminate the salt residue from the

- column.
- Extract the organic compounds from column by using twice with 5ml of ultrapure
- methanol (total 10 ml) with help of plastic syringe; the columns were put on a support
- while applying methanol for extraction, and left the extraction methanol to drip into a
- 40 ml pre cleaned and combusted glass vials.
- The extracted samples in the vials should be kept in refrigerator and dark until the
- analysis with LC-MS / FT-ICR-MS in the NTNU



Murat V. Ardelan

*Fig. 1 Set up of solid phase extraction (SPE) with PPL and/or C-18 column.*



## 8.7 SAMPLING FOR CDOM

**Measured parameter:** Colored (or chromophoric) dissolved organic matter (CDOM)

**Method responsible:** Mats Granskog (RF1: NPI, mats.granskoog@npolar.no), Børge Hamre (RF1: UiB, borge.hamre@uib.no), Murat V. Ardelan (RF2: NTNU, murat.v.ardelan@ntnu.no)

**Description of parameter:** Colored (or chromophoric) dissolved organic matter (CDOM) for characterization of marine dissolved organic matter (DOM) using optical measurements (absorbance and fluorescence). DOM is here defined as that passing through a nominal 0.22  $\mu\text{m}$  pore size membrane filter. Absorption is important for the optics of water masses (RF1) and fluorescence is used to characterize the material (RF2).

**Methodological description:**

→ **Special requirements/gear:**

→ **Sampling depths:** Standard depths (5, 10, 25, 50, 75, 100 and 200 m) and DCM. Whenever possible collect from same Niskin and same depths as DOC, Chl-a, and  $\delta^{18}\text{O}$ . Whenever optical properties (RF1) of the water column are measured CDOM samples should be collected from a cast back to back with optical profiles.

→ **Chemicals used:**

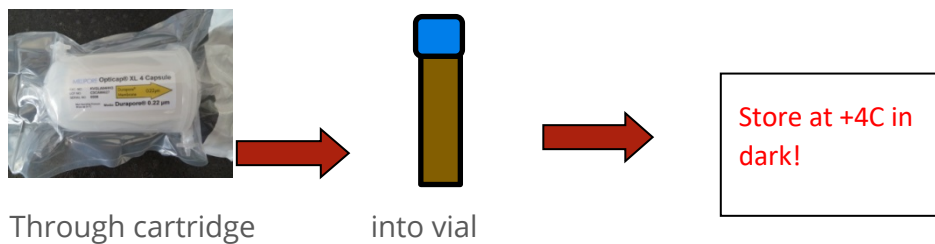
Materials:

- Amber EPA type glass vials with caps (20-40ml, burned and caps acid-washed)
- Filter capsule (Millipore Opticap XL4, Durapore 0.22  $\mu\text{m}$ , KVGLA04HH3) and (clean) tubing Laboratory gloves
- Labels

## Preparations:

**Before a new filter cartridge is used the first time it has to be rinsed with 4 L of Milli-Q water or clean seawater** (from great depth with little particles or DOM) with gravity to clean off any residuals on the membrane. Tubing used should also be acid soaked in weak acid and copiously rinsed before use.

## Collecting the samples:



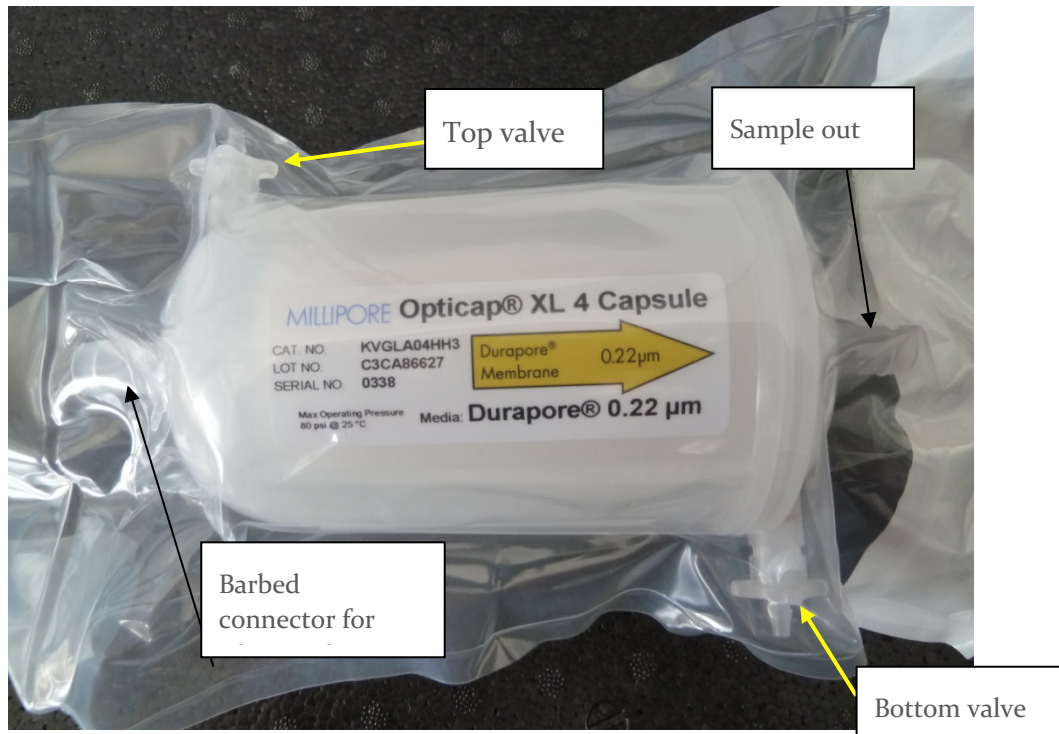
*Fig. 1 Schematic of the collection of CDOM sample.*

## Collecting the CDOM sample with cartridge:

- 1) **Always use laboratory gloves when collecting the samples** to minimize the contamination risk, as any fats, oils etc. on your hands contaminates the measurements. **Do not touch the insides of the vials and caps, or the tip of the nozzle on the Niskin bottle or the filter capsule inlet/outlet**, as these parts come in contact with sample water. **Avoid touching anything that is dirty, dirty gloves do not help!** *If you have dirty gloves, they do not do their job. Switch to a new pair.*
- 2) The same filter capsule can (normally) be used for hundreds of samples. **Always start with the deepest seawater sample** (as it normally is the “cleanest” one) and move towards the surface when collecting sample water from the rosette. It is always good to flush with extra seawater through the capsule before collecting the first sample at each station.
- 3) Attach the tubing to the Niskin nozzle (note that the capsule is correctly aligned, see Figure 2). Make sure the bottom valve is closed, and the top valve is open. Point the cartridge such that arrow points downwards to help water flow through the filter.

- 4) Open the Niskin nozzle and fill the capsule with seawater (i.e. until water runs out of the top valve).
- 5) Close the top valve and let about 200 ml seawater pass through by gravity.
- 6) Fill the CDOM amber vial to the shoulder. Leave some headspace in vial! Close cap firmly.
- 7) Close the Niskin nozzle. Remove tubing from Niskin. To empty the capsule before next sample open the bottom valve, turn it upside down (arrow pointing upwards), and let water drain out. Close the bottom valve.
- 8) Note down the sample ID in the CTD sheet after each sample has been collected to be sure of which Niskin bottle it was collected from!
- 9) Go to next Niskin bottle. Repeat steps 1 to 6 until you have collected all samples.
- 10) After station empty the filter cartridge of seawater (step 5), and rinse with 200-300 ml of Milli-Q.
- 11) Store filter capsule and the tubing in a plastic bag or container with Milli-Q between stations, to avoid it getting contaminated.
- 12)

→ **Sample storage / Shipment address** Store the CDOM samples at +4°C in dark (in refrigerator onboard). DO NOT FREEZE! Plan is to measure samples onboard, if that is not possible, the samples are to be shipped (in a well-insulated box) to Murat V. Ardelan, NTNU, Trondheim



*Fig. 2 Filter capsule in protective bag (note that the filter capsules might have somewhat different shapes depending on batch and year). Note that an arrow shows the direction water should flow through the filter (check it before using).*

### 8.7.1 Measurement of CDOM absorbance

**Measured parameter:** Colored (or chromophoric) dissolved organic matter (CDOM).

**Method responsible:** Murat V. Ardelan (RF2: NTNU, murat.v.ardelan@ntnu.no)

**Description of parameter:** Colored (or chromophoric) dissolved organic matter (CDOM) measurement with Liquid Waveguide Capillary Cells (LWCC) for ultra violet (UV) and visible (VIS) absorbance spectroscopy is done for ultra sensitive measurements of absorbance. Hence, several factors may affect the data analysis and external interferences must be kept at minimal.

### Methodological description:

- **Special requirements/gear:** Dry lab with stable temperature.
- **Sampling depths:** See 7.8 CDOM sampling protocol
- **Chemicals used:** Methanol (HPLC grade), 1N HCl (HPLC grade), high grade NaCl solution

### Materials:

- CDOM samples in vials
- 1N HCl (HPLC grade)
- Methanol (HPLC grade)
- Milli Q water or Ultra-pure water (UPW) (*For cleaning and washing purpose*)
- Reference UPW (*For analysis store in an amber coloured clean glass bottle*)
- High grade pure NaCl solution with salinity similar to water samples collected (\* salinity = 35)
- Ocean Optics Liquid Waveguide Capillary Cells (LWCC) absorbance spectrometer system with software uploaded PC
- Waterbath (*Room temperature*)
- Peristaltic pump

### Method:

- 1) Fix the LWCC system stably on to workbench and try to minimize movements.
- 2) Switch on the light source of LWCC at least one hour before the start of the measurement for constant temperature and stable measurements.
- 3) A water bath maintained at constant temperature must be used to stabilize the temperature of reference UPW and NaCl solution before running through LWCC system.

- 4) A constant flow rate of 1 ml / minute is maintained during the absorbance measurement. Always remember to fill in the capillary tube completely with the solution before each measurement.
- 5) Connect the spectrometer to the PC with software and observe the readings online.
- 6) Use reference UPW to measure the baseline of absorbance and to keep track if there is any shift in the baseline absorbance during the course of sample analysis. Repeat replicates until stable results are obtained. This procedure needs to be repeated as and when needed if the drift noted is high.
- 7) Next measure the NaCl solution at beginning and after samples from a station or during start and end measurements of a day. Repeat with replicates for stable values.
- 8) Run at least three times 10 ml each of UPW to clean the system after step 4.
- 9) The absorbance measurement is done from 300 nm to 750 nm. At least triplicates must be run for each sample. However, as the sensitivity is quite high it is recommended to get at least 15 to 20 spectra for each of the replicate measured.
- 10) After each analysis wash the system three times with 10ml UPW. After each sample wash with HCl (10 ml) and methanol (10 ml) followed by at least five times 10 ml UPW rinsing or until the spectra is stable.
- 11) Repeat step 3 to obtain baseline value.

Calculation of CDOM absorption:

Absorbance ( $A$ ) from spectra is converted into Napierian absorption coefficient [ $a$ ] in  $m^{-1}$ , using:

$$a = \frac{2.303 * A}{L}$$

where  $A$  is the absorbance at specific wavelength and  $L$  is the optical path length of the LWCC in meters.  $a$  is generally adopted as a proxy for assessing the CDOM content in a given water sample.

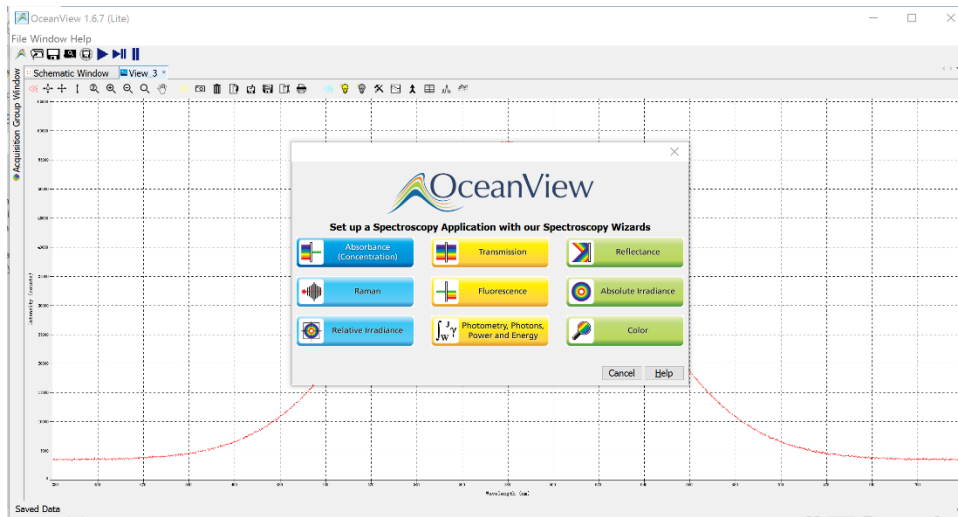
$$a_{CDOM} = (a_{sample} - a_{reference\ UPW}) - (a_{NaCl} - a_{reference\ UPW})$$

Where  $a_{CDOM}$ ,  $a_{sample}$ ,  $a_{reference\ UPW}$ ,  $a_{NaCl}$  where are absorption coefficients of CDOM, sample, reference UPW and NaCl solution respectively.

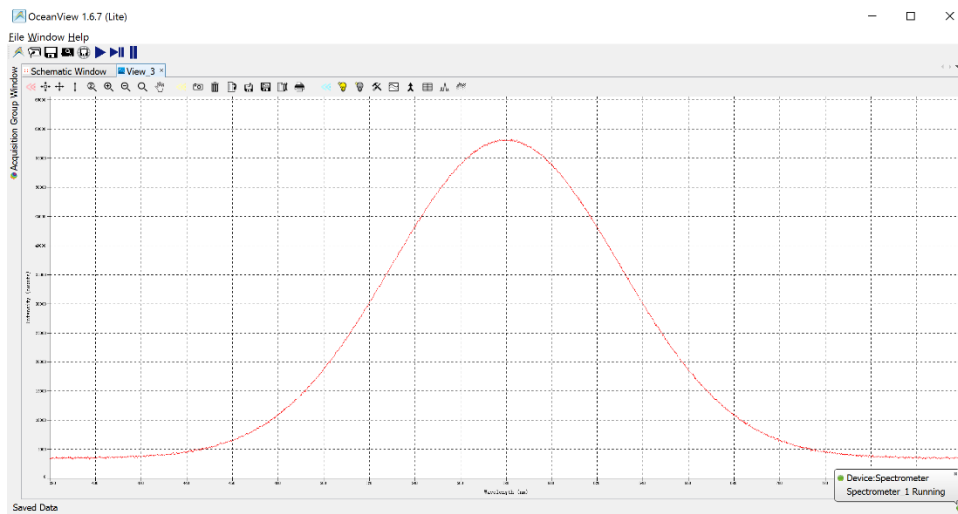


*Fig. 1 LWCC system with connections attached*

**Ocean View Software** (<https://oceanoptics.com/product/oceanview/>): This software gives helps for the measurement of the absorbance, fluorescence. The software also has help contents that are self-explanatory for making required modifications necessary for measurement of samples.



*Fig. 2 Ocean View software*



*Fig. 3 Background absorbance measurements*

## 8.8 PARTICULATE ELEMENT CONCENTRATION USING XRF

**Measured parameter:** Concentration of total particulate O, P, Na, Mg, Si, S, Ca, Mn, Fe, Zn ( $\mu\text{M}$ ) measured using X-Ray Fluorescence (XRF)

**Method responsible:** Jorun K. Egge (UiB, jorun.egge@uib.no), Tatiana Tsagaraki (UiB, tatiana.tsagaraki@uib.no)



## Description of parameter:

## Methodological description:

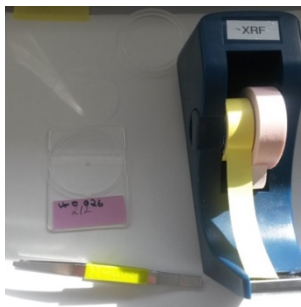
### → Special requirements/gear:

→ **Sampling depths:** Standard depths, all stations 10, 25, 50 75, 100 and 200m, DCM and deep sample (bottom -15m); **Sampling Volume:** Sampling Volume: For surface water 500ml should be sufficient. Below Chl max, increase volume to 1000ml if possible.

### → Chemicals used:

## Before filtration:

- 1) Collect water sample from rosette into a plastic container. The container should be clean and rinsed with distilled water before use.
- 2) If samples will stand for a while before filtration ideally they should be stored in a fridge or cool dark place.
- 3) Gently agitate container before filtration to resuspend any sedimented material
- 4) Prepare petri slides (pictured below): We usually mark a piece of tape with the sample code (a number) and tape it onto the petri slide. Each sample should have a cruise code and unique number (e.g. CRE001, CRE002 etc.).

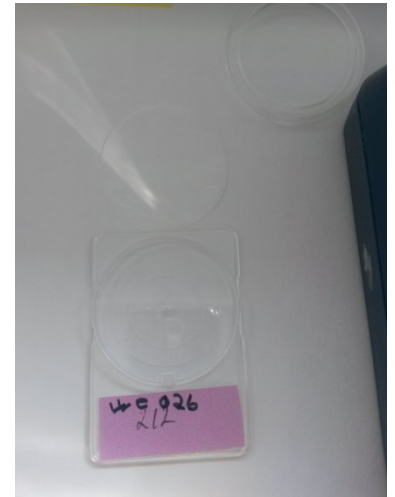


- 5) Blanks (two types are necessary):
- a. distilled water blank: Filter, dry and store 500ml of distilled water, in triplicate, following the protocol outlined in the next section  
NB: Distilled water blank only needs to be collected once per survey.
  - b. filter blank- Keep at least three unused filters from each box of filters used. Mark the box 1, 2 etc. and note on the info sheet which samples the blanks correspond to in the line filter box number (see example below).
- 6) When changing box make a note of info sheet of which sample number begins with a new box. We need to know which samples come from which box of filters for correcting the blank accordingly. Write down the filter batch number (see example of info sheet below):

Sample no	Station	Depth (m)	Date	Volume (ml)	Filter box number	Filter type	Comments
cre097	1	1500	10.05.	4	Box 1	0.6 PC	f.ex. starting new filter
cre098	1						blank box 2
cre099	1						blank box 2
cre100	2						blank box 2
cre101	2						Box 2 starts
cre102	2						

### For filtration:

- 1) Use 47mm 0.6 $\mu$ m (or selected pore size) polycarbonate filters in triplicate
- 2) Always note filtered volume on info sheet. It is OK to adjust volumes as needed, as long as the information is noted.
- 3) Before filtration gently agitate sample to resuspend particles
- 4) Filter selected volume using glass filtration funnels and collectors NB if there is a lot of material on the filter consider decreasing volume
- 5) When filtering is almost complete rinse filter with 5ml distilled water using pipette
- 6) Let filters air dry on sheet of paper or bench liner sheets.
- 7) Filters should be "weighed down" on one edge using labelled filter holder (see picture on the right)
- 8) Plastic box or other cover should be used to cover filters while drying,
- 9) Once filters are dry (for PC a couple of hours is more than enough), place in labelled filter holder and box



### Important tips:

- 1) Flat forceps should be used to avoid damaging filter
- 2) Filter must be as centered as possible on the funnel. If the material is towards the edge of the filter it may result in a blank area of the filter measured in the XRF
- 3) When rinsing filter, pour the distilled water down the sides of the funnel to avoid redistribution of the material. If you forget to rinse, make a note of it. Rinsing removes salt crystals from the filter, which interfere with the measurement of salts (obviously). Other elements are measured even if you forget to rinse.
- 4) There should not be any water left on the filter, dried drops create a lot of noise in the XRF
- 5) Filter should not be left empty under vacuum for too long, cells will break

6) Depending on the temperature, drying of PC filters can take ca 15 mins to two hours.

→ **Sample storage/ shipment address:** Samples must be stored at room temperature, in their box. Under no circumstances should the samples be refrigerated or frozen. Ship to operators address at end of cruise. No special requirements for shipping.

**Ship to:**

Institutt for biovitenskap, Biologen  
Thormøhlens gate 53A, 2. etg  
5006 BERGEN

## 8.9 INORGANIC NUTRIENTS

**Measured parameter:** Inorganic nutrients

**Method responsible:** Melissa Chierici (IMR, melissa.chierici@hi.no)

**Description of parameter:**

**Methodological description:**

→ **Special requirements/gear:**

→ **Sampling depths:**

→ **Chemicals used:** Chloroform: Trichloromethane

**Materials:**

- Sampling bottles: Vials PE 25 ml.
- Boxes: Cardboard box for storage of 100 pc of samples
- Dispenser: automatic pipette 0,2-1,0mL
- (remember adapter to 500mL chloroform bottle)

- Chloroform: Trichloromethane for spectrophotometry (Uvasol) Merck no: 2447.0500.
- NB! Chloroform shall be treated with caution!

Method:

- Use labelled sample vials and add the number on the CTD-Rosette sample list.
- Sampling: Rinse the bottles and cork with water from the appropriate Niskin flask at least 3 times before filling up. Fill the bottle, but leave a little room left for preservation. Use only new and clean scintillation bottles.

Preservation after sampling:

- 1) Preserve the samples with 200  $\mu$ L (0.2 mL) chloroform using an automatic pipette. Check that it is set on the correct volume. Test the pipette before preserving the samples to ensure that dosing takes place. Keep the equipment clean to avoid contamination!
- 2) Keep cool! Keep the preserved samples in the fridge in the dedicated cardboard boxes, label with cruise name/number, date.

**SHORT VERSION:**

1. Make sure the vials are numbered
2. Rinse vial and cap with water from the sampled Niskin 3 times before filling up leaving some headspace for preservation
3. Add 0,20mL (200 microliter) chloroform
4. Place the samples in fridge/cool storage in boxes

→ **Sample storage/ shipment address:** Samples have to be transported using cold freight and they should not be in room temperature or more for more than a few hours (1-3 hrs).

## 8.10 WATER COLUMN SAMPLING FOR ALGAL PIGMENT CONCENTRATIONS (CHLOROPHYLL *a*, PHAEOPIGMENTS)

**Measured parameter:** Algal pigment concentrations (Chlorophyll *a* and phaeopigments) from the water column

**Method responsible:** Rolf Gradinger (UiT, rolf.gradinger@uit.no), Anna Vader (UNIS, anna.vader@unis.no)

**Description of parameter:** Quantification of algal pigment concentration (chlorophyll *a*, phaeopigments; in  $\mu\text{g L}^{-1}$ ) using the fluorometric acidification method (see separate protocol for measurements).

**Methodological description:**

→ **Special requirements/gear:** Avoid any direct sun light or strong light exposure of samples during any part of the sampling process because algal pigments are sensitive to light. For example, use plastic sampling bottles wrapped in tin foil.

→ **Sampling depths:** Standard depths 5, 10, 25, 50, 75, 100 and DCM (deep chlorophyll fluorescence maximum; as detected by *in situ* fluorescence profile; only if present and significantly  $\pm 5\text{m}$  different from standard depths). One sample per depth as standard.

→ **Chemicals used:** Methanol

**Method:**

- 1) Lower CTD mounted fluorescence profiler to below 100m (or bottom depth if shallower) to determine the presence/absence of a DCM.
- 2) Collect seawater (250 ml to 2l, depending on expected pigment concentration) from the Niskin bottles from standard depths and potentially DCM down to 100 m. Rinse the plastic sampling bottle with sample water three times (~100 ml in total, depending on water budget) before collecting the sample.

- 3) Store plastic bottles in dark and cold location until time for filtration; filtration should occur within one hour (the faster the better).
- 4) Remember to gently mix the bottle (turn upside down for a couple of times) before filtering to ensure that no particles settle down (results in uneven concentration if subsampling the sampling bottle).
- 5) Be sure to have placed the non-combusted Whatman GF/F filter (typically 25mm, depending on filtration rig) in the middle of the filter holder and that the funnel is thoroughly placed on top of it (if something is leaking the exact volume filtered or the filtration area on the filter is not known – these are needed for the calculations later).
- 6) Filter ca. 50-2000 ml (depending on biomass – a light colour on the filter is enough) from each depth through 25 mm GF/F filters. Too much volume can result in clogging of the filter, too little volume can cause poor readings on the fluorometer.
- 7) Use low vacuum pressure (about -30 kPa). Always have the valve of the filtering funnel closed before turning the pump on or off.
- 8) Cover the funnels with tin foil while filtering. If you expect to filter 1 L or 2 L, you can place the plastic sampling bottle directly onto the funnel and let it run until empty. Ideally the 0.5 and 1 L mark should be indicated on the plastic sampling bottles prior to the sampling.
- 9) Rinse the funnel with GF/F filtered seawater (collect filtered sea water from previous filtrations into squeeze bottle) once the sample has been filtered. Do not let the filters dry out, close the valve.
- 10) Use forceps to fold the filter once and then place it into the plastic tube for Chl a extraction (10 ml Polypropylene (PP) tubes or reusable »Dramsglass« tubes with labelled plastic lids).
- 11) Label the PP tube with a cryomarker with sample ID. **NOTE: Sample ID rules for AeN TBD.**
- 12) Cover the sample labelling on the extraction tubes with transparent scotch tape because the solvent (methanol) will remove all markers.
- 13) Rinse the filtration equipment with MilliQ before the next sample. Cover filtration funnel with tin foil when not in use (to avoid dust).
- 14) Prepare samples in PP tubes for extraction with organic solvent if samples can be processed the next day (see separate document for details, preferred way).

15) If samples can't be measured the next day, samples in PP tubes should be shock-frozen in liquid nitrogen in a Dewar container (e.g. 2l) immediately after filtering and transferred to a -80°C freezer for storage once all samples from one station have been filtered. Wrap PP-tubes in tin foil prior to long term storage. Store all samples from one station within one Ziplock bag and label Ziplock bag with station ID, sample IDs and "Algal pigment samples."



*Fig. 1 Example of a filtration set-up.*

#### 8.10.1 Measurements of algal pigment concentrations (chl *a*, phaeopigments) based on samples from water column and sea ice

**Measured parameter:** Algal pigment concentrations (chl *a*, phaeopigments) from the water column and sea ice



**Method responsible:** Rolf Gradinger (UiT, rolf.gradinger@uit.no), Anna Vader (UNIS, anna.vader@unis.no)

**Description of parameter:** Quantification of algal pigment concentrations (chl a, phaeopigments) (in  $\mu\text{g L}^{-1}$ ) using the fluorometric acidification method.

### Methodological description

#### → Special requirements/gear:

- Approx. 1 m bench space for Turner Design AU10 fluorometer,
- potentially fume hood for organic solvent addition to Polypropylene (PP) tubes, waste containers for organic solvent and HCl mixture after measurements.
- Waste container for gloves.
- Nitrile lab gloves recommended (to avoid potential LATEX allergic reactions).

#### → Sampling depths:

#### → Chemicals used: Methanol, HCl

### Method:

- 1) **Work as dark as possible.** Fluorometer should be in the darkest possible space, potentially wearing a red head lamp.
- 2) Add 5 ml methanol to the PP tube containing the GF/F filter. Use a dispenser, put a lid on the tube and cover with tin foil or store in black box/bucket with or cardboard box.
- 3) Extract in the dark “over night” (12 hours minimum, 24 hour maximum) in a refrigerator between 0 and 4 deg C. NB: Note the start and end time of extraction period.
- 4) Turn on fluorometer (model AU 10) at least 10 min before taking the first measurement. For greater details regarding Turner fluorometers, you can check the company website recommendations for chlorophyll measurements.

- 5) Check that the fluorescence reading of the fluorometer is at Zero, using pure methanol.
- 6) Vortex the tube for a few seconds and **let the sample adjust to room temperature** before fluorometer reading.
- 7) Transfer the sample to a clean borosilicate cuvette, and dry the cuvette on the outside using lens paper.
- 8) Place the cuvette in the cuvette holder of the fluorometer and wait until readings have stabilized. Press \* button on fluorometer (see picture below), it will first show **Delay**, then **Average** and finally **Done** on the fluorometer display. Read the value on the fluorometer. This is the R<sub>b</sub> value (Reading **before** acid addition).
- 9) Take the cuvette out of the cuvette holder and add 2 drops of 5% HCl using Pasteur pipette, cover the cuvette with parafilm and mix it gently 3 times. Wait ca 90 seconds, then take a second fluorescence reading with the fluorometer. This is the R<sub>a</sub> value (Reading **after** acid addition).
- 10) Place all chemical waste in a labeled waste container bottle. Wash cuvette with clean methanol between each sample and let it dry (place upside down on tissue paper).
- 11) Remember: Before start, and in between (every 15 samples), use a methanol blank to check that cuvettes are clean and that the fluorometer blank reading is stable at zero for methanol.



*Fig. 1 Display and buttons of the Turner Design AU10 Fluorometer, \* button is indicated by the red arrow*

### Calculation of chlorophyll and phaeopigment concentrations:

For chlorophyll a - concentration C:

$$C = F_s (r/(r-1)) (R_b - R_a) V_{ex} / V_{sam}$$

where:

C = chlorophyll a concentration ( $\mu\text{g/L}$ ),

$F_s$  = response factor for the sensitivity setting S (see section calibration)

r = the before-to-after acidification ratio of a pure chlorophyll a solution (see section calibration),

$R_b$  = fluorescence of sample extract before acidification

$R_a$  = fluorescence of sample extract after acidification.

$V_{ex}$  = extraction volume (L, 0.005L suggested)

$V_{sam}$  = volume filtered sample (L)

**For phaeopigment - concentration P:**

$$P = F_s (r/(r-1)) (rR_a - R_b) V_{ex} / V_{sam}$$

For abbreviations, see chlorophyll a calculation above.

### 8.11 CONCENTRATING PROTISTS <10 µM BY VIVAFLOW FILTRATION

**Measured parameter:** Concentration of protist cells <10µm by vivaflow filtration

**Method responsible:** Bente Edvardsen (UiO, bente.edvardsen@ibv.uio.no),  
Luka Supraha (UiO, luka.supraha@ibv.uio.no )

**Definition of parameter:** Concentration of protist cells <10µm for electron microscopy and culturing by tangential filtration.

**Methodological description:**

- **Special requirements/gear:** Vivaflow Cartridge for plankton, Masterflex pump with adjustable speed
- **Sampling depths:** DCM if detectable, Melt ponds (Ice stations)
- **Chemicals used:** NaOH 1M, Ethanol

**Material:**

- Vivaflow Cartridge for plankton
- Masterflex pump with adjustable speed
- Bottle 3L for the sample
- Falcon tube 50ml
- Clamps with screw
- Containers for
- MiliQ water 1L
- NaOH 1M 500ml
- EtOH 10% 500ml
- FSW (0.2µm) 500ml

## Method:

1. Prepare the Vivaflow setup by placing the filtrate and retentate tubes into a waste tank and the feed tube into MQ water container.
2. Rinse the cartridge with 250ml of MQ water.
3. Fill a 3L water bottle with water sample prefiltered through ca 90  $\mu\text{m}$  mesh sieve.
4. Replace MQ water with sample and rinse the cartridge with 250ml of sample.
5. Put the retentate tube in the sample bottle. Increase the speed.
6. Concentrate the sample until about 250ml remains. For 3L of sample it will take about 30min.
7. Transfer 250 ml of the sample to a smaller bottle and then to 50ml Falcon tube.
8. Concentrate at lowest speed until the volume is reduced to 20ml.
9. Clamp the filtrate tube to recirculate the sample. No change in volume should take place.
10. Remove the feed tube from the sample to collect all the material in the Falcon tube.
11. Store the sample in a cool room for later use.
12. Place the retentate tube and the filtrate tube in the waste tank and the feed tube in the FSW container. Rinse with 250ml of FSW.
13. Rinse with 250 ml of MQ water.
14. Rinse with 50ml of 1M NaOH, then place all three tubes in the 1M NaOH container and recirculate for 20min
15. Rinse with 250ml of MQ water.
16. Turn off the pump and clamp all three tubes. For storage longer than one day store in 10% EtOH.

→ **Sample storage:** Concentrated samples should be kept in a cool and illuminated room at ca. 4°C.

## Literature:

- Daniel Vaultot Tangential flow filtration (TFF) concentration of phytoplankton. [protocols.iodx.doi.org/10.17504/protocols.io.krmcv46](https://doi.org/10.17504/protocols.io.krmcv46)
- Marie, D., Shi, X.L., Rigaut-Jalabert, F. & Vaultot, D. (2010). Use of flow cytometric sorting to better assess the diversity of small photosynthetic eukaryotes in the English Channel. *FEMS Microbiology Ecology*. 72. p.pp. 165-178.

## 8.12 LIGHT MICROSCOPY PHYTOPLANKTON/PROTISTS

**Measured parameter:** Phytoplankton/protist abundance (in cells L<sup>-1</sup>) using the Utermöhl method.

**Method responsible:** Rolf Gradinger (UiT, rolf.gradinger@uit.no), Philipp Assmy (NPI, philipp.assmy@npolar.no)

**Description of parameter:** Identification and quantification (abundance in cells L<sup>-1</sup>) of phytoplankton/protists with an inverted light microscope using the Utermöhl method.

**Methodological description:**

→ **Special requirements/gear:** Fume hood for addition of fixatives. Wear personal protection. Use waste containers as needed.

→ **Sampling depths:** Standard depths at process stations 5, 10, 30, 60, 90 and DCM (see algal pigment sampling for specific comments regarding DCM)

→ **Chemicals used:** hexamethylenetetramine-buffered formaldehyde and acidic Lugol's solutions.

**Material:**

- 200 mL brown glass bottles, one per sample
- hexamethylenetetramine-buffered formaldehyde and acidic Lugol's solutions (see separate protocol for preparation of fixatives).

**Method:**

- a) Label the bottles with sample ID.
- b) Wear gloves. Add 2 mL acidic Lugol's to empty 200 ml brown glass bottles (final concentration 1%).

c) Fill ca 180 ml of seawater from each depth directly from the Niskin bottles into 200 ml measuring cylinder and transfer into the 200 ml brown glass bottles (see picture below).

d) Mix by gently turning the bottle up-side down three times.

e) Under the fume hood add 20 ml of 20% hexamethylenetetramine-buffered formaldehyde (final concentration 2%).

f) Mix by gently turning the bottle up-side down three times.

→ **Samples storage/shipment address:** Store samples in fridge or cold room during the cruise. Ship to operators address at end of cruise. Make sure that bottles are safely packed for transport (hard-casing boxes with bubble-foil filling).



*Fig. 1 200 ml brown glass bottle (right hand side)*

#### Literature:

- Throndsen J (1995) Estimating cell numbers. In: GM Hallegraeff DM Anderson AD Cembella. Manual on Harmful Marine Microalgae. Paris: UNESCO. pp. 63-80.
- Utermöhl, H. (1958). Zur Vervollkommung der quantitativen Phytoplankton-Methodik. Mitt. Int. Ver. Theor. Angew. Limnol. 9, 1-38.

### 8.13 LIGHT MICROSCOPY LARGE PROTISTS/RARE TAXA

**Measured parameter:** Protist (>20  $\mu\text{m}$ ) and mesozooplankton abundance (in cells  $\text{L}^{-1}$ ) of larger protists and small mesozooplankton

**Method responsible:** Rolf Gradinger (UiT, rolf.gradinger@uit.no), Philipp Assmy (NPI, philipp.assmy@npolar.no), Bente Edvardsen (UiO, bente.edvardsen@ibv.uio.no), Luka Supraha (UiO, luka.supraha@ibv.uio.no )

**Description of parameter:** Identification and quantification (abundance in cells L<sup>-1</sup>) of larger protists (>20 µm) and small mesozooplankton (e.g. copepod nauplii and *Oithona*) with an inverted light microscope using the Utermöhl method and the enriched water samples. Please note that naked/delicate protists are not quantitatively retained by this method. Those taxa are counted in directly fixed non-enriched water samples.

**Methodological description:**

→ **Special requirements/gear:** Requires potentially an extra CTD cast due to the large volume needs. Fume hood for addition of fixatives. Wear personal protection for fixation and sample handling. Use waste containers.

→ **Sampling depths:** Standard depths: 5, 10, 30, 60, 90 and DCM and 200m (if available, depending on bottom depth)

→ **Chemical used:** hexamethylenetetramine-buffered formaldehyde

→ **NOTE:** Suggested as sampling activity at all process stations only due to large water and time demand for sampling.

- a) Three Niskin bottles (10 L each) are closed per depth and their entire contents drained into a large carboy via long silicon tubing. Note the volume in the carboy.
- b) The contents of the carboys are then gently filtered over 20 µm mesh via a handnet or a filtration tower if available (see picture below).
- c) Samples are washed off the mesh with GFF filtered seawater using a squeeze bottle and concentrated to approx. 90 ml (measure exact volume with 100 ml cylinder)
- d) Sample is filled into 100 ml brown glass bottle and 10 mL 20% hexamethylenetetramine-buffered formaldehyde (final concentration of 1%) added.



- e) Wear personal protection when adding fixative!
- f) Label all bottles with sample ID.
- g) Store the samples dark and cold, do not freeze!

→ **Samples storage/shipment address:** Store samples in fridge or cool room during the cruise. Make sure that bottles are safely packed for transport (hard-casing boxes with bubble-foil filling).



*Fig. 1 100 ml brown glass bottle (left hand side)*



*Fig. 2 Example of filtration tower (AWI-made; contact Uwe John) to concentrate large protists and small mesozooplankton (right side)*

#### Literature:

- Throndsen J (1995) Estimating cell numbers. In: GM Hallegraeff DM Anderson AD Cembella. Manual on Harmful Marine Microalgae. Paris: UNESCO. pp. 63-80.
- Utermöhl, H. (1958). Zur Vervollkommung der quantitativen Phytoplankton-Methodik. Mitt. Int. Ver. Theor. Angew. Limnol. 9, 1-38.

## 8.14 METABARCODING (DNA AND RNA) OF PROTISTS AND PROKARYOTES

**Measured parameter:** Metabarcoding (DNA and RNA) of protists and prokaryotes

**Method responsible:** Anna Vader (UNIS, [anna.vader@unis.no](mailto:anna.vader@unis.no)), Bente Edvardsen (UiO, [bente.edvardsen@ibv.uio.no](mailto:bente.edvardsen@ibv.uio.no)), Lise Øvreås (UiB, [lise.ovreas@uib.no](mailto:lise.ovreas@uib.no))

**Description of parameter:** Cells collected on filter, to be used for DNA and RNA isolation. Will result in OTU table of organisms.

**Methodological description:**

→ **Special requirements/gear:**

- Clean area for filtration/sample handling
- Fume hood for adding Glutaraldehyde and Lugol's
- Minus 80°C freezer and liquid nitrogen tank

→ **Sampling depths:** 5m, DCM, "deep" (=15 m above-bottom), 200m (at deep stations)

→ **Chemicals used:** Glutaraldehyde EM grade 25% Merck and Lugol's

Method:

***IMPORTANT:***

- Always use lab gloves (also when handling equipment, e.g. washing, storing).
- RNA degrades quickly due to hydrolysis and RNAses (which are everywhere!). Change gloves after touching surfaces, work quickly. Never leave RNA at room temperature.
- DNA is very stable. Cross-contamination of samples is thus an issue. Clean tweezers with ethanol before use. Change gloves between samples.

- Immediately after use, rinse all containers, tubes and filtration equipment with distilled water and leave to dry in clean area.
- Glutaraldehyde is very toxic and should be added in fume-hood. Also keep waste in fume hood.

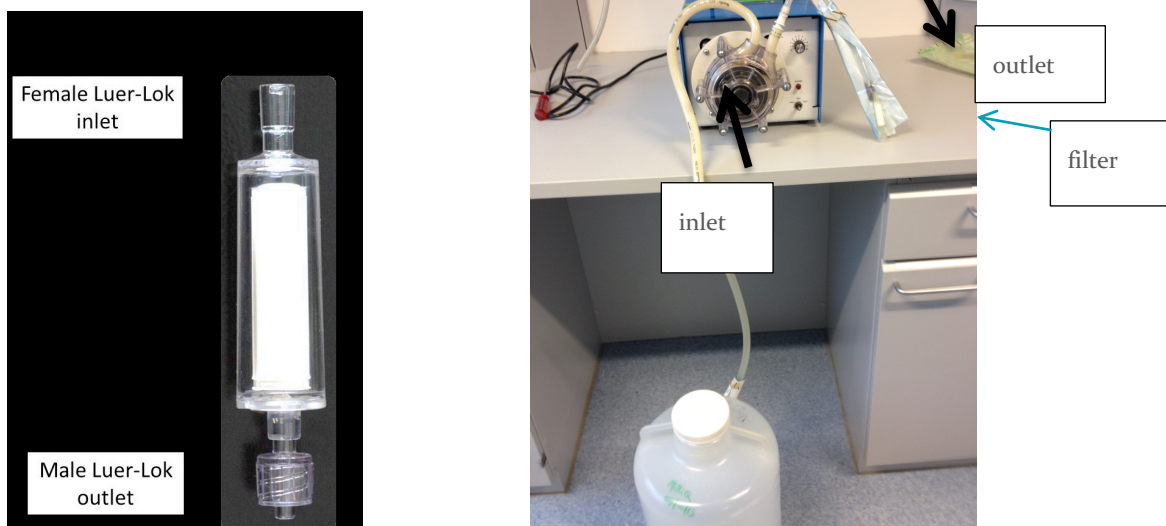
→ **NOTE: Filtration should be done in triplicate for each depth. In total 3x7L=21L of water should be filtered.**

- Prior to sampling: Label and number Sterivex filters, prepare pump (insert tubing). Number one 10L bucket for each Sterivex filter. Label sample-containers.
- Collect 22-25L of water from Niskins into 10 or 20L clean carboys (labelled with depth).
- Before connecting Sterivex filters, rinse the tubes by pumping appr. 1L of sample water through them.
- Connect the Sterivex filter unit to the Luer-Lok fittings on the tube (with a twist, see photos). The female Luer-lok side is the inlet. The filter can be hung over a bucket; there is no need for a tube connected to the outlet of the filter.
- Set the pump speed (flow rate 6 mL per sec) and the pump in forward position. Filter appr. **7 liters** of water through each Sterivex filter unit. Make sure the connections are tight and that there is no pressure build up (seen as considerable expansion of the tubing and leaks)!
- Disconnect the Sterivex filter unit from the tube and remove as much of the remaining water as possible using a 50 mL syringe containing air.
- Cap the filter in both ends with the inlet and outlet caps. Snap-freeze the filter in liquid N<sub>2</sub>. Transfer to -80°C freezer for storage.
- Measure the volume of filtered water from buckets, using measuring cylinders.
- Repeat procedure with next Sterivex filter.
- For each filter, note down time of sampling (UTC), filtration volume, filtration time, size fraction, any deviation from protocol, observation (e.g. color on filter) in log-sheet.
- After filtering all samples, clean the tube by pumping through approx. 1 liter of sterile distilled water.

Extra procedure during bloom conditions (only surface and DCM samples):

→ NOTE: this filtration is carried out to enrich for small cells that may be poorly represented due to clogging by larger cells. It should be done in addition to standard sampling.

- Pour water sample through pre-filtration funnel equipped with 20  $\mu\text{m}$  net.
- Collect cells (from 20  $\mu\text{m}$  flow-through) on labelled Sterivex filter using a peristaltic pump as above.
- Cut out the 20  $\mu\text{m}$  mesh from the funnel using a sterile scalpel and a tweezer washed in 70% EtOH, and transfer to 50 mL of sterile filtered seawater in a 50 mL Falcon tube. Shake tube gently to wash off organisms from mesh. Transfer 14 mL of sample to a 15mL Falcon tube and add 560  $\mu\text{L}$  25% glutaraldehyde (1% final), and 14 mL of sample to another 15mL Falcon tube and add 150  $\mu\text{L}$  Lugol's (1% final conc.). The remaining is kept alive (ca 4 °C in growth chamber or fridge) for microscopy and single cell PCR.



*Fig. 1 Filtering equipment overview, inlet and outlet*

### Material and labelling:

- *Amount of water needed:* 3 x 7000 mL (plus extra for rinsing, total 22-25L)
- *Sampling time:* appr. 1 hour per sample
- *Sample labelling:* Station, date, depth, volume
- *Parameters to be recorded:* Station, date, time of sampling (UTC), depth, size-fraction, volume, filtration time, protocol used (ID nr?), any deviations from protocol, filter colour, buffer added (volume and type), storage (i.e. LNG), operator, sample responsible

### *Sampling equipment (on "deck"):*

- Niskin bottles (rosette)
- Silicon tubes to attach to the Niskin bottles to empty them, one per Niskin bottle, length ca 60 cm x 12
- Clean 10 or 20L containers (for collecting sample)
- Sterile lab gloves (all sizes)
- Plastic funnels lined with 20 µm mesh (KC Denmark, for pre-filtration), labelled with **depth**

### *Filtration equipment (in lab):*

- Peristaltic pump (ideally one for each depth=3)
- Tubing with Luer-Lok fitting
- 0.2 µm Sterivex filters, SVGPL10RC
- Syringe (50 mL)
- Inlet and outlet caps for sterivex filters
- Zip-ties for tightening tube to Luer-Lok connection
- Sterile distilled water and sea water
- Sterile lab gloves (all sizes)
- Buckets (10 L) to collect flow-through
- Liquid Nitrogen (LNG) tank for snap-freezing
- Measuring cylinder (2 L)
- Labelling pens
- Sterile scalpels and tweezers

- 70% Ethanol in squeeze-bottle
- 25% Glutaraldehyde
- Lugol's solution (see protocol for microscopy fixatives)
- Micropipettes for Glutaraldehyde and Lugol's and pipette tips
- 50 mL and 15 mL Falcon tubes

→ **Samples storage/shipment address:** Store samples in minus 80°C freezer on ship (boxes labelled "metabarcoding/Anna Vader/UNIS"). Will be unloaded at UNIS by operator after each cruise (dry-shipper needed for transport).

### 8.15 METATRANSCRIPTOMICS (MRNA) OF PROTISTS AND PROKARYOTES

**Measured parameter:** Metatranscriptomics (mRNA) of protists and prokaryotes

**Method responsible:** Anna Vader (UNIS, [anna.vader@unis.no](mailto:anna.vader@unis.no))

**Description of parameter:** Cells collected on filter, to be used for mRNA isolation. Will result in catalogue of gene activities.

**Methodological description:**

→ **Special requirements/gear:**

- Should be sampled at local noon (to allow comparison between stations).
- Samples need to be processed immediately
- Clean lab area for filtration and sample handling
- Minus 80°C freezer and liquid nitrogen tank

→ **Sampling depths:** 5m, only process stations

→ **Chemicals used:**

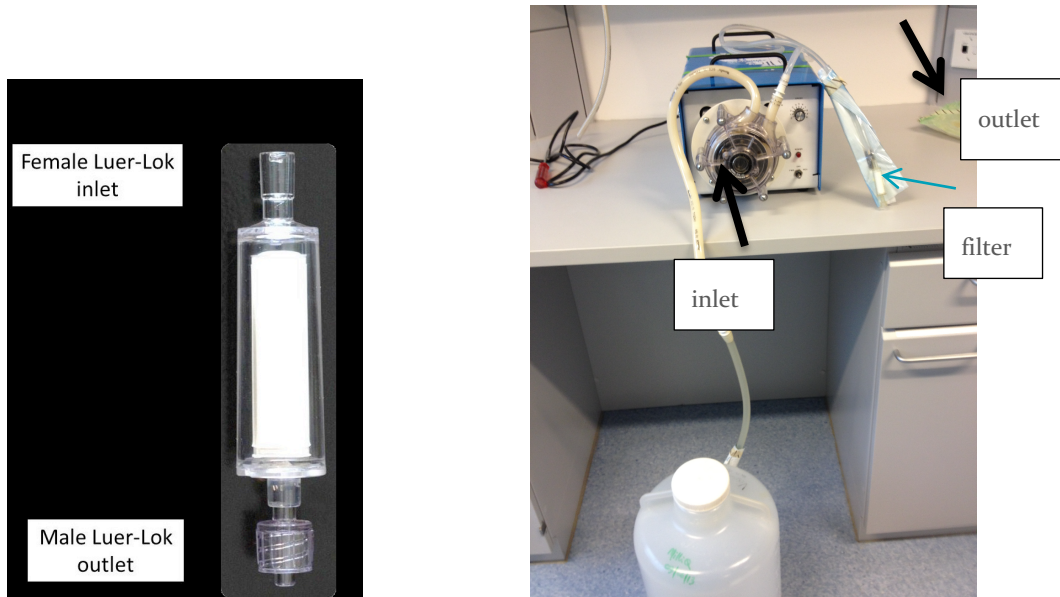
Method:

***Important:***

- Always use lab gloves (also when handling equipment, i.e. washing, storing).
- RNA degrades quickly due to hydrolysis and RNAses (which are everywhere!). Change gloves after touching surfaces, work quickly. Never leave RNA at room temperature.
- The mRNA composition changes according to the environment of the cell. Process samples immediately after collection, and try to keep sample at conditions resembling in vivo environment (i.e. light, temperature)
- Immediately after use, rinse all containers, tubes and filtration equipment with distilled water and leave to dry in clean area.

**NOTE that filtration should be done in triplicate, to process samples as quickly as possible.**

- In total  $3 \times 10\text{L} = 30\text{L}$  of water should be filtered.
- Prior to sampling: Label and number Sterivex filters, prepare pump (insert tubing). Number one 10L bucket for each Sterivex filter.
- Collect 35L of water from Niskins into 10 or 20L clean carboys.
- Before connecting Sterivex filters, rinse the tubes by pumping appr. 1L of sample water through each tube.
- Connect the Sterivex filter unit to the Luer-Lok fittings on the tubes (with a twist, see photos). The female Luer-lok side is the inlet. The filter can be hung over a bucket; there is no need for a tube connected to the outlet of the filter.
- Set the pump speed (flow rate 6 mL per sec) and the pump in forward position. Filter appr. **10 liters** of water through each Sterivex filter unit. Make sure the connections are tight and that there is no pressure build up (seen as considerable expansion of the tubing and leaks)!
- Disconnect the Sterivex filter unit from the tube and remove as much of the remaining water as possible using a 50 mL syringe containing air.



*Fig. 1 Filtering equipment overview, inlet and outlet*

- Cap the filter in both ends with the inlet and outlet caps. Snap-freeze the filter in liquid N<sub>2</sub>. Transfer to -80°C freezer for storage.
- Measure the volume of filtered water from buckets, using measuring cylinders.
- For each filter, note down time of sampling (UTC), filtration volume, filtration time, size fraction, any deviation from protocol, observation (e.g. colour on filter) in log-sheet.
- After filtering all samples, clean the tubes by pumping 69 approx. 1 liter of sterile distilled water through each tube.

→ **Extra information:**

- *Amount of water needed:* 30L (plus extra for rinsing tubes, total 35L)
- *Sampling time:* appr. 30 mins
- *Sample labelling:* Station, date, depth, volume
- *Parameters to be recorded:* Station, date, time of sampling (UTC), depth, size-fraction, volume, filtration time, protocol used (ID nr?), any



deviations from protocol, filter colour, buffer added (volume and type), storage (i.e. LNG), operator, sample responsible

- *Sampling equipment (on “deck”):*
  - Niskin bottles (rosette)
  - Silicon tubes to attach to the Niskin bottles to empty them, one per Niskin bottle, length ca 60 cm x 12
  - Sterile lab gloves (all sizes)
  - Clean 10 or 20L containers (for collecting sample)

*Filtration equipment (in lab):*

- Peristaltic pump with 3-4 pump-heads
- Tubing with Luer-Lok fitting
- 0.2 µm Sterivex filters, SVGPL10RC
- Syringe (50 mL)
- Inlet and outlet caps for sterivex filters
- Sterile distilled water
- Sterile lab gloves (all sizes)
- Buckets (10 L) to collect flow-through
- Liquid Nitrogen (LNG) tank for snap-freezing
- Measuring cylinder (2 L)
- Labelling pens
- Zip-ties for tightening tube to Luer-Lok connection
- Squeeze bottle with EtOH for cleaning
- Measuring cylinder (2L)
- Labelling pens

→ **Samples storage/shipment address:** Store samples in minus 80oC freezer on ship (boxes labelled “metatranscriptome/Anna Vader/UNIS”). Will be unloaded at UNIS by operator after each cruise (dry-shipper needed for transport).

## 8.16 FLOW CYTOMETRY SAMPLING

**Measured parameter:** Bacteria, virus and small protists abundance

**Method responsible:** Aud Larsen (Uni Research/Norce, aula@norceresearch.no) / Gunnar Bratbak (UIB, Gunnar.Bratbak.uib.no).

**Description of parameter:** Samples for enumeration of bacteria, virus and small protists (primarily  $<10\mu\text{m}$ ) by flow cytometry.

**Methodological description:**

- **Special requirements/gear:** Liquid nitrogen for flash freezing and -80 freezer for storing of samples. Fume hood for use of fixatives.
- **Sampling depths:** Standard depths at process stations 5, 10, 25, 50 75, 100 and 200m, DCM and deep sample (bottom -15m)
- **Chemicals used:** 25% glutaraldehyde (EM grade)

**Method:**

- When preparing for station: Label each cryovial (2mL) with running number using cryomarker and/or use pre-printed label – NB: If using label make sure the label sticks after snap-frozen in liquid nitrogen.
- Under the fume hood, add 38  $\mu\text{l}$  of 25% glutaraldehyde (EM grade) to each cryovial.
- Add sample directly from Niskin bottle into 20 ml scintillation vial (same as used for nutrients).
- Under the fume hood, pipette 1.8 ml of sample into 2 ml cryovial (3 vials per depth).
- Fix the samples for 2 h in a fridge.
- Snap freeze in liquid nitrogen.
- Store in cryobox at  $-80^{\circ}\text{C}$ .



→ **Samples storage/shipment address:** Store samples in -80°C during the cruise. Ship samples on dry ice using:

World Courier (Norway) AS  
Industrivegen 20  
2069 Jessheim (Oslo)

Tel: 47 6394 6200; Fax: 47 6394 6201; Email: ops@worldcourier.no

**OBS:** Make appointment for pick up well in advance of docking at the end of the cruise and coordinate with shipping of other frozen samples (e.g. Sterivex filters)

**Ship to:**

Institutt for biovitenskap, Biologen  
Thormøhlens gate 53A, 2. etg  
5006 BERGEN

## 8.17 BACTERIAL BIOMASS PRODUCTION

**Measured parameter:** Bacterial production of carbon biomass (gC per volume per unit time)

**Method responsible:** Gunnar Bratbak (UIB, Gunnar.Bratbak.uib.no)

**Description of parameter:** Bacterial production of carbon biomass (gC per volume per unit time) estimated from incorporation of tritiated leucine ([2,3,4-<sup>3</sup>H] leucine).

**Methodological description:**

→ **Special requirements/gear:** Isotope lab or area approved for use of <sup>3</sup>H. Incubator if not *in situ* incubation. Operator must hold a radioisotope safety course certificate.

→ **Sampling depths:** Standard depths at process stations 5, 10, 25, 50, 75, 100 and 200m, DCM and deep sample (bottom -15m)

→ **Chemicals used:** tritiated leucine, 100% TCA

#### Method:

- Use sterile 2 mL Eppendorf tubes labelled on top, 4 per sample (3 parallels + 1 blank)
- Dilute the isotope 1:10 in sterile saline (eye drops (physiological salt-water) ampules are convenient). Add xx  $\mu\text{L}$  isotope to each tube to give a final concentration of 50 $\mu\text{M}$  leucine.
- Start timer. For each sample (depth) add 1.5 mL water to 4 tubes and then 80 $\mu\text{L}$  100% TCA to the blank. Close the tubes. Start each new sample with 30 sec intervals to keep track of the incubation time.
- Incubate in situ or at in situ temperature for xx hours.
- Add 80 $\mu\text{L}$  100% TCA to all samples (except blanks) following the same sequence as used for starting the incubations.
- Label and secure tubes in the racks. Store the samples in the fridge and ship home for workup and scintillation counting as described in standard protocols.
- Clean the working area and perform wipe test.

→ **Samples storage/shipment address:** Store samples in fridge during the cruise. Ship to operators address at end of cruise following protocols for shipment of radioactive material.

#### Literature:

- Simon M and Azam F (1989). Protein content and protein synthesis rates of planktonic marine bacteria. *Mar. Ecol. Prog. Ser.* 51: 201-213.
- Smith DC and Azam F (1992). A simple, economical method for measuring bacterial protein synthesis in seawater using  $^3\text{H}$ -leucine. *Mar. Microb. Food Webs* 6: 107-114.
- Kirchman DL (1993). Leucine incorporation as a measure of biomass production by heterotrophic bacteria. In: *Current Methods in Aquatic Microbial Ecology* (P. Kemp, BE Sherr, EB Sherr and JJ Cole, Eds). Lewis Publishers, Boca Raton, FL.
- Kirchman D (2001) Measuring bacterial biomass production and growth rates from leucine incorporation in natural aquatic environments. *Methods in Microbiology*. 30: 227-237

## 8.18 IRON CHLORIDE PRECIPITATION OF VIRUSES FROM SEAWATER

**Measured parameter:** Recover viruses from natural waters.

**Method responsible:** Ruth-Anne Sandaa (UiB, ruth.sandaa@uib.no)

**Description of parameter:** Recover viruses from natural waters via iron chloride precipitation.

**Methodological description:**

→ **Special requirements/gear:** -80 freezer for storing of samples.

→ **Sampling depths:**

- WATER: Chl a max (or 20m if not detectable) and deepest sample at process stations. At deep stations (> 1000 m) add one sample at 500 m. 2 parallel samples of 20L pr event.
- SEA ICE: Bottom 10 cm of 2-4 ice cores.

→ **Chemicals used:** FeCl<sub>3</sub>, 0,1M EDTA-0,2M Ascorbate buffer (see recipe below)

- 0.966 g FeCl<sub>3</sub> x 6H<sub>2</sub>O in 50 mL falcon tubes (20 mL MQ gives 10g/L Fe Stock Solution)
- 10g NaOH (50ml MQ gives 5N NaOH)
- 1.51g Tris-base
- 3.72g Na<sub>2</sub>-EDTA dihydrate
- 4.07g MgCl<sub>2</sub>.
- 3.52g of ascorbic acid
- HCL 5N
- pH paper

**Buffer preparation:** 0,1M EDTA-0,2M Ascorbate buffer, pH 6.0-6.5 – 100ml

- Dissolve 1.51g Tris-base in 80ml Milli Q water.
- Dissolve 3.72g Na<sub>2</sub>-EDTA dihydrate into solution. (For info: pH will be ~10.0)

- Once EDTA is in solution, dissolve 4.07g MgCl<sub>2</sub>. (For info: pH will drop to ~8.0)
- Add 3ml of 5N NaOH. (For info: This will drop the pH to ~4.5 and the solution will become cloudy which indicates that the EDTA is coming out of solution.)
- Dissolve the reductant (3.52g of ascorbic acid or 2.52g of oxalic acid). (For info: The pH will increase to ~8.3 and the solution will clear up.)
- Once the reductant is in solution, add the last 1ml of 5N NaOH.
- Check the pH using pH paper (the buffer should be at pH 6.0 - 6.5). The solution may need some minor adjusting with NaOH or HCl to achieve a pH of 6.0. pH 6.0 is ideal for good recovery of viruses.
- Check the volume and add MilliQ water for a total volume of 100ml.
- Store the buffer in the dark (bottle wrapped in foil) and visually inspect prior to use. It should be clear without precipitates. At this point, 10-15ml of buffer can be sacrificed for a final pH check using a pH meter (if available).

The buffer will start to change colour after about 24 hours. It is okay to use if slightly discoloured, but do not use after about 36 hours (eventually the buffer will turn almost orange!).

Method:

#### WATER SAMPLES

- Prepare pump and Tripod by mounting the tubing to the pump head (see Figure and Tripod assembly diagram, Fig. 7.20-1). Set occlusion adjustment to 3 and the pump in direction of the Tripod (see Figure). When filtering, start the pump at low speed and increase to pump speed to 10 (will give a flow rate of ca 400 mL per min) when air has been removed and the vet valve closed.

- Filter 20 L of sample through 0.45  $\mu\text{m}$ , 142mm Durapore filters into clean 20 L containers. This is the water (filtrate) to be used for virus concentration, discard the filter.
- Prepare  $\text{FeCl}_3$  stock solution (10g/L) by adding 20 mL MQ water to pre-weight 0.966 g  $\text{FeCl}_3 \times 6\text{H}_2\text{O}$  in 50 mL falcon tubes.
- Add 1 mL of the  $\text{FeCl}_3$  stock solution to each 20 L of sample. Shake vigorously for 1 min (roll the containers back and forth on the floor).
- Add additional 1 mL of the  $\text{FeCl}_3$  stock solution to each 20 L of sample. Shake vigorously for 1 min (roll the containers back and forth on the floor).
- Let the  $\text{FeCl}_3$  treated water sit for 1h at room temperature to precipitate.
- Filter the  $\text{FeCl}_3$  treated water using 1.0  $\mu\text{m}$ , 142 mm polycarbonate (PC) membrane on top of a 0,8  $\mu\text{m}$ , 142 mm Supor Membrane filter (support). Change the PC filter 1-3 times during filtration if necessary (slow filtration rate, depending on biomass).
- Place all PC filters from the same 20L sample in one 50 mL Falcon tube, with the precipitate facing out. Discard the Supor filter.
- Prepare fresh 0,1M EDTA-0,2M Ascorbate buffer, pH 6.0-6.5 (See buffer recipe below)
- Add 20mL of 1x buffer to each of the Falcon tubes (precipitate from 20L seawater)
- Place tubes on a rotor o/n at 4°C.
- Transfer the liquid to two 15 mL marked Falcon tubes and store in cryobox at -80°C.

#### ICE CORE SAMPLES

- Melt the ice, filter through 0.45  $\mu\text{m}$  Durapore filters, measure the volume filtered and add the appropriate amount of  $\text{FeCl}_3$  stock solution (100 $\mu\text{L}$ /L) in c) and d), proceed as above.

→ **Samples storage/shipment address:** Store samples in -80 during the cruise and on dry ice during transport.

**NOTE: Make appointment for pick up well in advance of docking at the end of the cruise and coordinate with shipping of other frozen samples (e.g. Sterivex filters)**

Ship samples on dry ice using  
World Courier (Norway) AS  
Industrivegen 20  
2069 Jessheim (Oslo)  
Tel: 47 6394 6200; Fax: 47 6394 6201;  
Email: ops@worldcourier.no

Ship to:  
Institutt for biovitenskap, Biologen  
Thormøhlens gate 53A, 2. etg  
5006 BERGEN



**Literature:**

- John, S, Poulos, B and Schirmer C. 2015, Ion Chloride Precipitation of viruses from seawater, Protocols.io
- <https://www.protocols.io/view/Iron-Chloride-Precipitation-of-Viruses-from-Seawat-c2wyfd>

### 8.19 VIRAL PRODUCTION AND DECAY (REV.1)

**Measured parameter:** Viral production and decay

**Method responsible:** Ruth-Anne Sandaa (UiB, ruth.sandaa@uib.no)

**Description of parameter:** Measure rate for viral production and degradation

**Methodological description:**

→ **Special requirements/gear:** -80C freezer for storing of samples.

→ **Sampling depths:** Chl a max (or 20m if not detectable) and deepest sample at process stations

→ **Chemicals used:** 0.5 M NaOH, Ethanol



## Method:

Prepare two Vivaflow 200 cassettes, one 0.2  $\mu\text{m}$  PES and one 100 000 MWCO PES, and flush the systems with 500 mL MQ water as described (see *Vivaflow Assembly and operation, Fig. 21-1*). After use wash cartridges according to producer manual and store 10 % EtOH (4°C) (see *Cleaning and storage of Vivaflow* below)

### *Concentration of prokaryote and prokaryote free water (0.2 $\mu\text{m}$ cartridge)*

- Flush the Vivaflow 0.2  $\mu\text{m}$  PES cartridge with 50 ml of a 500 mL sample
- Start concentrating the sample while collecting the prokaryote-free filtrate.
- At approx. 50 mL, turn off the pump and transfer the sample to a 50 mL Falcon tube before continuing concentration to approx. 20 mL.

### *Virus-free water (100 000 MWCO cartridge)*

- Flush the Vivaflow 100 000 MWCO PES cartridge with 50 ml of a 200 mL aliquot of the prokaryote-free filtrate.
- Collect 150 mL of virus free filtrate

### *Virus production*

- Dilute the prokaryote concentrate to 150 mL with virus-free filtrate
- Distribute ca 50 mL to each of three Falcon tubes
- Incubate at *in situ* temperature in the dark.
- Collect, fix and store 1.8 mL samples for viral and bacterial counts according to the FCM protocol at time zero and after approx. 3, 12, 24 and 48 h of incubation (make notes of exact incubation time).

### *Viral decay*

1. Distribute 50 mL of the prokaryote-free water to each of three Falcon tubes
2. Incubate at *in situ* temperature in the dark.
3. Collect, fix and store 1.8 mL samples for viral and bacterial counts according to the FCM protocol at time zero and after approx. 3, 12, 24 and 48 h of incubation (make notes of exact incubation time).

→ **Samples storage/shipment address:**

Store samples in -80C during the cruise. Ship samples on dry ice using

World Courier (Norway) AS  
Industrivegen 20  
2069 Jessheim (Oslo)

Tel: 47 6394 6200; Fax: 47 6394 6201; Email: ops@worldcourier.no

**NOTE: Make appointment for pick up well in advance of docking at the end of the cruise and coordinate with shipping of other frozen samples (e.g. Sterivex filters)**

**Ship to:**

Institutt for biovitenskap, Biologen  
Thormøhlens gate 53A, 2. etg  
5006 BERGEN

**Literature:**

- Weinbauer, Rowe, Wilhelm, 2010, Determining rates of virus production in aquatic systems by the virus reduction approach., MAVE, chapter 1 pp 1-8
- Matteson, A.R., Budinoff, C.R., Campbell, C.E., Buchan, A., Wilhelm, S.W. Estimating Virus Production Rates in Aquatic Systems. J. Vis. Exp. (43), e2196, DOI : 10.3791/2196 (2010).URL: <http://www.jove.com/video/2196/>

## 8.20 COCCOLITHOPHORES AND OTHER SMALL PLANKTON FOR SEM

**Measured parameter:** Qualitative and quantitative analysis of coccolithophores and other small plankton

**Method responsible:** Luka Supraha (UiO, luka.supraha@ibv.uio.no ), Bente Edvardsen (UiO, bente.edvardsen@ibv.uio.no)

**Description of parameter:** Qualitative and quantitative analysis of coccolithophores and other small plankton

### Methodological description:

→ **Special requirements/gear:** Vacuum filtration system for 25mm filters with a peristaltic pump.

→ **Sampling depths:** Standard depths as for quantitative phytoplankton samples (including 5 m, DCM, 50, 100 m).

→ **Chemicals used:** none

### Material:

- Polycarbonate filters (25mm, pore size 0.8  $\mu\text{m}$ )
- Cellulose nitrate membrane filters (25mm, pore size 3  $\mu\text{m}$ )
- Vacuum filtration setup for 25 mm filters
- Tweezers, x2
- Gloves
- Plastic pipette, 2 mL
- Measuring cylinder (1L)
- Plastic bottle (1L)
- Millipore dishes (50 mm) for storing filters
- Waterproof marker
- Buffered freshwater (pH >7.4, buffered with ammonium) and filtered seawater (FSW)

### Method:

- Use clean and dry equipment. Wear gloves.
- Mount the filtration unit. Add 2 mL buffered freshwater on top of the scint and turn on the vacuum pump shortly. Place the cellulose nitrate membrane on the scint, and then the polycarbonate filter on top of it. Filters should be well aligned and without wrinkles.
- Collect >1 liter of sample from the Niskin bottles in a plastic bottle. Mix the bottle gently (do not shake it) to ensure even distribution of material.

- Fill a cylinder with the desired volume, 250 mL -1 L, depending on cell density. The material should be visible, but not be as a thick layer on the filter.
- Pour the water into the filtration funnel. Turn on the pump. The flow should be steady and not too fast, and it is better to use weak vacuum. Write down the volume filtered per sample.
- When the filtration is done, remove the funnel and let the vacuum on, until no liquid is visible.
- Carefully transfer the upper polycarbonate filter to a labeled Millipore filter dish (sample side up) and discard the cellulose nitrate membrane. The filters should be dried in an incubator or oven set to ventilation program at 50°C for ca 2 h. The filter dishes with filters should be partially covered with a lid while in the incubator.
- Rinse all the equipment with freshwater and wipe off the tweezers between samples.

→ **Samples storage/shipment address:** Once dried, the filters should be stored in closed Millipore dishes. During transport and storage, it is important to keep the filters with the sample side up. The samples are brought to the University of Oslo, Department of Biosciences.

**Literature:**

- Bollmann J, Cortes MY, Haidar AT, Brabec B, Close A, Hofmann R, et al. Techniques for quantitative analyses of calcareous marine phytoplankton. *Mar Micropaleontol.* 2002;44(3-4):163-85.
- Šupraha L, Ljubešić Z, Mihanović H, Henderiks J. Coccolithophore life-cycle dynamics in a coastal Mediterranean ecosystem: Seasonality and species-specific patterns. *J Plankton Res.* 2016;38(5).

## 8.21 MICROALGAL DIVERSITY BY CULTURING (SERIAL DILUTIONS)

**Measured parameter:** Microbial diversity

**Method responsible:** Bente Edvardsen (UiO, bente.edvardsen@ibv.uio.no),  
Luka Supraha (UiO, luka.supraha@ibv.uio.no)

**Description of parameter:** Isolation of microalgal cultures by serial dilutions

### Methodological description:

→ **Special requirements/gear:** Cold room or cold plate, culture chamber or culture room

→ **Sampling depth(s):** Seawater samples from all sampling stations from 5 m and DCM depths, and diluted vertical net hauls.

→ **Chemicals used:** no other than algal medium (below).

### Material:

- Multiwell cell culturing plates (96 wells, TPP), or 15 mL culturing glass tubes with screw lid. Each plate can be used for four samples.
- Suitable algal medium (e.g. IMR ½, L1, K or ES, 30 PSU) with salinity similar to the sea water sample. For isolation of species that thrive in oligotrophic waters the strength of the medium can, to start with, be reduced to 1/2-1/10 of the full medium. Dilute, if possible, the medium with sterile sea water from the actual locality.
- Automatic pipettes -1000 µL and -100 µL with tips
- Fresh seawater sample (or net haul sample for larger, abundant cells) or raw culture

### Method:

- Distribute 270 µL algal medium to each well with the automatic pipette. Keep the plate at the same temperature as the water sample, e.g. by placing the plate in the fridge before use or on a cooling element. Mark a cross on the lid of the plate between column 6 and 7 and between row D and H, and the sample ID in each of the 4 squares.
- Add 30 µL of algal sample to the first well in a row (column A).
- Mix carefully the diluted sample in the first well in the row by pipetting up and down slowly with the 1 mL pipette. Transfer 30 µL from well A1 to A2. Mix, transfer 30 µL from well A2 to well A3 etc., all the way to well A6. Do the same with rows B-D with the same sample. Do the same with three other samples in the other squares of the plate.
- Mark the plate with sample ID and date.

- Put the plate in a clear plastic bag to avoid evaporation and leave it in an incubator with white fluorescent light (ca 30-50  $\mu\text{mol photons m}^{-2} \text{s}^{-1}$ ) at suitable temperature (ca 4°C) for 2-4 weeks.
- Check the plates under a stereo microscope. From the wells with apparently uniform cultures a droplet is examined under the microscope at higher magnifications. If the culture is monoalgal and of interest, transfer it to a tube with algal medium.

→ **Samples storage/shipment address:** Multiwell plates containing serial dilutions should be kept in a culture room or an incubator with light/dark cycle at low temperature (4°C). During transportation put on a fitting lid and place in a cooling box with cooling elements and fill up with packing material to avoid tilting. Monoalgal cultures can be deposited and maintained at the Norwegian culture collection of algae (NORCCA) at UiO.

**Literature:**

- Andersen, R.A. & Kawachi, M. 2005. Traditional microalgae isolation techniques. In: Andersen, R. A. (ed). *Algal Culturing Techniques*. Elsevier Academic Press, 578 p.

## 8.22 DETERMINATION OF *IN SITU* PRIMARY PRODUCTIVITY RATE \ USING THE <sup>14</sup>C METHOD

**Measured parameter:** *In situ* primary production rate

**Method responsible:** Rolf Gradinger (UiT, rolf.gradinger@uit.no), Philipp Assmy (NPI, philipp.assmy@npolar.no)

**Description of parameter:** Determination of the production rate of organic material by phytoplankton under *in situ* conditions by using the <sup>14</sup>C method.

**Methodological description:**

→ **Special requirements/gear:** radioisotope container, permission to work with radioactive isotopes, *in situ* incubations through ice or deployed drifting buoys

→ **Sampling depth(s):** 5, 10, 20, 30, 40, 60, 90 m

→ **Chemicals used:**  $^{14}\text{C}$ -sodium bicarbonate working solution (e.g. 20  $\mu\text{Ci/ml}$ ), Hydrochloric acid (HCl 6M and 1M), NaOH (6N), Ethanolamine, Scintillation cocktail Ecotone

Material:

- Incubation bottles 250ml Polycarbonate
- Rope, buoy, carabiners
- GF/F filters
- Vacuum filtration manifold with waste bottles and vacuum pump and tubing
- Tweezers (2-3)
- Excator with fuming HCl (37%)
- Micropipets and tips (One of each: 1000  $\mu\text{l}$ , 200  $\mu\text{l}$  and 20  $\mu\text{l}$ )
- Cylinder (100 ml)
- Rinsing bottles (3x)
- Scintillation vials
- boxes to store scintillation vials for further processing back on land
- Trays for radioactive work
- Gloves (nitril size dependend on operator)
- Paper towels
- Radioactive waste containers (solid, liquid)
- Absorbing bench paper
- Light sensor on CTD
- Go Flow bottles or Niskin bottles on CTD
- 2 glass duran bottles 0.5L
- $^{14}\text{C}$ -sodium bicarbonate working solution (e.g. 20  $\mu\text{Ci/ml}$ )
- Hydrochloric acid (HCl 6M and 1M)
- NaOH (6N)
- Ethanolamine
- Nitrification inhibitor

**Assumption:** DIC determined by other group, otherwise additional sampling needed.

→ **NOTE:** Always wear safety goggles, a lab coat and gloves when working with  $^{14}\text{C}$  and any hazmat (e.g. scintillation cocktail). Collect all chemical/radioactive waste in clearly labeled waste containers. Keep a clear protocol on how  $^{14}\text{C}$  has been used.

Method:

1) Preparation of incubation bottles/flasks

Use the provided 250ml culture tissue flasks. Rinse flasks between measurements with 10% HCl, followed by distilled water. Dry before re-use.

2) Taking of water samples/ice sample:

Water samples are taken at the same depth as sediment traps are deployed (5, 10, 20, 30, 40, 60, 90 m). This should be matched by Chl *a* and POC data from the same depths. The selection of depth should cover the approximate light levels from >90 to ca 1% or less of surface PAR). PAR in the water should be determined during a CTD cast. If a Chl *a* maximum exists, one of the samples should be taken in the Chl *a* max. If melt ponds exist on the ice, take one set of samples from the melt pond.

For water sample from ocean or for melt pond sample: Take one light and one dark bottle from each sampling depth. Rinse bottles three times before filling. Keep the samples as shaded/dark as possible during treatments.

Three depths representing ideally different water masses are selected for determine the DIC uptake based on nitrification. For these depths a second dark incubation bottle is prepared as described above and 1ml saturated nitrification inhibitor is added.

From one depth two dark 250ml bottles are spiked with 0.1  $\mu\text{Ci/ml}$   $^{14}\text{C}$ -DIC. In one bottle nitrification is inhibited with a nitrification inhibitor for the



determination of DIC uptake due to nitrification. These samples are treated as the *in situ* nitrification bottles (see paragraph above).

For ice sample: take one complete ice core. Cut off and use only the bottom 1cm. Crush the ice (likely it will be in small pieces anyway if skeletal layer present). Place the sample into a clean 500ml Duran bottle. Add 400ml filtered sea water at 0-2degC from the surface. Shake distribute the ice evenly and wait until it is melted. Use the melted sample as a water sample. Important: Note the final volume of the melted water sample to calculate the volume of the added ice sample. Take a subsample for Chl *a* and POC.

Bring the samples in a dark container into the isotope lab for spiking.

Note: make sure that for each sampling depth/melt pond/sea ice samples, also samples are processed for Chl *a*, POC. Adjustment of sampling depths might be needed to match sampling by other groups. More important to cover the above given light profile range for the water column samples than precise depths.

### 3) Spiking with $\text{NaH}^{14}\text{CO}_3$ solution:

Achieve a final concentration of  $0.1\mu\text{Ci/ml}$  inside your incubation bottle. In case of low biomass in Arctic samples you can also use a final concentration of  $0.4\mu\text{Ci/ml}$  (e.g. Ferland et al. 2011, <http://dx.doi.org/10.1016/j.jmarsys.2011.03.015>).

Incubation bottles are filled with a measuring cylinder. The flasks should be filled up to the neck, leaving an air bubble in the flask. One dark flask from each original sample should be incubated. All places on the incubator wheel must be taken by bottles. So empty spaces should be filled with bottles filled with DI water.

### 4) Determination of total labelled carbon added:

After mixing thoroughly  $250\mu\text{l}$  (x2) from each spiked bottle into 20ml scintillation vials which contain  $250\mu\text{l}$  of ethanolamine. Keep at room temperature until measurement with scintillation counter. For counting: add 10 ml of scintillation cocktail—shake the sample.

## 5) Incubation

Incubate for 24 hours. Ideally incubation should go from dawn to dawn the next day to estimate net primary productivity. Attach the bottles with carabiners to the sediment trap rig. For incubation in holes through the ice: use a bottom weight and a line with loops to attach the carabiners. Cover the hole in the ice with the white disk.

## 6) Filtration: particulate and dissolved PP

After incubation the flask contents are filtered immediately. Maintain darkness or very low light intensities while processing the samples. In case of high algal biomass or high sedimentation load it might be needed to filter a subsample. A defined portion should be taken and filtered.

Glass-fibre filters (GF/F, Ø 25 mm) should be used, to avoid any contamination of the filter edges, prewetted filters should be used. The suction pressure should not exceed 30 kPa during filtration. The filters should be rinsed once with a small volume (5 ml) of filtered seawater from the original sample (use filtrate of the chlorophyll-a measurement!). Note: This rinsing step is debated, and some groups do not rinse the samples.

## 7) DOC production samples

If DOC is going to be measured use the following sub-sampling from the spiked sample:

Filter 3ml of the incubation from each incubation bottle through a GF/F or 0.2 or 0.4 µm filter into a scintillation vial. You can use a Syringe filter for this. Add 500 µl of 6N HCl. Leave in the fume hood for 24 hours to release of  $^{14}\text{CO}_2$ . Neutralize the sample with addition of 500µl of 6N NaOH. Add 15ml of scintillation cocktail for immediate measurement in scintillation counter.

8) Post-Processing of particulate production filters: The filters are placed in the scintillation vials under the fume hood with a drop of fuming HCl (37% or 6N) for 24 h to eliminate all the non-incorporated  $^{14}\text{C}$ . Once they are dry 6 ml of Ecolume Scintillation cocktail are added. Following addition of

scintillation liquid, the samples should be kept in dark for at least 3 hours to reduce chemiluminescence.

9) Scintillation counting: Radioactivity of the samples is determined by a liquid scintillation counter of beta particles at the University of Tromsø.

The total carbon uptake is calculated from the equation:

$$dP/dt (\mu\text{g C}\cdot\text{L}^{-1}\cdot\text{hr}^{-1}) = \frac{\text{dpm (a)} \cdot \text{total}^{12}\text{C O}_2 \text{ (c)} \cdot 12 \text{ (d)} \cdot 1.05 \text{ (e)} \cdot k_1 \cdot k_2}{\text{dpm (b)}}$$

Where

(a) = Sample activity (minus back-ground), dpm (b) = Total activity added to the sample (minus back-ground), dpm (c) = Total concentration of  $^{12}\text{C O}_2$  in the sample water,  $\mu\text{mol/L}$  (or  $\mu\text{M}$ ) (d) = The atomic weight of carbon (e) = A correction for the effect of  $^{14}\text{C}$  discrimination  $k_1$  = subsampling factor (e.g. sample 50 ml, subsample 10 ml:  $k_1 = \text{subsample factor } 50/10 = 5$ )  $k_2$  = time factor (e.g. incubation time 125 minutes:  $k_2 = 60/125 = 0.48$ )

The results will be given as  $\mu\text{g C}\cdot\text{L}^{-1}\cdot\text{h}^{-1}$  per irradiance level and as well as the photosynthesis at light saturation ( $P_{\text{max}}$ ), the maximum light utilization coefficient (a), and light saturation parameter  $E_k$ , from the P-E curve (see below).

10) Check of  $^{14}\text{DOC}$  in the stock solution: at beginning and end of the cruise fill 50 $\mu\text{l}$  of stock solution into scintillation vial. Add 0.5ml of 6N HCl and place under fume hood for 24 hours. Neutralize with 0.5ml of 6N NaOH. Add 15ml of Ecotone scintillation cocktail and keep vial in the dark until counting.

11) Calculation of total PP:

Daily production rates from each depth are integrated to using trapezoidal integration. The rate nearest to the surface is assumed to be constant up to 0m depth. The difference of DIC uptake between the dark bottle and the dark bottle with nitrification inhibitor is the DIC uptake based on nitrification. The uptake of DIC in the bottle with nitrification inhibitor is assumed to be solely by anapleurotic heterotrophic processes.

## 8.23 DETERMINATION OF PRIMARY PRODUCTIVITY RATE IN RELATION TO LIGHT INTENSITY (P VS I CURVES) USING THE <sup>14</sup>C METHOD

**Measured parameter:** Primary production rate

**Method responsible:** Rolf Gradinger (UiT, rolf.gradinger@uit.no), Philipp Assmy (NPI, philipp.assmy@npolar.no)

**Description of parameter:** Determination of the production rate of organic material by phytoplankton under defined light intensities using the <sup>14</sup>C method.

**Methodological description:**

→ **Special requirements/gear:** radioisotope container, permission to work with radioactive isotopes, incubator onboard in cold room close to in situ temperature

→ **Sampling depth(s):** Subject to change depending on context, physical and biological in situ measurements temporary depths, 10, 25, 50 75, 100, DCM and ca 2 m above sediment-water interface

→ **Chemicals used:** <sup>14</sup>C-sodium bicarbonate working solution (e.g. 20 µCi/ml), Hydrochloric acid (HCl 6M and 1M), NaOH 6N, Ethanolamine

**Material:**

- Hydrobios ICES P vs I Incubator
- Incubation bottles with light screens
- GF/F filters
- Vacuum filtration manifold with waste bottles and vacuum pump and tubing
- Tweezers (2-3)
- Excicator with fuming HCl (37%)

- Micropipets and tips (One of each: 1000  $\mu$ l, 200  $\mu$ l and 20  $\mu$ l)
- Cylinder (100 ml)
- Rinsing bottles (3x)
- Scintillation vials
- boxes to store scintillation vials for further processing back on land
- Trays for radioactive work
- Gloves (nitril size depended on operator)
- Paper towels
- Radioactive waste containers (solid, liquid)
- Absorbing bench paper
- Light sensor
- Thermometer
- 2 glass Duran bottles 0.5L
- $^{14}\text{C}$ -sodium bicarbonate working solution (e.g. 20  $\mu\text{Ci/ml}$ )
- Hydrochloric acid (HCl 6M and 1M)
- NaOH 6N
- Ethanolamine

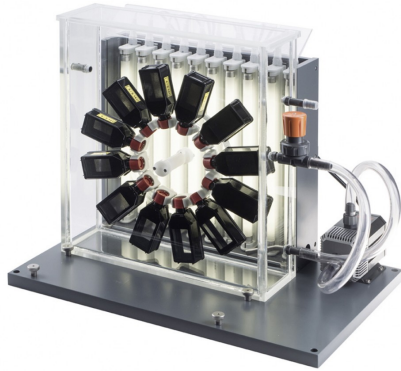
→ Assumption: DIC determined by other group, otherwise additional sampling needed.

→ **NOTE:** Always wear safety goggles, a lab coat and gloves when working with  $^{14}\text{C}$  and any hazmat (e.g. scintillation cocktail). Collect all chemical/radioactive waste in clearly labeled waste containers. Keep a clear protocol on how  $^{14}\text{C}$  has been used. This needs to be reported after the cruise.

Method (based on ICES Primary Productivity Protocol):

1) Placement of the incubator:

- Place the incubator in a dark cold room (no additional light sources) close to in-situ temperature. Use 10 fluorescent tubes (will provide approximately a light intensity of  $500\mu\text{E m}^{-2} \text{s}^{-1}$ ). Check with PAR sensor and note the correct 100% light value.



**Fig. 1** HYDRO-BIOS ICES incubator ([www.hydrobios.de](http://www.hydrobios.de))

## 2) Preparation of flasks

- Use the provided 50ml culture tissue flasks. Rinse flasks between measurements with 10% HCl, followed by distilled water. Dry before re-use.
- Do a minimum of six different light intensities for a P vs I curve from one water depth or one ice core sample.

## 3) Selection of sample

- a. Water sample: take a water sample from either the chlorophyll a maximum (if present) or from the middle of the surface mixed layer (if no maximum present).
- b. Ice sample: take one complete ice core. Cut off and use only the bottom 1 cm. Crush the ice (likely it will be in small pieces anyway if skeletal layer present). Place the sample into a clean 500ml Duran bottle. Add 400ml filtered sea water at 0-2degC from the surface. Shake distribute the ice evenly and wait until it is melted. Use the melted sample as a water

sample. Important: Note the final volume of the melted water sample to calculate the volume of the added ice sample. Take a sub sample for chl a and POC.

c. Melt pond sample: if melt ponds are available on the ice, it should be treated like a water sample from the ocean.

4) Spiking with  $\text{NaH}^{14}\text{CO}_3$  solution:

- Spike the entire volume of collected water with  $^{14}\text{C}$  in a Duran glass bottle (e.g. if you use six light intensities plus one dark bottle you will need  $7 \times 50 = 350\text{ml}$  spiked sample).
- Achieve a final concentration of  $0.1\mu\text{Ci/ml}$  inside your incubation bottle. In case of low biomass in Arctic samples you can also use a final concentration of  $0.4\mu\text{Ci/ml}$  (e.g. Ferland et al. 2011, <http://dx.doi.org/10.1016/j.jmarsys.2011.03.015>).
- Incubation bottles are filled with a measuring cylinder. The flasks should be filled up to the neck, leaving a small air bubble in the flask. One dark flask from each original sample should be incubated.
- All places on the incubator wheel must be taken by bottles. So empty spaces should be filled with bottles filled with DI water.

5) Determination of total labelled carbon added:

- After mixing thoroughly  $100\mu\text{l}$  (x2) of the spiked solution are placed in two small scintillation vials and 6 ml of scintillation cocktail is added immediately if available.
- in case direct counting is impossible the inorganic  $^{14}\text{C}$  should be mixed with ethanolamine by pipetting 0.25 ml of sample with added activity together with 0.25 ml of ethanolamine.
- 6ml of the scintillation cocktail can be added later and radioactivity determined in a scintillation counter.

6) Incubation

- The incubation time should be two hours, and the rotor should rotate ca 10 rotations/min. Note precise incubations times (by minutes). Check

proper functioning of the incubator, so that it does not stop – can be tricky....

7) Filtration: particulate and dissolved PP

- After incubation the flask contents are filtered immediately. In case of high algal biomass or high sedimentation load it might be needed to filter a subsample. A defined portion should be taken and filtered.
- Glass-fibre filters (GF/F, Ø 25 mm) should be used, To avoid any contamination of the filter edges, prewetted filters should be used. The suction pressure should not exceed 30 kPa during filtration. The filters should be rinsed once with a small volume (5 ml) of filtered seawater from the original sample (use filtrate of the chlorophyll-a measurement!).

8) DOC production samples

- If DOC is going to be measured use the following sub-sampling from the spiked sample:
- Filter 3ml of the incubation from each incubation bottle through a GF/F or 0.2 or 0.4 µm filter into a scintillation vial. You can use a Syringe filter for this. Add 500 µl of 6N HCl. Leave in the fume hood for 24 hours to release of <sup>14</sup>CO<sub>2</sub>. Neutralize the sample with addition of 500µl of 6N NaOH. Add 15ml of scintillation cocktail for immediate measurement in scintillation counter.

9) Post-Processing of particulate production filters:

- The filters are placed in the scintillation vials under the fume hood with a drop of fuming HCl (37% or 6N) for 24 h to eliminate all the non-incorporated <sup>14</sup>C. Once they are dry 6 ml of Ecolume Scintillation cocktail are added. Following addition of scintillation liquid, the samples should be kept in dark for at least 3 hours to reduce chemiluminescence.

10) Scintillation counting:

- Radioactivity of the samples is determined by a liquid scintillation counter of beta particles at the University of Tromsø.



- The total carbon uptake is calculated from the equation:

$$dP/dt (\mu\text{g C}\cdot\text{L}^{-1}\cdot\text{hr}^{-1}) = \frac{\text{dpm (a)} \cdot \text{total}^{12}\text{CO}_2 \text{ (c)} \cdot 12 \text{ (d)} \cdot 1.05 \text{ (e)} \cdot k_1 \cdot k_2}{\text{dpm (b)}}$$

Where

(a) = Sample activity (minus background), dpm

(b) = Total activity added to the sample (minus background), dpm

(c) = Total concentration of  $^{12}\text{CO}_2$  in the sample water,  $\mu\text{mol/L}$  (or  $\mu\text{M}$ ).

(d) = The atomic weight of carbon

(e) = A correction for the effect of  $^{14}\text{C}$  discrimination.

$k_1$  = subsampling factor (e.g. sample 50 ml, subsample 10 ml:  
 $k_1 = \text{subsample factor } 50/10 = 5$ )

$k_2$  = time factor (e.g. incubation time 125 minutes:  $k_2 = 60/125 = 0.48$ )

- The results will be given as  $\mu\text{g C}\cdot\text{L}^{-1}\cdot\text{h}^{-1}$  per irradiance level and as well as the photosynthesis at light saturation ( $P_{\text{max}}$ ), the maximum light utilization coefficient (a), and light saturation parameter  $E_k$ , from the P-E curve (see below for equation).

#### 11) Check of $^{14}\text{DOC}$ in the stock solution:

- at beginning and end of the cruise fill 50 $\mu\text{l}$  of stock solution into scintillation vial. Add 0.5ml of 6N HCl and place under fume hood for 24 hours. Neutralize with 0.5ml of 6N NaOH. Add 15ml of Ecotone scintillation cocktail and keep vial in the dark until counting.

## 12) Calculation of PP:

- The carbon uptake ratios (y axis) are plotted against the light intensity received by each bottle (x axis). Fit the curve based on the equation of Platt and Gallegos (1980).

$$P = P_{\max} (1 - e^{-\alpha I / P_{\max}}) e^{(-\beta I / P_{\max})}$$

- Where P is the photosynthetic rate at irradiance I,  $\alpha$  is the light-limited initial slope,  $\beta$  is a parameter describing the reduction in photosynthetic rate at high irradiance, and Pmax is a parameter equivalent to the light-saturated rate of photosynthesis when there is no photoinhibition.
- Manual for Marine Monitoring in the COMBINE program of HELCOM
- Part C: Annex C-5 Phytoplankton primary production
- Bouman et al. 2018: Earth Syst Sci Data 10: 251-266

## 9 Water samples from GoFlo bottles

### 9.1 TRACE ELEMENTS

**Measured parameter:** Particulate, total acid leachable and dissolved metal/element concentration

**Method responsible:** Murat Van Ardelan (NTNU, murat.v.ardelan@ntnu.no)

**Description of parameter:** Quantification of particulate, total acid leachable and dissolved metal/element concentration (in nmol or  $\mu\text{mol L}^{-1}$ ).

**Methodical description:**

→ **Special requirements:**

- GO -Flo bottles  
Ste line or Kevlar winch line (polymer-non-metallic line)  
Class 100-clean air laminar flow bench (place for this and additional

lab space for clean sample treatment (this space will be decked by PE sheet, and it should be in the area where there is minimal human activity (minimum turbulence)

- Lab space: minimum 4-5 m<sup>2</sup> lab space including bench and sink is needed (this space will be decked by PE sheet temporarily to create a “clean –lab / dust free environment

**NOTES:**

1-GO-FLO deployment with polymer line (either ste-line or kevlar) sampling is necessary for clean trace metal sampling

2-if Rosette sampler with Niskin bottles will be deployed with Kevlar lines, that system might be used for deep-water sampling.

→ **Sampling depth(s):** Subject to change depending on context, physical and biological in situ measurements temporary depths, 10, 25, 50 75, 100, DCM and ca 2 m above sediment-water interface

→ **Chemicals used:**

Method

- Steps after GO FLO cast completed
- GO FLO bottles will immediately be placed in the clean lab space into the GO FLO racks.
- replicate of 50 ml TTE sample (without filtration) will be collected and acidify to ca pH 1.7
- Ca 200 ml SW will be filtrate with sartobran sartorius double-layer (0.4-0.2 µm pore size) filter under Class -100 laminar flow chamber for DTE, and acidify to ca pH 1.7
- TTE and DTE samples can be stored under room temperature in triple PE bags, and send to NTNU for final SeaFAST preconcentration and HP-ICP-MS analysis

## 10 Short-time drifting sediment traps

**Measured parameter:** Sinking particles

**Method responsible:** Ulrike Dietrich (UiT, Ulrike.dietrich@uit.no), Marit Reigstad (UiT, marit.reigstad@uit.no)

**Description of parameter:**

**Methodical description:**

→ **Special requirements:** Sediment trap type: KC-Denmark

→ **Sampling depth(s):**

→ **Chemicals used:**

**Method**

- Duration of deployment ~24h
- Depths of the sediment trap cylinders are 30, 40, 60, 90, 120 and 200m.
- 2-4 cylinders per depth
- Cylinders are filled with pre-filtered deep seawater (GF/F filtrate, about 0.7 $\mu$ m pore size) prior to deployment

**Processing of core parameters:**

From each depth, Chla (size fractionated), POC/PON, stable isotope, phytoplankton and fecal pellet samples will be taken. Water from the trap are pooled before subsampling. The pooled sample needs to be thoroughly but carefully inverted before taking subsamples as the particles can sink down very quickly.

- **Chla** 100-500ml (light coloration) in triplicate
- Total Chla is filtered onto GF/F filters, Chla > 10 $\mu$ m onto 10 $\mu$ m PC filters. Otherwise the protocol for Chla samples will be followed.
- **POC/PON** 100-500ml (light colouration) in triplicate onto pre-combusted GF/F filters, wrapped in pre-combustor aluminium foil, and stored at -20C following the protocol for POC/PON samples.

- POC/PON and stable isotopes will be analyzed from the same filter simultaneously on an IRMS coupled to an elemental analyzer.
- **Phytoplankton** 100ml fixed with 4% GLA-Lugol's Solution (2ml) and stored at 4C in brown glass bottles.
- **Fecal pellets** 100-200ml fixed with buffered formalin (2% final concentration) and stored at 4C in Kautex bottles.

#### For sampling of additional components:

- This can be solved by deploying 4 cylinders at some depth to increase sample volume for extended sampling. Below extended sampling for 2018 is given.
- At 40, 90, and 120m 2 cylinders per depth will be deployed.
- At 30, 60 and 200m depth a full set of 4 cylinders will be deployed. At those depths, samples for the analysis of two types of extracellular polymeric substances (EPS) will be taken in addition, transparent exopolymeric substances (TEP) and Coomassie stainable particles (CSP).
- **TEP/CSP** concentration, 100-300ml in triplicate onto 0.4 $\mu$ m PC filters using a peristaltic pump. Filters are placed into filter holders and attached to the tubes of the pump. After the sample passed through. The filters are rinsed with air, MilliQ water, and air by attaching a syringe to the filter holder. Filters are stored in plastic cups and stored at -20C. The filtrate (50ml centrifuge tube) is collected to enumerate the dissolved concentration of TEP/CSP.
- **CARD-FISH** to identify bacteria living attached to exopolymeric particles. 100-300ml are fixed with buffered formaldehyde (ACS grade, 2% final concentration) for up to 24h at 4C in the dark. Samples are filtered onto 0.2 $\mu$ m PC filters (using filter holders), rinsed with 70% Ethanol using a syringe and placed surface up in a petri dish. Petri dishes are sealed with parafilm after all the liquid has evaporated. Samples are stored at -20C.
- In addition, samples for TEP/CSP will be taken from **suspended water** at the corresponding depths.

# 11 Net sampling

## 11.1 PHYTOPLANKTON NET HAUL SAMPLING

**Measured parameter:** Qualitative collection of protists with a phytoplankton net

**Method responsible:** Rolf Gradinger (UiT, rolf.gradinger@uit.no), Philipp Assmy (NPI, philipp.assmy@npolar.no), Bente Edvardsen (UiO, bente.edvardsen@ibv.uio.no), Luka Supraha (UiO, luka.supraha@ibv.uio.no )

**Description of parameter:** Qualitative collection of protists for: 1) documentation based on live material on board through live microscopy and video/imaging, 2) collection of concentrated material for scanning electron microscopy (SEM) analysis, 3) enriched fixed samples for sharing with taxonomic specialists, and 4) establishing of protist cultures.

**Methodological description:**

→ **Special requirements/gear:**

- Get permission from crew prior to deployment, especially if net is not towed by winch!
- Fume hood for addition of fixatives.
- MSDS sheets for formaldehyde and hexamethylenetetramine
- Waste container for gloves (preferred NITRILE)

→ **Sampling depth(s):** Vertical haul (upper 20 m) with a 10 µm hand-net (see below)

→ **Chemicals used:** 20% hexamethylenetetramine-buffered formaldehyde (final concentration 2%), Lugol's (final concentration 1%), glutaraldehyde (EM grade 25%, final concentration of 1%)

**Method:**

- Label three 100 mL brown glass bottles for fixed samples and one clear 200 mL bottle for live sample with ID.

- Connect the hand-net to appropriate rope and attach a weight (adjust weight based on type of net used; ask crew for e.g. shackles) below the cod end if needed. Use a bucket for the rope to avoid entanglement.
- Make sure that the valve of the cod end is closed when lowering the hand-net.
- Lower the net slowly to 30m depth (mark the rope), and retrieve with a slow and constant movement ( $<0.2$  m/s) back to above the water surface.
- Wait until  $<300$  ml are left in the cod end (less than entire cod end volume, dependent on hand net used), open valve and drain hand-net sample into 500 ml measuring cylinder. Fill up measuring cylinder containing the sample to 300 ml mark by flushing the mesh of the cod end with filtered sea water from squeeze bottle.
- The fixative should be added to the empty brown glass bottles prior to addition of the samples. Under fume hood, add to brown bottle 1) 10 ml of 20% hexamethylenetetramine-buffered formaldehyde (final concentration of 2%), brown bottle 2) 1 mL Lugol's (1% final concentration), and brown bottle 3) 1 mL Lugol's (1% final concentration).
- Wear gloves and work in a fume hood protection when adding formaldehyde and glutaraldehyde!
- Fill content of the measuring cylinder into three labeled and fixative containing 100 ml brown glass bottles (see picture below), ca 90 mL in each.
- Brown bottle 2: After ca 5 minutes add 4 mL glutaraldehyde (EM grade 25%, final concentration of 1%) under fume hood.
- Store fixed samples dark and cold (see below), do not freeze!
- For live samples for microscopy and cultures: Take separate net casts and fill sample into clear 200 mL bottle. Do not add fixatives and keep sample alive in cold room with white illumination (dark/light as needed).

→ **Fixed samples storage/shipment address:** Store glutaraldehyde fixed samples in fridge or cold room during the cruise (at 4°C). Make sure that bottles are safely packed for transport (hard-casing boxes with bubble-foil

filling). Formaldehyde-fixed samples should be stored at room temperature and Lugol's fixed samples should be kept at temperature about 4°C.



*Fig. 1 HYDRO-BIOS Phytoplankton hand net ([www.hydrobios.de](http://www.hydrobios.de)), left hand side, or IMR net with steel frame*



*Fig. 2 50 ml brown glass bottle*

## 11.2 MICROALGAL DIVERSITY BY CULTURING (CAPILLARY ISOLATION)

**Measured parameter:** Capillary isolation of microalgal cells for culturing

**Method responsible:** Bente Edvardsen (UiO, [bente.edvardsen@ibv.uio.no](mailto:bente.edvardsen@ibv.uio.no)),  
Luka Supraha (UiO, [luka.supraha@ibv.uio.no](mailto:luka.supraha@ibv.uio.no))

**Description of parameter:**

**Methodological description:**

→ **Special requirements/gear:** Inverted microscope, cold room or cold plate, culture chamber or culture room with white illumination.

→ **Sampling depth(s):** Vertical phytoplankton net hauls (0-30m depths) from all sampling stations

→ **Chemicals used:**



## Material:

- Pasteur pipettes that are heated and pulled out into a very thin tube (capillary), preferably with a 30° angle about 5-10 mm from the point. The diameter of the point should be 3-5 x the diameter of the cells to be isolated.
- Silicon tubing fitting to the wide end of the pipette and with a tube tip as a mouthpiece in the other end.
- Sterile Petri dishes in plastic or glass slides that must be clean.
- 50 mL tube with distilled water and 50 mL tube with algal medium
- Multiwell plates (96 wells, TPP, tissue culture testplate) with fitting lid, or glass tubes with screw lid, in rack, filled with algal medium.
- Inverted microscope with 4/5x, 10x, 20x and 40x objectives.
- Temperature control as far as possible: keep samples, petri dishes and solutions cooled on cooling elements or in a cooling box if sample is from a cold environment. If available use a microscope with a lamp with low heat emission (led).
- Plankton concentrated by net haul or a raw culture. Collect and keep the sample in a non-toxic bottle and avoid rapid changes in temperature or light shock during transportation and storage.
- The algal medium IMR 1/2 can be used for diatoms in coastal waters. For dinoflagellates and other flagellates that can be difficult to grow it may be worth to try other media such as ES- K- or L1-medium. Addition of soil extract can help. It is important to avoid salinity chock. For isolation of species that thrive in oligotrophic waters the strength of the medium can, to start with, be reduced to 1/2-1/10 of the ordinary level. Dilute, if possible, the medium with sterile sea water from the actual locality.

## Method:

1. Add 300 µL suitable algal medium into each well of a 96 well plate. Add small droplets of medium in a row in a Petri dish (about 8) or on a glass slide (3). Add a droplet of the algal sample in the first droplet.

2. Fill some medium from a tube into the capillary by capillary-forces without sucking. By this it is easier to control the water movements in point 3.
3. Localize a cell under the microscope and pick up the cell (using 4 or 10x objective) with the capillary by gently sucking on the mouthpiece, together with as little medium and other cells as possible. Transfer the cell into the next sterile droplet of medium with a gentle blow.
4. Suck up distilled water into the capillary to kill other algae that stick to the pipette and blow it out again.
5. Repeat step 2-4 with the actual droplet, so that the cell is transferred to the next unused droplet and continue until the cell is seen alone in the next droplet, upon a quick look into the microscope.
6. Suck up the cell and transfer it to a well in the Multiwell plate with unused medium. Mark the used well and make a table with information about cell ID and origin.
7. When the desired cells are isolated place the plate in a clear plastic bag to avoid evaporation and place it for growth in a culture room or incubator with light and correct temperature.
8. Check the Multiwell plates in an inverted microscope (or a stereo microscope) after about 3-4 weeks depending on temperature and growth rate. From the wells with apparently uniform cultures a droplet is examined under the microscope at higher magnifications.
9. It is important to work fast to avoid heating and desiccation that will harm or kill the cell. It is better to take a chance and isolate many cells within a short time with the danger of including a "co-passenger" in some tubes, than to stress a few cells intensively to be safe that they are clean. You can also isolate several cells of the same species in one tube /well and let them start to grow, and from this culture repeat the isolation to obtain a clonal culture (originating from one single cell).

→ **Samples storage/shipment address:** Multiwell plates containing serial dilutions should be kept in a culture room or an incubator with light/dark cycle at low temperature (4°C). During transportation put on a fitting lid and place

in a cooling box with cooling elements and fill up with packing material to avoid tilting. Transported to University of Oslo.

**Literature:**

- Andersen, R.A. & Kawachi, M. 2005. Traditional microalgae isolation techniques. In: Andersen, R. A. (ed.). Algal Culturing Techniques. Elsevier Academic Press, 578 p.

### 11.3 PROTIST DIVERSITY BY SINGLE CELL PCR

**Measured parameter:** Isolation of protist cells for single cell PCR

**Method responsible:** Bente Edvardsen (UiO, bente.edvardsen@ibv.uio.no),  
Luka Supraha (UiO, luka.supraha@ibv.uio.no )

**Description of parameter:**

**Methodological description:**

- **Special requirements/gear:** Inverted microscope, cold room or cold plate, freezer (-20°C or -80°C)
- **Sampling depth(s):** Vertical net hauls from all sampling stations
- **Chemicals used:** none

**Material:**

- Inverted microscope with objectives x4 or 5, x10, x20 and x40 magnification and x10 in the oculars with camera for photographing picked cells.
- Sterile plastic Petri dishes (10 cm diameter)
- Automatic pipette with sterile filter tips, 0.5-10µL
- Pasteur pipettes drawn out over a flame to a thin capillary with a ca 30 ° angle 1-2 cm from the tip. The diameter of the opening should be about 4-5 times the cell diameter.
- Silicon pipeline fitting to the wide end of the Pasteur pipette and a mouthpiece (e.g. pipette tip) fitted in the other end.

- Sterile filtered sea water or algal medium in 50 mL tube in a rack
- Distilled water in a 50 mL tube (for cleaning capillary)
- PCR-water (Eppendorf) in 15 mL or Eppendorf tube
- 0.2 mL PCR- tubes in cooling rack
- Cooling blocks, x2 (to cool Petri dishes and racks with samples)
- Marking pen
- Diluted net haul sample (kept cool)

Method:

1. Pick cells by capillary isolation (see separate protocol).
2. For cells sticking to the bottom of a Petri dish, such as dinoflagellates: Transfer the cell into a droplet with sterile sea water (or medium) in a Petri dish. Remove most or all of the water (but not your dinoflagellate cell) in the first drop by a clean capillary (cleaned in sterile distilled water) and quickly add a new drop of sterile sea water on top of the cell (use a sterile pipette). Repeat this washing at least once with sterile sea water, or until no other cells are seen in the same droplet. Many dinoflagellates tend to stick to the bottom of the Petri dish and then this is the easiest way. If the cells do not stick to the bottom, e.g. planktonic diatoms or flagellated haptophytes or cryptophytes, transfer a single cell from one drop to another until you have only one cell in the droplet.
3. Prior to the last washing step the cells are examined and photographed in an inverted light microscope at 200-400 x magnification.
4. Remove all water with capillary and add 10  $\mu$ l of PCR-water to the cleaned cell with an automated pipette, and the cell and water is then transferred to a 0.2  $\mu$ l PCR tube and frozen to  $-20^{\circ}\text{C}$ . Mark the tube with a code and collect information about the sample (sample ID, species etc) in a table. The cells can be stored up to several months prior to the PCR-reaction.

→ **Samples storage/shipment address:** PCR tubes with isolated single cells must be kept frozen at  $-20^{\circ}\text{C}$  prior to the PCR reaction.

## Literature:

- Edvardsen et al. 2003. Genetic variability and molecular phylogeny of Dinophysis species (Dinophyceae) from Norwegian waters inferred from single cell analyses of rDNA. J. Phycol. 39: 395-408.

## 11.4 ZOOPLANKTON SAMPLING

*Tab. 1 Overview of zooplankton sampling during Nansen Legacy cruises from August 2019 onwards.*

Gear	cast no.	Size group	Sample-type	Label	Depth	Mode of sampling	Regular station	Process station
Niskin		Microzooplankton	Abundance	MIT-001	same as particulates	vertical		x
Multinet 64 µm	1	Small mesozooplankton	Abundance	SMT-001	bott-200-100-50-20-0m	vertical	x	x
Multinet 180 µm	2	Mesozooplankton	Abundance	MET-001	bott-200-100-50-20-0m	vertical	x	x
Macrozooplankton trawl 3 mm	3	Macrozooplankton	Abundance	MZT-001	bottom-0m	v-haul	x	x
Macrozooplankton trawl 3 mm	3	Macrozooplankton	Biomass	MZB-001	bottom-0m	v-haul	x	x
Macrozooplankton trawl 3 mm	3	Macrozooplankton	Genetics	MZG-001	bottom-0m	v-haul	x	x
WP2 180 µm	4	Mesozooplankton	Biomass	MEB-001	bottom-0m	vertical		x
WP2 180 µm	4	Mesozooplankton	Genetics	MEG-001	bottom-0m	vertical		x
WP3 1000 µm	5	Mesozooplankton	Ecotox/SI/Lipids		biomass layer	vertical		x
MIK 1.5 mm /Macroplankton net x mm	6	Macrozooplankton	Ecotox/SI/Lipids		biomass layer	vertical		x
MIK 1.5 mm /Macroplankton net x mm	6	Gelationius zooplankton	Other			vertical		
MIK 1.5 mm /Macroplankton net x mm	6	Fish larvae	Other			vertical		

### 11.4.1 Microzooplankton abundance & biomass

**Measured parameter:** Abundance and biomass

**Responsible scientist(s):** Nicole Aberle-Malzahn (NTNU, Nicole.aberle-malzahn@ntnu.no)

**Description of parameter/Aim:** Provide information on microzooplankton seasonal, annual and regional variations in abundance, biomass and species composition along a latitudinal environmental gradient in the Barents Sea from South to North.

## Methodological description:

- **Special requirements/gear:** Niskin bottles (24 x 10L rosette)
- **Sampling depth(s):** Process stations only: 100, 50, 20, 10, 0m + Chl max (adjust the depth to the same depth as for water chemistry)
- **Chemicals used:** none

## Method

Seawater should be transferred to 250/500 ml brown glass bottles and fixed with 1% acidic Lugol's iodine solution

→ **Sample storage:** Samples stored dark and cold (4°C) until analyses

### 11.4.2 Mesozooplankton

**Measured parameter:** Mesozooplankton abundance, biomass and species composition

**Method responsible:** Anette Wold, NPI (anette.wold@npolar.no), Janne Søreide, UNIS (janne.soreide@unis.no) and Camilla Svensen, UiT (camilla.svensen@uit.no)

**Description of parameter/Aim:** Provide information on mesozooplankton seasonal, annual and regional variations in abundance, biomass and species composition along a latitudinal environmental gradient in the Barents Sea from South to North.

#### 11.4.2.1 Mesozooplankton abundance/taxonomy

**Measured parameter:** zooplankton abundance (ind/m<sup>3</sup>) and biomass (mg C/m<sup>3</sup>)

**Method responsible:** Anette Wold, NPI (anette.wold@npolar.no), Janne Søreide, UNIS (janne.soreide@unis.no)

**Description of parameter:** Provide information on mesozooplankton seasonal, annual and regional variations in abundance, biomass and species composition along a latitudinal environmental gradient in the Barents Sea from South to North.

**Methodological description:**

→ **Sampling depths:**

- Bottom depth <600m (5 depths): bottom-200; 200-100; 100-50, 50-20 and 20-0 m
- Bottom depth >600m (5 depths): bottom-600; 600-200; 200-50; 50-20; 20-0 m

→ **Chemicals used:** 37% formaldehyde free from acid, 96% non-denatured EtOH

**Material and Method:**

- **Stations:** All process stations
- **Gear:** Multinet midi 180 µm mesh size (opening 0.25m<sup>2</sup>), see Multinet manual section

**Sample treatment:**

- The nets should be rinsed and samples should be treated as gentle as possible throughout the process.
- Samples should be processed immediately after sampling.
- Gelatinous zooplankton should be removed prior to preservation, by use of plastic pipette or spoon with wholes, over a light table/ or white tray. See the section "Gelatinous zooplankton"
- Filter the rest of the content of the sample through a 180 µm sieve placed over a white tray in case something gets spilled.
- Move the samples from sieve into 125 ml bottle, fill the bottle to the neck with sea water
- Samples are preserved with Formaldehyde 37% (stabilised for histology free from acid).

**Labels:** Use UUID labels including short human readable ID

#### *11.4.2.2 Small mesozooplankton abundance/taxonomy*

**Measured parameter:** zooplankton abundance (ind/m<sup>3</sup>) and biomass (mg C/m<sup>3</sup>)

**Method responsible:** Camilla Svensen, UiT (camilla.svensen@uit.no), PhD tba (UiT)

**Description of parameter:** Provide information on small mesozooplankton seasonal, annual and regional variations in abundance, biomass and species composition along a latitudinal environmental gradient in the Barents Sea from South to North.

**Methodological description:**

→ **Sampling depths:** (same as Multinet 180 µm)

- Bottom depth <600m (5 depths): bottom-200; 200-100; 100-50, 50-20 & 20-0 m
- Bottom depth >600m (5 depths): bottom-600; 600-200; 200-50; 50-20; 20-0 m

→ **Chemicals used:** 37% formaldehyde free from acid, 96% non-denatured EtOH

**Material and Method:**

- **Stations:** All process stations
- **Gear:** Multinet midi 64 µm mesh size (opening 0.25m<sup>2</sup>) → See Multinet manual for details
- **Sample treatment:** Same as for mesozooplankton abundance
- **Labels:** Use UUID labels including human readable ID

#### *11.4.2.3 Mesozooplankton genetics & biomass*

**Measured parameter:** Genetics and biomass

**Method responsible:** Kim Præbel (UiT, kim.præbel@uit.no)

**Description of parameter:**



### Methodological description:

→ **Sampling depth:** Bottom-0 m

→ **Chemicals used:** non-denatured 96% EtOH

### Material and Method:

- **Stations:** Standard stations & process stations
- **Gear:** WP2 180 µm (60 cm dia./0.25m<sup>2</sup> opening)

### Sample treatment:

- Samples should be split into genetic & biomass samples by use of a Metoda plankton splitter.
- From the biomass fraction, should we should sort out larger specimen such as krill and amphipods and treat the rest as one sample. Gelatinous zooplankton should also be picked out prior to preservation in the same manner as for the abundance samples.
- These biomass samples should be dried at 60°C for 24 hours and weighted. For large organisms like medusae and ctenophores their volume fraction are determined by displacement volume onboard the vessels.
- If the biomass samples is not dried and weighted it should be frozen (-20°C)
- The genetic fraction should be stored on 90% ethanol and kept? refrigerated in the dark? In -20°C?

**Labels:** Use Pre-printed Mesozooplankton genetics & Mesozooplankton biomass UUID labels

### 11.4.3 Macrozooplankton abundance, biomass & genetics

**Measured parameter:** Wet-weight per taxonomic group per m<sup>-3</sup> and length measurements

**Method responsible:** Espen Bagøien, IMR (espen.bagoien@hi.no)

**Description of parameter:**

## Methodological description:

→ **Sampling depths:** 700m (or near bottom) to surface

- **Open water** - Use the Macroplankton trawl for collection of organisms by oblique V- hauls down to bottom (30 m safety limit to bottom) - or to 800 m when bottom-depth exceeds this depth - and then up to the surface again (2.0-2.5 knots)
- **In Ice** - Use Macrozooplankton ring net vertically (bottom - surface) or MIK net using V- hauls if ice condition permits.

→ **Chemicals used:** 4% formaldehyde free of acid

## Material and Method:

- **Stations:** Standard stations & process stations
- **Gear:**
  - Macrozooplankton trawl (open water): opening area 38 m<sup>2</sup> mouth, 3 mm mesh size.
  - Macrozooplankton ring net (in ice): opening area 2.01 m<sup>2</sup>, 7 m long net bag with 1.55 mm or 4 mm mesh size.

## Sample treatment:

Some Macroplankton trawl catches may be so large that quantitative subsampling is required during sample processing. The samples or subsamples should be completely worked up on board according to traditional pelagic trawl sampling procedures (described below).

**Processing of samples from Macroplankton trawl:** Weigh the total catch - regardless of whether small or large. For small catches: Work up everything.

For large catches; Take a representative, **random** subsample. Important: **Note the weight of both the total catch and the subsample(s)**. Large species must be sorted out first. **Occasionally it will be necessary to subsample on multiple levels to register rare species:**

- 1) Large specimens are sorted out first (jellyfish, fish, squids, etc.) – preferably from the total catch - before subsampling. Species are determined, and the numbers, weights and lengths recorded species-wise. How to treat the jellyfish for subsequent analyses is described below
- 2) The “rest” of the sample – or a subsample from the “rest” - is then sorted down to species or lowest possible taxonomic level. Note number and weight for each species. If there is a “gelatinous slime”, try to sort this out and store it separately. It might contain interesting specimen e.g siphonophores.
- 3) For krill, amphipods, shrimps, mesopelagic fish and squids; measure the total

length of 100 – 300 individuals of each species. Record weight of each length-measured sample.

- 4) Freeze the length-measured specimens at -20 °C, each species in a separate bag for later analysis.
- 5) For large samples: Fix a representative and quantitative subsample from the “rest” of the catch with 4% formaldehyde neutralized with sodium tetraborate (a “special spoon” for borax is added per 100 ml 4% formaldehyde). This is particularly important for krill and amphipods, as these samples will allow for later analysis of gonad maturation, external maturity, sexual characteristics, etc.
- 6) For large samples: Fix a representative and quantitative subsample from the “rest” of the catch with ethanol. This is particularly important for krill and amphipods, as these samples will allow for later analysis of nutrition estimates, lipids, genetics, etc.
- 7) Additionally, qualitative samples of krill (N~100) and amphipods (N~100) are to be deep-frozen – in a “flat rather than lumped” manner - for later analysis of stomach contents, etc.
- 8) Exotox group lead by Katrine Borga need some macrozooplankton for toxin/pollution analyses – make sure to provide them the species and amount needed for their different analyses.
- 9) Nicole is to be provided any fish larvae (other types of organisms as well?) that are caught by sampling of macroplankton. Also make sure that Nicole receives all the macrozooplankton she needs for analyses of trophic level, lipids, etc

Note the results of the work up in the Macroplankton Trawl Workup form and the Length Measurement Form for Krill / Fish (c.f. IMR's Plankton manual (in Norwegian), Appendix 18 &19

### **Gelatinous zooplankton:**

Ctenophores and scyphozoa must be removed from samples – preferably before subsampling – and preservation and freezing. The species, and their numbers and sizes are to be recorded, photo-ID should be taken and the animals are then frozen down species- wise for later biomass/nutrition estimation and potentially DNA analyses.

The large scyphozoans and ctenophores are generally ok to pick out (e.g. Aurelia, Periphylla, Cyanea, Beröes, Atollas). Note that there may be several species of e.g. Beröe and Atolla present, and it should be considered how to best get the species ID (this can be tricky). Interesting species to watch out for in the Arctic include Marrus sp. Siphonophores and Aulacoctena ctenophores.

Note the comment about “gelatinous slime” above.

**Registration of data:** All data from the Macroplankton trawl must be registered in the IMR Plankton database (latest version of “RegPlankton”). Keep paper journal in addition.

#### **11.4.4 Zooplankton acoustics EK80**

**Measured parameter:** Zooplankton acoustics

**Method responsible:** Randi Ingvaldsen (IMR, randi.ingvaldsen@hi.no)

**Description of parameter:**

**Methodological description:**

Acoustic surveying on the Nansen Legacy surveys will be conducted using the six scientific Simrad EK80 echo sounders, all mounted on the drop keel, and simultaneously operated from a common computer. These are the 18kHz, 38kHz, 70kHz, 120kHz, 200kHz, 333 kHz split beam systems. When ice conditions are such that the keel transducers can be operated, they are the

preferred systems used. When ice conditions are such that the keel must be retracted, and protected, the data collection will continue with similar systems mounted in Arctic tanks. As the echo sounders now must be operated through relatively thick protective windows, the noise level and measurement conditions will be worse. The decisions on when to switch systems will be taken by the captain or bridge personnel.

EK80 should be run in CW modus during the first year of operation (until 2019) or until otherwise decided. The echo sounders should be calibrated at the start of the surveys, and when the survey will enter the above-mentioned conditions, both systems should be calibrated.

Multi-frequency scrutinization and target strength analysis will be conducted daily for the 38kHz data with the Large Scale Survey System (LSSS) post-processing system (Korneliussen et al., 2006, 2016), which also will be used for exporting files for subsequent analysis. The processing will involve manual removal of unwanted acoustic noise from e.g., trawl sensors during trawl operations. Simultaneous current measurements will be made with RDI 150 kHz ADCP, externally triggered by the echo sounder as a master. A fixed time delay in transmission should be implemented to prevent interference from the ADCP transmit pulse to the echo sounder data.

Interpretations will be made per standard procedures where the total backscatter will be split into target categories like (see ICES, 2015; Korneliussen et al., 2016). Categories used for the Nansen Legacy will be: capelin, herring, polar cod, blue whiting, Norway pout, cod, haddock, redfish, saithe, O-group mixed, plankton mixed and other scatterers, in accordance with the protocol for acoustics during the ecosystem survey.

The scrutinized acoustic backscattering data in the echo sounder output will be in the form of the Nautical area scattering coefficient (NASC) in standard units; ( $m^2 nmi^{-2}$ , MacLennan et al., 2002). They will be integrated to 10-m depth bins relative to the sea surface, starting from about 15 m depth, depending on the draft of the transducers. The scrutinized data will be stored in accordance with standard procedures at IMR:

[//kvalitet.hi.no/docs/pub/dok03896](http://kvalitet.hi.no/docs/pub/dok03896).

(Literature: Prosedyre for innsamling og bearbeiding av akustikkdata  
(Procedure for collection and treatment of acoustic data.)

### Acoustic probing

Detained inspections at short range of interesting layers in the Arctic may be made with acoustic / optic probing. A specially designed probe with full wideband capacity with carry 4 EK80 echo sounders with 5 selectable transducers, 38,70, 120, 200 and 333 kHz will be used in profiling mode (transducers in horizontal mode), and the multi-frequency echo sounder observing to 50 m to the side of the probe will be run at high PRF (3–4 Hz) while the probe is lowered from surface to the bottom (max 1500 m depth) at about 1 ms<sup>-1</sup>. Full multi-frequency echograms will be recorded during the profile, and still photo images from a stereo camera will be captured during retrieval. Scrutinizing and storing the probe data to a local database will be made according to procedures under development. The echo sounders will be calibrated at the start of the survey (or during the survey with stationary vessel for a few hours. The TS probe will be run on every primary level stations, where biological sampling is conducted to support the acoustic data collection. The probe may alternatively be used in vertical mode, for target strength measurements of specific organisms in pure concentrations. These numbers are needed for several of the Arctic categories for accurate density estimation from the vessels-based systems.

### Literature

- ICES (2015). Manual for International Pelagic Surveys (IPS). Series of ICES Survey Protocols SISP 9 - IPS. 1–92.
- Korneliussen, R. J., Heggelund, Y., Macaulay, G. J., Patel, D., Johnsen, E., and Eliassen, I. K. (2016). Acoustic identification of marine species using a feature library. *Methods Oceanogr.* 17, 187–205. doi: 10.1016/j.mio.2016.09.002.
- Korneliussen, R. J., Ona, E., Eliassen, I., Heggelund, Y., Patel, R., Godø, O. R., Giertsen, C., et al. (2006). “The large scale survey system - LSSS,” in *Proceedings of the 29th Scandinavian Symposium on Physical Acoustics (Ustaaset)*.
- MacLennan, D. N., Fernandes, P. G., and Dalen, J. (2002). A consistent approach to definitions and symbols in fisheries acoustics. *ICES J. Mar. Sci.* 59, 365–369. doi: 10.1006/jmsc.2001.1158

#### 11.4.5 Macrozooplankton for ecotox, stable isotopes & lipid samples

**Measured parameter:** Organic pollutants, stable isotopes, fatty acids, Hg, Carbohydrates, Proteins and Energetics (see protocol for RF221 & F225)

**Method responsible:** Katrine Borgå (UiO, katrine.borga@ibv.uio.no)

**Description of parameter:**

**Methodological description:**

→ **Sampling depths:** Samples will be collected from two distinct depth layers containing Atlantic & Arctic water masses. The depth will be decided depending on CTD profile.

→ **Chemicals used:** No chemicals used. All samples will be frozen

**Material and Method:**

- **Stations:** Process stations only
- **Gear:** WP3 1000 µm & Macrozooplankton trawl or Macrozooplankton net
- **Sample treatment:** Samples will be sorted to species or higher taxa, see protocol for RF 2 regarding the amount needed for the different sample types and pay attention to avoid contamination

### 11.5 MANUALS ZOOPLANKTON NETS

#### 11.5.1 Multinet manual

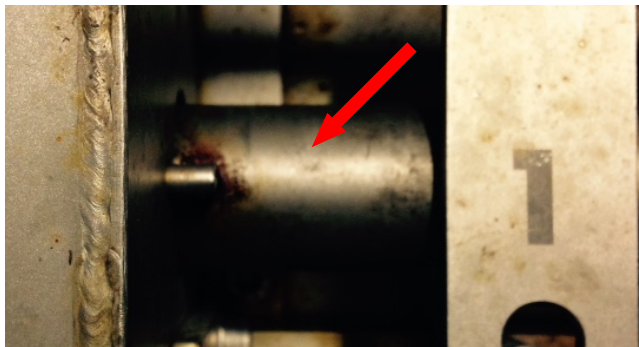
**Specification:** Opening 50cm\*50 cm = 0.25m<sup>2</sup>, size of box: 80 cm\*90 cm\*95 cm, 5 net bags 250 cm long with mesh size of 180 µm & 64 µm, overall length 560 cm.

**Introduction:** The Multinet is deployed with all net bags closed and the water flowing freely through the frame. The instrument can be lowered with high speed to the greatest desired depth. It can either be operated by use of communication cable and deck unit and nets can be opened manually or it can be used off-line by pre-programming it as described below. All measuring data

are stored inside the internal data memory during the operation and can be read out by a PC when the Multinet is back on board.

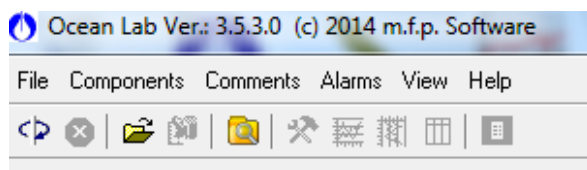
### Deployment:

**Off-line preparation of Multinet:** Check that the small pin on the rotating cylinder is in the right position (if not see instructions below).



**Fig. 1** There is a small pin on the rotating cylinder which should point straight at the pin seen here.

1. Turn on the Multinet
2. Connect Multinet to the Toughbook, open program "OceanLab3" from desktop.
3. Check the battery (3\* Lithium 123A/ 3V status), should be >7.
4. Connect to Multinet using *connect symbol* (1<sup>st</sup> from left in menu bar)

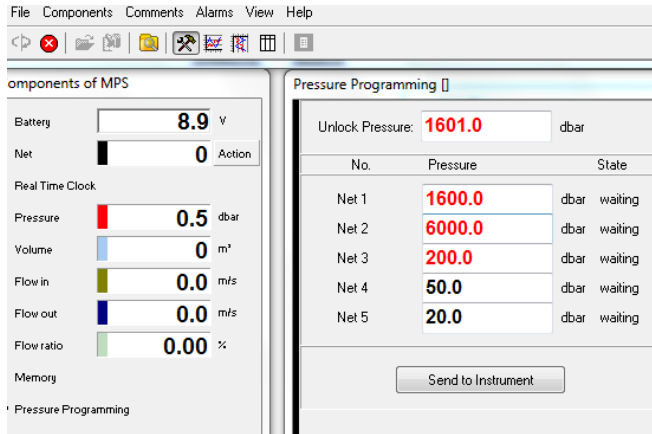


**Fig. 2** Menu bar of the Ocean Lab software

5. Open the *control mode* (6<sup>th</sup> from left in menu bar)
6. Choose *Pressure programming* to program the releasing depth. Remember that the Unlock depth must be minimum 1 m below the depth of the 1<sup>st</sup> net. The nets do not open if the Multinet has not been set below the unlock depth. Always go at least 5 m below to make sure it opens (if not the cast needs to be repeated).



## 7. Send to Multinet.

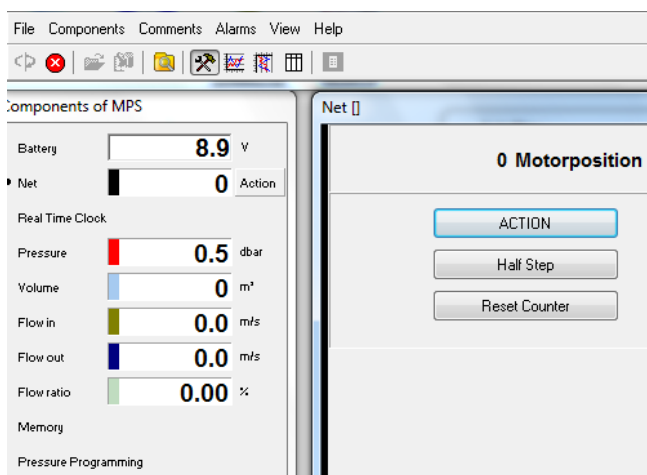


**Fig. 3** Pressure programming. Unlock pressure needs to be deeper than opening depth of Net 1

→ **NOTE:** Depth of Net 2 is wrong in this picture, should be 600m

## 8. Disconnect Multinet. Remember to put dummy plug back on.

→ If not all the net opened during the previous deployment, check that the small pin of the rotating cylinder that controls the opening of the nets, is in the right position, pointing straight up towards the pin at the net (see picture above). If not mark *Net* and reset the rotating cylinder either by using *reset counter* or *half step*.



**Fig. 4** Mark Net in the right menu and use Half step to reset rotating cylinder

9. Prepare the nets (strain the spring by using the bar to lift them into position).



*Fig. 5 The springs are in this position before they are strained.*

- Net #1 samples the deepest layer, Net# 5 the surface layer.
- Make sure that cod ends are placed at the right net (check numbers)!
- Make sure that the nets are not twisted before the Multinet is lowered into the water.
- The weight of the lower part of the Multinet should be entirely supported by the ropes and not by the nets! (The nets have to hang loose, the ropes should be straight).
- More information can be found in the “Multiplankton Operational Manual from HydroBios”.

### 11.5.2 Macroplankton trawl

**Specifications:** 38 m<sup>2</sup> mouth opening, mesh-size of 3x3 mm throughout the trawl – from opening to cod-end, total length of about 45 m.

**Background info:** The Macroplankton trawl (Melle et al., 2006; Krafft et al., 2010; Heino et al., 2011) has been used regularly by IMR since 2010 to obtain

quantitative samples of macrozooplankton, particularly for krill, amphipods, shrimps, and mesopelagic fish. This trawl will also give improved quantitative estimates of various types of jellyfish, in particular for scyphozoans but also for ctenophores. It should also be used as an additional gear for ground-truthing of acoustic scattering layers – i.e. for identifying which type of organisms the SL's contain. This is particularly relevant in cases when the scattering structures (dense or diffuse) are suspected to be caused by macrozooplankton.

**Deployment:** V-hauls are applied for quantitative estimation of macrozooplankton abundances. The aim is that the trawl moves through the surrounding water with a speed of ca. 3 knots (affected by both vessel-speed and release/hauling-speed of wire) – both on the way down and up. After the trawl has reached its maximum depth, ship speed should be approximately 2.0 knots while the trawl is hauled obliquely towards the surface - heave as slowly as possible. Make sure that the height of the trawl opening is ca. 5 m during trawling – large departures from this height may indicate that the trawl is not behaving as it should – and the sample may then not be useful/valid.

It is important to attach a Scanmar trawl-eye and speed sensor for monitoring trawl performance. Data from these sensors must be logged on the computer at the ships bridge for later determination of trawl profile and volume of water sampled.

#### Literature

- Heino, M., Porteiro, F.M., Sutton, T.T., Falkenhaus, T., Godø, O.R., Piatkowski, U., 2011. Catchability of pelagic trawls for sampling deep-living nekton in the mid-North Atlantic. *ICES Journal of Marine Science* 68, 377–389.
- Krafft, B.A., Melle, W., Knutsen, T., Bagøien, E., Broms, C., Ellertsen, B., Siegel, V., 2010. Distribution and demography of Antarctic krill in the Southeast Atlantic sector of the Southern Ocean during the austral summer 2008. *Polar Biology* 33, 957–968.
- Melle, W., Abrahamsen, M., Valdemarsen, J.W., Ellertsen, B., Knutsen, T. 2006. Design and performance of a new macro-plankton trawl in combination with a multiple cod-end system. *SCOR Working Group 115, Mini Symposium on Standards for the Survey and Analysis of Plankton*. Plymouth, England. 19-20 May 2006.
- Wenneck, T.dL., Falkenhaus T., Bergstad OA (2008). Strategies, methods, and technologies adopted on the R.V. G.O. Sars MAR-ECO expedition to the Mid-Atlantic Ridge in 2004. *Deep Sea Research II*. 55: 6-28.

### 11.5.3 Macrozooplankton ring net

**Specifications:** Opening area of 2.01 m<sup>2</sup> and a 7.0 m long net bag with 1.55 mm mesh or 4 mm mesh size.

### 11.5.4 WP2/WP3 net

**Specifications:**

- WP2 stainless steel ring of diameter 57 cm, mesh size 180 µm & 64 µm mesh size, length 2.6 m
- WP3 stainless steel ring of diameter 1 m, mesh size 1000 µm, length 2.6m

**Deployment:** Both WP2/ WP3 nets are deployed vertically. Both nets can be closed at specific depth by use of a messenger if needed.

## 11.6 PTEROPOD SAMPLING WITH WP2

**Measured parameter:** Pteropod (*Limacina limacina*, shelled butterfly snails) collection

**Method responsible:** Agneta Fransson (NPI, agneta.fransson@npolar.no) and Melissa Chierici (IMR, melissa.chierici@hi.no)

**Description of parameter:** Key indicator for ocean acidification effects, study shell condition, shell density and size (thickness, mm; size, mm) using several techniques (SEM and MicroCTtomography). Species abundance and specie.

**Methodical description:**

→ **Special requirements:**

→ **Sampling depths:** For WP2 sampling, surface to 50 m, vertical and oblique tows. For multinet sampling, 5 depths from surface to 200m

→ **Chemicals:**

Method

- WP2 net (see below)
- Multinet (see 10.4.2.2)

→ **Sampling time:** maximum 1 hr, general 5 stations (defined process stations), important that sampling is performed at same stations as water sampling (and CTD) for carbonate chemistry and nutrients.

→ **How to fix the net:**

Connect the ring to the net (see picture guide below)



Connect the cup to the net



Insert the cup in the metal box



Connect the box to the net



→ **NOTE:** no twists (check before and during the net deployment)

Check presence of holes in the net (after each sampling) and eventually use tape to repair it



→ **NOTE:** Check the safety closure for the cup

### Collecting samples

1. From 50m to surface
2. Vertical speed velocity:
3. Upward WP2 speed 0,5 m/sec
4. Downward WP2 speed 1m/sec
5. Before the recovering, when the WP2 is still out (before putting on the deck) wash it from outside with seawater pump in order to get all the sample into the cup
6. Attention: no recovering the WP2 from the net but always from the metal box
7. Put the cup with the samples inside a bucket and open the cup.

8. Use the deck sea water pump (from outside to inside!) to clean the cup in order to recovering all the sample
9. Wash the WP2 with fresh water

### Reducing Volume and Storage:



Move the samples to a bucket and pick out pteropods in approximate size, bigger swimming ones and smaller may be non-swimming but at the bottom of the bucket. Use a spoon, small tea-filter or pipette with larger opening (cut the end of a plastic disposable pipette).



Divide the specimens in size and put into vials with buffered Ethanol quickly after recovery. Avoid adding too much seawater to the vials.

Put the material in the bottle with ethanol (buffered w hexamethyltetramine). In some cases, a spray bottle with ethanol may help, but be careful not to break the shells which are very fragile.

Label the bottles (date, station, depth, approx. size, swimmers/non-swimmers) or only write a number and then log that number in logbook with details.



## 11.7 PLANKTONIC FORAMINIFERA SAMPLING WITH MULTINET

**Measured parameter:** Planktonic foraminifera species abundance and species composition, state of shell dissolution and shell thickness (shell weight and size analyses, SEM).

**Method responsible:** Agneta Fransson (NPI, agneta.fransson@npolar.no) and Melissa Chierici (IMR, melissa.chierici@hi.no)

**Description of parameter:** Planktonic foraminifera are key indicators for ocean acidification effects.

**Methodological description:**

→ **Special requirements:**

→ **Sampling depths:** Surface to: 30, 50, 100 m. The sampling depths will be estimated at each station and will depend on the vertical water mass distribution.

→ **Chemicals**

**Sampling time:** maximum 1-2 hr, general 5 stations (defined process stations), important that sampling is performed at same stations as water sampling (and CTD) for carbonate chemistry and nutrients.

**Net equipment:**

- MultiNet with 5 net bags with mesh size of 63  $\mu\text{m}$  and 90  $\mu\text{m}$
- Specification: Opening 50cm\*50 cm = 0.25m<sup>2</sup>, size of box: 80 cm\*90 cm\*95 cm, 5 net bags 250 cm long, overall length 560 cm.

## 12 Benthic sampling

This section contains information on planned seafloor sampling during joint AeN cruises. It has a focus on benthic organism sampling and processing as well as sediment sampling and processing where of joint biological-geological interest. We refer to sampling protocols provided by the geology team in several cases and for variables not of direct relevance to biologists in the project.

### 12.1 AEN TEAM MEMBERS INTERESTED IN BENTHIC INVERTEBRATE SAMPLES AND SEABED SEDIMENT SAMPLES

Sediment sampling is relevant for RF1 and RF3. Benthic invertebrate sampling is mostly relevant for RF3, with Foraminifera also of interest for RF1. Researchers interested in seafloor sampling (as of April 2018) are listed in Table 1. This list will obviously need updating as PhD students and Post-docs are hired into the project and other team members join.

*Tab. 1 Researchers interested in seafloor sampling in the Nansen Legacy as off August 2018.*

RF / RA	Name	Institution	Role	Topic
RF1, 3	Elisabeth Alve	UiO	Sci	Foraminifera
RF1	Murat Ardelan	NTNU	Sci	Trace metals
RF3	Bodil Bluhm	UiT	Sci	Biodiversity & community structure, food webs, population dynamics
RF3	Gunnar Bratbak	UiO	Sci	Sediment microbial communities
RF2	Kathrine Borgå team?	UiO	Sci + PhD?	Contaminants
RF3	Raphaëlle Descoteaux	UiT	PhD (Arctic	Meroplankton, benthic juveniles, barcoding, molecular diets

			SIZE)	
RF1	Matthias Forwick	UiT	Sci	Geology
RF1	Katrine Husum	NPI	Sci	Geology, sediment properties (grain size, OC)
RF3	Lis L. Jørgensen	IMR	Sci	Biodiversity & community structure, traits, vulnerability, management
RF1	Ulysses Ninnemann	UiB	Sci	Palaeoclimate, isotope geochemistry
RF1	Tine Rasmussen	UiT	Sci	Geology, pore water profiles, pH
RF3	Paul Renaud	APN	Sci	Benthic community respiration,
RF3	Luka Supraha	UiO	PhD	Phytoplankton spores
RF3	Emmelie Åström	UiT	PD	Food web, stable isotopes
RF3	NN	IMR	PD	Food web
RF3	NN	UNIS/UiT	PhD	Molecular diets plankton / meiofauna
RF1, 3	Marianne Risager Kjøller	UiO	PhD	Foraminifera

## 12.2 SAMPLING GEAR

Sampling gear targeting sediment and organismal samples in AeN is listed in Table 2. Benthic meiofauna will be sampled with a Gemini-corer (back up gear is a box core). Macrobenthos (terms used synonymously with infauna here) and microbes will be sampled with a box corer (back up gear is a van Veen grab), and megabenthos (term used synonymously with epifauna here) will be

sampled with beam and Campelen trawls. Sediment for shared biological and geological variables will be sampled with a box corer (again, back up gear is a van Veen grab).

Naturally, the sampling depth of all sampling gear matches the total depth of a given station. Appropriate knowledge of the bottom depth from the ship's depth sounder is, therefore, a requirement. Knowledge on bottom topography and sediment type from multi-beam mapping is desirable.

Note that geologists prefer multi-corer samples for their measurements and will use that gear type during their cruises. In joint cruises where no geologists participate, select sediment properties will be sampled from box cores.

### 12.3 GEAR SPECS AND DEPLOYMENT IN BRIEF

**Tab. 2** *Sampling gear for sediment and benthic organisms to be used during AeN (in alphabetic order).*

Gear type	Owner(s)/ responsible	Potential users	Sampling goals	Cruises
Beam trawl	IMR/Jørgensen	RF3	Epifauna for population parameters / ECOPATH, fish, food web, barcoding, contaminants	All JC / seasonal cruises
Box corer	Geology UiT/Forwick, NPI/Husum	RF1, 3 (2?)	Sediment grain size, organic carbon content, pigments (chlorophyll, phaeopigments), macrofauna (juveniles / adults, for experiments, quantitative, for population parameters / ECOPATH), fauna, food web, pH (Geo cruises), oxygen (Geo cruises)	All JC / seasonal cruises
Campelen trawl	IMR/Jørgensen	RF3	Epifauna (quantitative); for population parameters / ECOPATH,	All JC / seasonal cruises

			fish, food web, barcoding, contaminants	
Gemini core	UiO/Alve	RF1/3	Foraminifera (quantitative, for experiments); all meiofauna for quantitative estimates, food web (isotopes, molecular diets)	Seasonal cruises
Van Veen grab → backup for Box corer	BFE UiT/Bluhm, APN/Renaud	See box core	See box core	All JC / seasonal cruises

### 12.3.1 Galvanize steel beam trawl (Figure 1a,b)

- 1 haul per station
- Mesh size: 20 mm (10 mm knot to knot)
- Effective opening: 2 m
- No sensors
- Trawl data needed: latitude / longitude at bottom and off bottom, water depth, time at bottom and off bottom, station number, ship speed (available on screens around ship)
- Deploy at scope ca. 2
- Bottom time 3 min
- Trawl at 1.5 kn
- Wire in/out at  $1\text{ms}^{-1}$
- Empty on deck / sorting table
- Specs in Jennings et al. 1999

### 12.3.2 Box corer (Figure 1e)

- 4 cores per process station (possibly more during seasonal cruises where respiration incubations will be made)
- 3-4 cores for quantitative macrofauna sampling (when quantitative sampling is a goal)
- Box size: 0.5 x 0.5 x 0.5 m or smaller
- Amount of weight on top: 4x25kg or 4x50kg
- To deploy, open spade
- Data needed: latitude / longitude, water depth
- Fix release mechanism to keep spade open
- Lower to seafloor at 1 m s<sup>-1</sup>
- Lower speed to 0.5 m s<sup>-1</sup> near seafloor to avoid loss of sediment surface layer and organisms
- Weight will push core into sediment
- Release will pop out upon the corer touching the seafloor
- Upon slow retrieval from sediment, spade will close
- Place on deck very carefully to reduce sediment surface disturbance
- Upon retrieval, unscrew box with sample, fix new box for next replicate

### 12.3.3 Campelen 1800 with Rockhopper ground-gear trawl (1c,d)

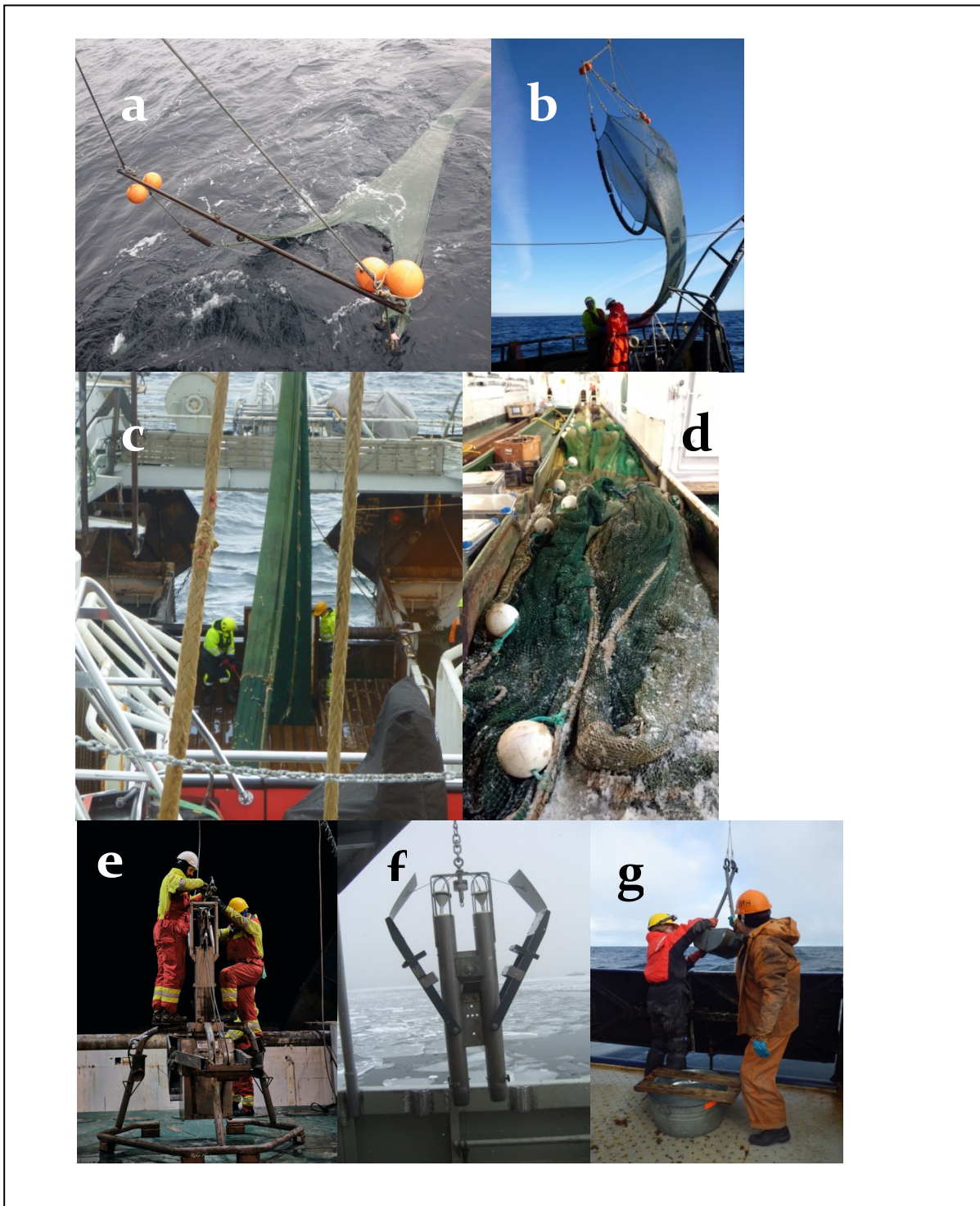
- 1 haul per main station
- Mesh size: 80 mm in wings, 16-22 in the cod end
- Bottom time 15 min (should be equivalent to towing distance of ca. 0.75 nautical miles or 1.4 km)
- Trawl speed ~3 kn
- Target net opening ca. 17 m horizontal, 4 vertical
- Trawl data needed: latitude / longitude at bottom and off bottom, water depth, time at bottom and off bottom, station number, ship speed, door opening (scanmar sensors) (available on screens around ship)
- Deploy at scope appropriate to depth and sediment (get from fish team)
- Wire in/out at 1 m s<sup>-1</sup>
- Empty into chute that leads to inside fish sorting table
- Specs in Engås and Ona 1990

#### 12.3.4 Gemini corer (Figure 1f)

- Corer contains 2 cores, 8 cm diameter each
- Max. penetration depth about 60 cm
- number of replicate hauls: 3 per station
- Deploy at 1 m s<sup>-1</sup>
- Data needed: latitude / longitude, water depth, core length
- Lower speed when the corer approaches the sea floor to about 0.5 – 0.8 m s<sup>-1</sup> (depends on the substrate and may differ between stations)
- Weight may also be adjusted (0 to 3 pieces of lead which come with the corer)
- Place on deck very carefully, since undisturbed surface is essential

#### 12.3.5 van Veen Grab (back up to Box corer) (Figure 1 e)

- Sample surface area: 0.1 m<sup>2</sup>
- In case box corer cannot be used, replicates per station: 4-5
- Data needed: latitude / longitude, water depth, fullness of grab
- Store and handle with safety pin in place, for deployment release safety pin
- open jaw and push pinch-pin with spring in place, keep pressure on pin (other types have a little metal hook instead)
- lift grab over board with winch
- lower at 1 m s<sup>-2</sup>, slower near bottom
- pinch-pin (or metal hook) will pop out when grab reaches the bottom and wire is no longer under tension
- pulling up cable gently will close jaws, swing grab over tub or sieve
- discard grabs that are less than half full, or where the sediment overflows through the windows



*Fig. 1 Sediment / benthic sampling gears to be used during Arven etter Nansen cruises. A-B) Beam trawl, C-D) Campelen trawl (photos: B. Bluhm), E) box core (photo: R. Hjertenes), F) Gemini corer (photo S. Hess), G) van Veen Grab. (photo B. Bluhm).*



## 12.4 SAMPLING

Sampling procedures for sediment and benthic invertebrates are outlined here. Not all sampling may be conducted on all cruises. Additional sampling specific to a particular objective, requiring extensive training and/or only conducted on a single or few cruises is not listed here.

### 12.4.1 Beam trawl and Campelen trawl

**Measured parameter:**

**Method Responsible:**

**Description of parameter/Aim:**

**Methodological description:**

→ **Special requirements/Gear:** Beam and Campelen trawl

→ **Sampling depths:** Station bottom depths

→ **Chemicals used:** Formaldehyde 37%, Formaldehyde solution ~4%, buffer borax or hexamethylenetetramine, 95% Ethanol, molecular grade

### **Quantitative epibenthic megafauna**

1. Take photo of catch with sample label
2. record sediment type (rocks, shell hash, mud, etc.) if visible
3. If catch is too large to sort in its entirety, subsample for abundant taxa after mixing the catch, note subsampling factor by weighing total catch and subsample, then sort subsample (for rare and large taxa, sample 100% and note which taxa were sampled this way)

4. Sort the catch, separating all obviously different taxa, put each in a container (big or abundant specimens into buckets/tubs, small or rare taxa in trays/petri dishes)
5. Keep specimens in seawater to keep them fresh
6. Identify taxa to lowest practical taxonomic level; give descriptive names to unidentified taxa and keep them consistent throughout the cruise
7. Count and weigh by taxon (note weight unit), including macroalgae
8. Do not include empty shells and tubes in counts / weights
9. Place 2-5 individuals in 4% formaldehyde seawater solution as voucher with label (at least all taxa where the identification is not certain, better all taxa once per cruise) – under hood, with nitrile gloves on, DO NOT FREEZE
10. Do not discard catch before sampling for all other objectives is done!
11. Record data on counts, weights (with unit), sub-sampling factor, station and date on data sheet, enter data into provided data file

### **Food web samples**

1. Once trawl is sorted and counted, stable isotope samples and contaminant samples will be taken and frozen at -20 °C (compound specific isotope samples at - 80 °C)
2. pick out invertebrates and fishes from benthic sampling gear, at least 3 replicates per taxon and station of dominant / specific taxa (depending on objective)
3. If time is limited, put whole replicate specimens (clean, rinsed) in zip lock bags by taxon and label with station name and taxon
4. if time allows, dissect tissue samples (each roughly 1x1x1 cm) from 3 replicate organisms using muscle where possible (mollusks, crustaceans and such), otherwise body wall (annelids, cnidarians, ascidians, holothurians etc.), tube feet (asteroids), central disc (ophiuroid), organism pieces (sponges, bryozoans, hydroids etc.) or whole organisms (small taxa such as amphipods – take out gut where possible) – avoid guts whenever possible
5. Put tissue samples in microcentrifuge tubes / sampling vial, label on top and side with permanent marker

6. Record in sample log: Station number, date, isotope sample number (start at 1, consecutive numbers, species (or description), phylum, how many individuals, replicate number, tissue type
7. Prepare a voucher for all species collected for isotope analysis (at least 1, better several individuals in 4% formaldehyde-seawater solution with station label and number of isotope sample for cross-reference) (we do not need duplicate vouchers per species)
8. If time allows, dry tissues with open lids at 60 degrees C in drying oven for at least 24 hours. Close lids when done. Pack sample trays into ziplock bags and store in closed boxes so no additional carbon/nitrogen particles get in.
9. Work in clean area and with gloves during dissections, rinse dissection tools between species, avoid getting any additional carbon or nitrogen on the samples

### **Contaminant samples**

→ see RF2 protocol?

### **Barcoding samples**

If time is limited: For taxa from taxon list provided, place 4 specimens of same taxon in a ziplock bag and freeze at -20 °C with label

If time allows: Take picture of each of 4 specimens per species, place tissue sample (or whole individual if small enough) into separate sample vials/jars with label in ample amount of 95% molecular alcohol, shift alcohol after 24 h

#### **12.4.2 Box corer**

**Measured parameter:**

**Method Responsible:**

**Description of parameter/Aim:**

### **Methodological description:**

→ **Special requirements/Gear:** Box corer

→ **Sampling depths:** Station bottom depths

→ **Chemicals used:** Formaldehyde 37% , Formaldehyde solution ~4% ,  
buffer borax or hexamethylenetetramine

### **Algal pigments**

- Use Cut-off 60-ml plastic syringe
- Collect 3 replicates per station
- insert syringe into the surface of the box core (or grab) to a bit more than the sampling depth of 2 cm (TBD)
- pull out gently by turning such that the sediment does not get lost
- place sediment “plug” in a plastic whirl-pak / zip lock bag
- wrapped in aluminum foil
- freeze at -20°C

**Barcoding samples** → See trawl

**Food web samples** → See trawl

**Foraminifera experiments (Alve)**

Sediment meiofauna community respiration experiments will be conducted during seasonal cruises. Since only trained personnel will conduct these experiments, no protocol is provided here.

### **Quantitative macrofauna**

- 3 replicate samples, sub-sample of a 0.5 x 0.5 m box corer
- All infaunal samples will be sieved using a 500- $\mu$ m sieve (and stacked 250  $\mu$ m sieve at deep samples  $\geq$ 500 m)
- Any water remaining on the surface of the box corer should be siphoned onto a sieve, and sieve contents put into the sample jar with the rest of the sieved sample

- Push in sub-sampling device to about 20 cm
- Shovel out soft upper sediment layer (often 2-10 cm) top layer (using a small spade or spoon) and gently sieve it using low pressure
- Transfer retained animals and detritus to a sample jar using forceps and squirt bottles
- Then sieve lower layer to 15 cm with slightly more pressure
- Add buffered 4% formaldehyde-seawater solution to jars
- Never fill jar completely full with fauna/sediments - they will not preserve well
- Gently turn over sample a few times to ensure preservative fully penetrates the sample Lids should be sealed with electrical tape and stored in chemical-proof space for return to the home institute - DO NOT FREEZE

**Microbes** → Bergen group

### **Total organic carbon and nitrogen content**

Sediment samples will be collected from surface using a syringe depending on needs. During cruises where biologists take samples, of the top 0-2 cm are taken.

**pH** → RF2, Tine Rasmussen.

**Pore water content** → RF2, Tine Rasmussen

### **Respiration experiments**

Sediment community respiration (oxygen uptake) experiments will be conducted during seasonal cruises. Since only trained personnel will conduct these experiments, just a brief protocol is provided here. Incubation cores will be topped off with bottom water collected using the ship's rosette and bubbled to saturate the overlying water with oxygen. Control cores were filled with bottom water and bubbled. Cores were always kept in the cold room at 0–2 °C. All cores were sealed using tops that provided constant stirring. Oxygen concentrations will be monitored during the incubations using a

microelectrode or optode. Incubations will be terminated when 15–30% of the oxygen had been consumed (usually 30–48 h).

### **Sediment grain size**

- One sample will be collected from each box core / grab (or one per station?)
- Scrape surface 5 cm sediments with a spoon and transfer directly to a ~200mL Ziploc bag. The bag should be mostly full.
- label bag, keep frozen at -20°C

### **Sediment stable isotopes, carbon and nitrogen**

- Use Cut-off 60-ml plastic syringe
- Collect 3 replicates per station
- insert syringe into the surface of the box core (or grab) to a bit more than the sampling depth of 2 cm
- pull out gently by turning such that the sediment does not get lost
- push out core to 2cm and slice off 2cm plug
- place sediment “plug” in a plastic whirl-pak / zip lock bag
- freeze at -20°C

#### **12.4.3 Gemini corer: Meiofauna**

**Measured parameter:**

**Method Responsible:**

**Description of parameter/Aim:**

**Methodological description:**

→ **Special requirements/Gear:** Gemini corer

→ **Sampling depths:** Station bottom depths

→ **Chemicals used:** Ethanol (Rektifisert sprit, EG.nr. 200-578-6) rose Bengal.

## Method

- each core sectioned into 1 cm thick slices down to 6 cm, then 2 cm slices down to 10 cm
- each slice transferred to 180 ml Joni plastic containers add the same volume of rose Bengal stained 70% ethanol (2g/L) as sed volume (1:1) – DO NOT FREEZE
- mesh size of subsequent (post cruise) sieving: 63  $\mu$ m
- Post cruise: Forams are picked and the remaining sample is kept for metazoan meiofauna analysis
- if long enough (30-50 cm), core can be used for palaeo objective in RF1 (if not, need RF1 core)



*Fig. 2 Biological sample taking procedures. Top left) Box core sampling, top right) emptying van Veen grab into a tub for sieving, middle left) Sectioning Gemini core (and sampling container), bottom left) sorting trawl sample, bottom right) sieving macrofauna (from van Veen / box core). (Photos S. Hess, B. Bluhm).*



## 12.5 SAMPLE LABELLING

A sample labelling system was developed for the entire project and was introduced on JC1-2 in August 2018. This system includes a labelling code and provides labels on chemical and water proof paper. See labelling protocol.

## 12.6 SAMPLE PROCESSING

Lab processing notes are very brief at this point, full protocols are not provided here, but can be obtained from the responsible labs.

### 12.6.1 Quantitative community samples

**Measured parameter:**

**Method Responsible:**

**Description of parameter/Aim:**

**Methodological description:**

→ **Special requirements/Gear:**

→ **Sampling depths:**

→ **Chemicals used:** Ethanol 70%

**Microbes:** UiB, Gunnar Bratbak (to archive for time being)

- Processing for molecular analysis → see bacteria / viruses etc. protocols
- Sample storage is at UiB

**Meiofauna:** UiO, Alve (Foraminifera), UiT/Bluhm & APN /Renaud (metazoans)

- Foraminifera will be sorted from alcohol/rose Bengal samples

- Foraminifera will be identified morphologically in the home lab at UiO and enumerated
- Metazoan meiofauna samples will be archived at UiT for the time being until funding / an MS thesis is available

**Macrofauna:** Bluhm/UiT to coordinate (collaboration with IOPAS)

- Sorting and taxonomic identification is planned in collaboration with the Institute of Oceanology Polish Academy of Sciences
- Formalin-preserved samples will be transferred to 70% ethanol
- Ethanol samples will be washed and sorted to higher taxa under a stereomicroscope
- Taxa will be identified to the desired level by morphological characteristics
- Individuals will be enumerated and weight be determined
- Taxonomic names will be standardized to the World Register of Marine Species
- Sample storage to be determined (museum voucher collection at the Tromsø Museum is being discussed)

→ **Chemicals used:** Ethanol 70%

**Megafauna:** IMR, Jørgensen

- Sorting, enumerating and weighing is done onboard with fresh samples
- Formalin vouchers will be transferred to 70% ethanol
- Taxonomic identifications from ethanol-preserved samples are completed in the home lab and with the help of experts
- Data recording of counts and weights by taxon and archiving follows IMR's standard protocol
- Sample storage to be determined (museum voucher collection at the Tromsø Museum is being discussed)

→ **Chemicals used:** Ethanol 70%

### 12.6.2 Food web

**Measured parameter:**

**Method Responsible:**

**Description of Parameter/Aim:**

**Methodological description:**

→ **Special requirements/Gear:**

→ **Sampling depths:** Station bottom depths

→ **Chemicals used:** 1N HCl, possibly chloroform, methanol

IMR/Jørgensen, UiT/Bluhm, NN Postdoc IMR/UiT, Åström/ UiT

- Stable carbon and nitrogen samples will be run in replicates of n=4 per taxon and station, likely at UiO using an Isotope Ratio Mass-Spectrometer with V-PDB and atmospheric N<sub>2</sub> as standards for carbon and nitrogen, respectively
- For  $\delta^{13}\text{C}$ , tissue samples containing carbonates will be treated with 1N HCl (drop by drop) until bubbling ceases, and dried again at 60 °C for at least 24 h
- sediment samples will also be decalcified and undergo several washing steps
- Decide if Lipids will be removed or not. With 2:1 chloroform:methanol

### 12.6.3 Contaminants

**Measured parameter:**

**Method Responsible:**

**Description of parameter/aim:**

**Methodological description:**

- **Special requirements/Gear:**
- **Sampling depths:** Station bottom depths
- **Chemicals used:**

UiO, Borgå → see RF2 protocols???

#### 12.6.4 Sediment properties

**Measured parameter:**

**Method Responsible:**

**Description of parameter/aim:**

**Methodological description:**

- **Special requirements/Gear:**
- **Sampling depths:** Station bottom depths
- **Chemicals used:**

**Benthic pigments:** APN (Renaud)

Pigments from the top cm (TBD if 1, 2 or 5 cm) will be analyzed fluorometrically according to Holm-Hansen et al. (1965). In the laboratory, this sediment will be thawed and 20 mL of 100% acetone will be added. Pigments are extracted in the freezer in the dark, during which tubes will be shaken periodically. After 48 h, sediment will be centrifuged (4000 rpm for 10 min) and the super-natant will be analyzed in a Turner Designs model 10-AU (or other) fluorometer before and after acidification with 10% HCl.

→ **Chemicals used:** 10% HCl, 100% Acetone

**pH:** UiT Geology / Rasmussen – protocol in RF1

**Pore water:** UiT Geology / Rasmussen/U. Ninnemann – protocol in RF1

**Oxygen profiles:** UiO / Alve – protocol in RF1?

**TOC, TON:** UiT Geology / Forwick, NP/Husum

Sediment samples will be freeze-dried and analysed for TC/TOC, TS, TN using an elemental analyser, for major and minor elements using XRF.

→ Details see sediment grain size protocol Sediment grain size: UiT Geology/ Forwick, Husum

Samples are treated with HCl and H<sub>2</sub>O<sub>2</sub> to remove organic material and calcium carbonates. The grain size distribution is analyzed with a Beckman Coulter Particle Size analyzer LS 13320.

→ Details see sediment grain size protocol

## 12.7 TYPES OF DATA TO BE GENERATED – PARAMETER DEFINITIONS

### 12.7.1 Quantitative community samples

- a. Taxa lists from morphological taxonomic identifications (currently accepted name and taxonomic hierarchy for each taxon from World Register of Marine Species)
- b. Density/Abundance: number of individuals per unit area, by species or higher taxon (unit area may be m<sup>2</sup> for macrofauna, km<sup>2</sup> for megafauna)
- c. Biomass: weight per unit area, by species or higher taxon (unit weight may be grams wet weight, or grams / mg / µg carbon)

### 12.7.2 Process / rate measurements

- a. Sediment oxygen demand (mmol O<sub>2</sub> m<sup>-2</sup> d<sup>-1</sup>)

### 12.7.3 Food web

- a. Stable isotope values, i.e. ratios of nitrogen and carbon isotopes,  $\delta^{15}\text{N}$  (per mil),  $\delta^{13}\text{C}$  (per mil)
- b. Diet composition (benthic meiofauna) as genetic sequence data

### 12.7.4 Sediment properties

- a. Chlorophyll a (mg or  $\mu\text{g m}^{-2}$ )
- b. Phaeopigments (mg or  $\mu\text{g m}^{-2}$ )
- c. Total organic carbon (mg  $\text{m}^{-2}$  and/or %)
- d. Sediment grain size see geologist protocol (% fractions of silt, clay, sand; modal distribution)
- e. Other sediment properties in geology protocols

## 12.8 SEDIMENT EXTRACTION FOR TRACE ELEMENTS

**Measured parameter:** Trace elements from sediments

**Method Responsible:** Murat Ardelan (NTNU, [murat.v.ardelan@ntnu.no](mailto:murat.v.ardelan@ntnu.no))

**Description of parameter/Aim:** Quantification of the trace element distribution and speciation in the sediment, through a four steps sequential extraction.

**Methodological description:**

→ **Special requirements/gear:** None. Samples can be collected from Box corer or Gravity corer

→ **Sampling depths:** Station bottom depth

→ **Chemicals used:**

**Material:**

- Plastic spatula
- Acid washed PE sampling tubes (15ml)

Method:

- Depending on the available instrument samples might be collected for only surface sediment or different layers for a sediment depth profile.
- From each layer available, collect an amount of ~0.5 - 1 grams of sediment with the spatula
- Samples are collected in Acid washed PE tubes and stored frozen (-20 °C) until analysis.
- This is carried out in to obtain the following fractions:

**Sequential Extraction:**

- 1) Exchangeable, Acid Soluble
- 2) Easily Reducible
- 3) Oxidizable
- 4) Residual

## 12.9 DARK DIC UPTAKE IN SEDIMENTS

**Measured parameter:** Dark DIC uptake in sediments

**Method Responsible:** Tobias Vornahme (UiT, tobias.vornahme@uit.no), Rolf Gradinger (rolf.gradinger@uit.no)

**Description of parameter/Aim:** Estimation of dark DIC (Dissolved Inorganic Carbon) in sediments.

**Methodological description:**

- **Special requirements/gear:** Isotope lab
- **Sampling depths:** Station bottom depth
- **Chemicals used:** 4% Formaldehyde, 1mCi/ml <sup>14</sup>C-bicarbonate

## Method:

- From the box cores 10ml surface sediment is diluted with 10ml filtered seawater and mixed into a slurry.
- The slurry is transferred into 2ml tubes for the uptake experiments and into 3 x 1.5ml tubes for later determination of the dry weight and normalization of the uptake rates.
- 5 tubes are filled with 1ml of the slurry using a cut off 1ml pipette tip.
- 2 of the tubes are killed immediately with 1ml 4% Formaldehyde in filtered seawater. All tubes are then enriched with 4ul 1mCi/ml <sup>14</sup>C-bicarbonate.
- A second set of 5 tubes is treated in the same way with addition of 50ul saturated nitrification inhibitor solution.
- The tubes are incubated for 24h in the dark at in situ temperatures and killed with 1ml 4% Formaldehyde in filtered seawater.
- The samples will be processed as described by Molari et al. (2013).
- Conversion factors determined from biomass experiments in the central Arctic ocean (Molar et al. in prep) will be applied to calculate bacterial and archaeal biomass production.
- Nitrification will be determined as the difference between the treatments with and without nitrification inhibitor.

## Literature:

- Molari, M., Manini, E., & Dell'Anno, A. (2013). Dark inorganic carbon fixation sustains the functioning of benthic deep-sea ecosystems. *Global Biogeochemical Cycles*, 27(1), 212-221.



## 13 Fish

Fiske prøvetaking er mest omfattende prøvetaking på toktet og de fleste arbeidspakker ønsker å ta prøver av ulike typer fisk til ulike formål. Derfor er det viktig å følge prosedyrer for håndtering av fangsten:

### 13.1 FØR TOKT

#### 13.1.1 Tester og programvare o.l.

Man må sørge for å ha med siste versjon av S2D.

#### 13.1.2 Oppsett av prøvetaking og FishMeter

Det blir mest sannsynlig felles konfigurasjonsfiler til FishMeteret (felles for pelagisk og bunn). Disse filene er så godt som mulig tilpasset individprøvetakingen som skal gjøres på toktet. Tilpassinger må man regne med. Vær obs på at vektinnstillingene kan være feil. Noter vektinnstillinger fra eksisterende oppsett før import av ny konfig fil.

#### 13.1.3 Serienummer og toktnummer til fartøyet

Fartøy	Serienummer	Toktnummer
--------	-------------	------------

#### 13.1.4 Stasjonsdata\_trål koding

Koder for bunntål i forhold til om de er rigget med tromsørigging eller ikke:

- 3270: Campelen, Rockhopper gear.
- 3271: Campelen, Rockhopper gear, strapping.
- 3292: Campelen, Rockhopper gear, Tromsørigging.
- 3293: Campelen, Rockhopper gear, strapping, Tromsørigging.
- 3514: Harstadtrål 16 x 16 famner, med blåser

#### 13.1.5 Anbefalt ekstrautstyr til bruk under 0-gruppeundersøkelser

I tillegg til vanlig prøvetakingsutstyr bør en også ta med følgende:

- Dørslag: 1-2 stk.
- Vannfaste/laminerte millimeter papirremser: flere
- Petriskåler av plast eller glass: 8-10 stk.

- Ekstra lengdemålingsbrett (cm/mm): 1 stk.
- Pipetter: 10-20 stk.
- Pinsetter (til felles bruk, hvis ikke toktdeltakere ikke har egne)
- Små plastposer for å fryse ned interessante prøver.

## 13.2 UNDER TOKT

Ved toktstart bør det utnevnes en vaktleder som kan ta oppgaven med å kommunisere mellom vaktene og med toktleder. Det er viktig at vaktene jobber likt gjennom hele toktet.

### 13.2.1 Merking av prøver

For merking av prøver skal serienummer brukes, ikke stasjonsnummer. Stasjonsnummer kan være overlappende mellom båtene.

Husk at årstall må være med på merkingen.

### 13.2.2 Datahåndtering

#### 13.2.2.1 Testing av data

Data må testes og rettes kontinuerlig. Det er viktig at vaktleder tar ansvar for at alle data blir lagt inn riktig og testet.

#### 13.2.2.2 Kort om nye FMD import

Vi har en ny mulighet til å importere data til Editor direkte fra FMD. Dette gir noen endringer og muligheter:

- Ukjente arter "SPECIES\_XX" og ikke gyldige artsnavn blir lagt inn som "Ukjent", samtidig som navnet som er brukt blir lagt inn i kommentarfeltet. Dette er fordi det ikke er mulig å legge inn ugyldige artsnavn direkte i Editor. Vær obs på at art="Ukjent" vil gjøre at man ikke får feil ved dagens testprogram.
- Nå blir alle måleverdier registrert. Dvs. at all fisk under 50 cm, blir lagt inn i 0.5 cm oppløsning, mens all fisk over 50 cm, blir lagt inn i 1 cm oppløsning. Dette gjør innstillingen vi tidligere gjorde i 5mmgr.int filen unødvendig.
- Det er nå mulig å bruke MM (millimeter) funksjonen direkte fra målebrettet.

- I tillegg til at man kan bruke MM på brettet vil også dagens målinger (i cm) av 0-gruppe fisk bli konvertert til millimeter i de tilfellene der artsnavnet begynner med "0-GR"
- Summering av individvekter til prøvevekt kan velges ved import av FMD fil.

### 13.3 PRØVETAKING TIL ULIKE BEHOV OG STASJONS TYPER

Prosess stasjoner hvor alle fiskearter sorteres, identifiseres, måles og tas biologiske prøver av (otolitter, mager, isotoper osv)

På forhånd satt stasjoner langs transekter beregnes også som standard stasjoner. På disse stasjonene hele fangsten sorteres, arts identifiseres, måles og tas biologiske prøver av (otolitter, mager, isotoper osv)

Tilleggsstasjoner ble tatt etter behov, for eksempel, for å ta genetiske prøver.

Prøver til genetiske studier tas på tilleggsstasjoner utenfor «Prosess stasjoner» og behandles etter spesielt manual, Annex1). På disse stasjonene, polartorsk, torsk og lodde sorteres ut først av fangsten og behandles separat (Annex 1). Husk å veie total fangst og noter total antall av genetisk prøve, denne skal legges sammen (per art) til resten av fangsten for å få total vekt og antall (per art). Resten av fangsten opparbeides på en enklere måte. 1) total vekt av sorterte fisk veies per art og total vekt noteres. Lengdemål 30 stk av hver fiskeart og noter total vekt for lengdemålt prøven. Vekt og antall fisk i lengdemålt prøven brukes til å beregne total antall på stasjonen.

Prøver til isotop kan tas på tilleggsstasjoner eller «Prosess stasjoner» og behandles etter spesielt manual, Annex 2). På disse stasjonene, polartorsk, torsk og lodde sorteres ut først av fangsten og behandles separat (Annex 2). Husk å veie total fangst og noter total antall av genetisk prøve, denne skal legges sammen (per art) til resten av fangsten for å få total vekt og antall (per art). Resten av fangsten opparbeides på en enklere måte. 1) total vekt av sorterte fisk veies per art og total vekt noteres. Lengdemål 30 stk av hver fiskeart og noter total vekt for lengdemålt prøven. Vekt og antall fisk i lengdemålt prøven brukes til å beregne total antall på stasjonen.

Food web studier kan tas på standard eller «Prosess stasjoner» og behandles etter standard prøvetakings beskrevet nede. Hvis både mager og isotoper tas da burde man velge process stasjoner, hvor fiske biomas og mengde ble beregnet.

### 13.3.1 Prøvebehandling og sortering på dekk

Når trålen, spesielt pelagisk trål, kommer opp og fangsten kommer inn, er det veldig viktig å riste trålen og trålposen for å få med seg flest mulig individ i samplingen for riktig indeksberegning, og unngå at gammel fisk forurenses senere prøver. Vanligvis er problemet med fisk i trålmaskene størst på stasjoner med mye fiskeyngel. Det er en fordel å ta ut maneter og større fisk (som f. eks. rognkjeks) slik at det blir lettere å bearbeide resten av pelagisk fangst. Manetene bør også renses grundig slik at det ikke henger 0-gruppefisk igjen i disse. Macroplankton (krill og amfipoder) tas ut for videre opparbeidelse (se i plankton manual) av plankton eksperter (hvis det er kapasitet) eller fiske eksperter.

All 0-gruppefisk som havner på dekk skal samles og veies per art. Siden denne delen av fangsten normalt har dårlig tilstand skal den samles og bearbeides adskilt fra fangsten som ligger i trålposen. Hvis det er vanskelig å samle alt gis omtrentlig vekt.

### 13.3.2 Prøvebehandling og sortering i lab

Hele fangsten sorteres per art. hver art opparbeides separat (se Tabel 1). Når total vekt per art beregnes, skal en summere vekten fra den delen av fangsten som var i trålposen og vekten fra den delen av fangsten som ble plukket fra dekk, og deretter skal totalt antall beregnes ut fra total vekt.

Dersom hovedmengden av 0-gruppefiskefangsten kommer fra trålposen og bare en liten del kommer fra maskene og dekk, er det tillatt å blande delene godt før man begynner sortering.

Fangst fra pelagisk trålposen opparbeides slik:

hele prøven samles på sorteringsbordet, og filtreres (siles) deretter *en enkelt gang* for å fjerne overskuddsvann i blandingen på en standardisert måte.

fiskeyngel fra trålposen sorteres nøye (bruk beskrivelser i «MANUAL FOR IDENTIFISERING AV 0-GRUPPE FISK "ØKOSYSTEMTOKT I BARENTSHAVET» for å skille grupper) fiskeyngel som stammer fra dekk og trålmasker sorteres på samme måte.

#### 13.3.2.1 Subsampling

Dersom fangsten er så stor at det ikke er hensiktsmessig å sortere alt, skal det tas en subsample som er håndterlig men også representativ (for eksempel 1/4 eller 1/8 av totalfangst). Både totalblanding og subsample veies og vekt noteres. Subsample sorteres og opparbeides som beskrevet ovenfor.

For å beregne riktig vekt og antall per art gjøres følgende: Bruk totalvekt for 0-gruppeblandingen (f. eks. 8 kg eller 8000 gram) og totalvekt for subsample (f. eks. 1 kg eller 1000 gram). Omregningsfaktoren blir i dette tilfellet:  $8000/1000 = 8$

Hver utsortert fiskeart fra subsample multipliseres så med denne faktoren for å få riktig total vekt og antall.

Selv om subsamling utføres, skal hele prøven gjennomgås for å få med eventuelle arter som ikke var representert i subsample. Dette gjøres også for å få et mest mulig riktig antall på artene som er sjeldne i subsampelet (disse skal altså *ikke* multipliseres med faktor som beskrevet over).

#### 13.3.3 Lengdeprøvetaking

Etter at fangsten er sortert og veid i henhold til beskrevet prosedyre, skal det tas en representativ lengdeprøve av alle arter. Er fangsten av en art < 30 individer skal alle individer lengdemåles. Er fangsten  $\geq 30$  individer, skal 30 individer lengdemåles. Resten telles og veies. All 0-gruppefisk måles i mm. Til lengdeprøven velges det ut en representativ prøve av fisk som ikke er skadet, helst fra den delen av fangsten som kommer fra trålposen.

#### 13.3.4 Målarter og andre arter

Begrepet målarter er ikke helt presist, men vi mener i hovedsak de kommersielle fiskeartene som beskrevet i Tabell 1.

For alle fiskeartene i tabellen under skal det minst tas: **Lengde, vekt, otolitt, kjønn og stadie**. For de andre tas det et representativt lengdemål. For skatene/havmus legges også kjønn inn.

*Tab. 1 Individprøver*

Art (prøvetype)	Lengde gruppe	Ant	Min lengde	Individ prøver <sup>1</sup>	Biologiske prøver <sup>2</sup>	Kommentar
Snabeluer (21) Sebastes mentella	5	1	20		Mager	Vekt og otolitt tas også av mindre fisk.
Vanlig uer (20) Sebastes norvegicus	Alle	Alle	Alle		Mager	Vekt og otolitt tas av mindre fisk
Torsk (21) Gadus morhua	5	1	20	Levervekt > 40 cm Gonadevekt > 40 cm for hofisk	Mage	Vekt, mage og otolitt tas også av mindre fisk
Blåkveite <sup>3</sup> (21) Reinhardtius hippoglossoides	5	1	Alle	Spesialstadie	Mager	Vær obs på ny rutine i forhold til kjønn/delpr.

<sup>1</sup> Individregistreringer utover listen som gjelder alle målantene.

<sup>2</sup> Prøver som skal lagres og tas i land

<sup>2</sup> Blåkveite håndteres spesielt i forhold til kjønn og delprøver. Se eget punkt på dette

Lodde (20, 23 og 34) Mallotus villosus		100	0		Mager	
Hyse (21) Melanogrammus aeglefinnus	5	1	20	Levervekt > 30 cm Gonadevekt > 30 cm for hofisk	Mager	Vekt og otolitt tas også av mindre fisk.
Polartorsk (20, 23 og 34) Boreogadus saida		96	0		Mager	
Sild (23) Clupea harengus		30	0		Mager	Skjell + otolitter
Kolmule (21) Micromesistius poutassou	5	2	10		Mager	
Ikke-kommersiell fisk (20)	Alle	20			Mager	Lengde og vekt

### 13.3.5 Maneter, pelagiske amfipoder og krill

Sortes ut og registreres med PRØVETYPE = 90 (evertebrater).

Planktonprøvetakere er ansvarlige for artsidentifisering av krill, mens fiskeprøvetakere er ansvarlige for å registrere det i S2D.

Ca 50 gram skal artsidentifiseres og regnes om til total vekt for de ulike artene (ca 4 arter). Navn på disse legges inn i Editor.

### *Maneter*

Alle maneter fra trålhal sorteres ut, artsidentifiseres og veies av fiskeprøvetakere. Hvis det er mulig angis antall.

- Glassmanet (*Aurelia aurita*): Sirkelrund skive med mange korte tentakler. Vanlig april-september
- Brennmanet (*Cyanea capillata*): Diameter opp til 2 m, vanligvis mindre. Skiven delt inn i 8 lober, med 8 klynger. Fargen kan variere fra dyp rød-orange-gulhvit. Vanlig april-september

#### 13.3.6 Koding av 0-gruppeprøver

Som referert tidligere i «HÅNDBOK FOR PRØTEKAKING AV FISK OG KREPSDYR» defineres 0-gruppetrålning under redskapskode **3514: Harstadtrål 16 x 16 famner, med blåser**. I tabellen finnes også redskapskode 3513: Harstadtrål 16 x 16 famner, uten blåser. Disse to redskapskodene må ikke forveksles. Kun **3514** blir brukt på de faste 0-gruppestasjonene. Redskapskode 3513 blir for eksempel brukt ved tråling på registrering med harstadtrål i dypet.

Tidligere ble antall dybdesteg trålen har vært gjennom ført inn i rubrikken FISKEDYP MAKS. Fra 2017 kom det eget felt «Antall fiskedyp» hvor antall dybdesteg trålen har vært gjennom skal føres. Se tabellen nedenfor for komplett liste, eller hele listen i «Håndboken».

Det er viktig at alle trålstasjonene kodes riktig. Prøvetakere må følge med og sjekke at informasjonen som kommer fra broen er riktig. Gi beskjed/endre det som er feilpunchet. Gi i tillegg beskjed til instrumentpersonell slik at endringer rettes på alle nivå og ikke kommer tilbake ved neste import av data.

De mest vanlige koder for «Antall fiskedyp» og totaltid er listet nedenfor:

Tråling i overflaten 1 (distanse: 0.5 nm; total tid: 10 minutter)



Tråling i 0 og 20 meter 2 (distanse: 1.0 nm; total tid: 20 minutter)

**Tråling i 0, 20 og 40 meter 3 (distanse: 1.5 nm; total tid: 30 minutter)**

Tråling i 0, 20, 40 og 60 meter 4 (distanse: 2.0 nm; total tid: 40 minutter)

Tråling i 0, 20, 40, 60 og 80 meter 5 (distanse: 2.5 nm; total tid: 50 minutter)

### 13.3.7 Boss/Søppel

Registrering av søppel er basert på OSPAR<sup>4</sup> sin guide for søppelregistrering. De har laget en fotoguide, som beskriver hele 120 forskjellige søppeltyper. Manualen er for øvrig laget for kartlegging av søppel i strandsonen. Vi har derfor prøvd å forenkle og plukke ut aktuelle kategorier, som passer for oss og åpne havområder. Disse skal registreres direkte i S2D.

**I S2D:**

**ART = FREMMEDLEGEM** ("Fremmedlegeme" er en "art" som ligger i testprogrammene og skal ikke gi feilmeldinger). **VEKT** og **ANTALL** skal registreres på best mulig måte.

For å skille de forskjellige søppeltypene fra hverandre, brukes **PRØVETYPE**:

**60 = METALL**

**61 = GLASS**

**62 = KERAMIKK**

**63 = PAPIR**

**64 = TRE (maskinbehandlet)**

**65 = TAU/LINE**

**66 = RESTER ETTER GARN**

---

<sup>4</sup> Oslo and Paris Conventions for the protection of the marine environment of the North-East Atlantic

67 = BLÅSER/KULER (hele eller rester)

68 = ANNEN PLAST

69 = ANNET

Taurester og annet, som man antar kommer fra eget fartøy skal også tas med i registreringen. Organisk avfall (matrester o.l.) skal normalt ikke tas med som søppel.

Kodene for PRØVETYPE ligger ikke inne i testprogrammene og kan medføre uriktige feilmeldinger.

For de som er interessert finnes OSPAR dokumentasjonen på fellesområdet (se kap 13.5)

### 13.3.8 Overføring fra målebrett til Sea2Data

Etter at vi begynte å importere data direkte fra målebrettet (FMD-filformat) har det vært behov for litt omstillinger hos prøvetakere og endringer i innlesingsrutiner som er viktig å huske.

For å holde 0-gruppe målinger adskilt fra vanlige målinger anbefales det å ta noen forholdsregler før man begynner å registrere data i målebrettet;

Lengdeenhet må endres fra cm (centimeter) til mm (millimeter) på målebrettet for å få inn målingene i riktig enhet til Sea2Data. Husk at denne funksjonen **må slås PÅ** før en begynner å trykke inn lengder og **må slås AV** når en er ferdig med målene.

Det vanlige er at en prøvetaker måler fra et manuelt mm-brett mens en annen prøvetaker slår tallet inn på elektronisk Brett i hele millimeter.

I tillegg er det også lurt å bruke funksjonen **delprøve** som en ekstra sikkerhet for å holde adskilt yngel fra voksne individer. Bruk gjerne et **delprøvenummer** høyere enn normalt, for eksempel **delprøve 6**: Funksjon + **LOT** + **6** + **ENTER**. Men husk at også denne funksjonen **må slås PÅ** før man begynner å trykke inn

lengder og **må slås AV** når man er ferdig med prøven. For å få delprøve tilbake til delprøve 1: Funksjon + **LOT + 1 + ENTER**.

Tidligere brukte vi noen oppkonstruerte artsnavn som begynte med "**0-GR**" for skille yngel fra voksne individer. Dette er ikke nødvendig lenger. Vi har gått fra denne løsningen siden det var umulig å ha så mange "**0-GR**"-arter i konfigurasjonen.

#### 13.3.8.1 Huskeliste

- Håkjerring skal måles med målebånd og legges inn i S2D, ikke bare fotograferes...
- Det skal som hovedregel brukes entydige **norske navn** på artene.
- Det skal testes med begge testprogram (bunn/pelag) etter hver stasjon
- Evertebrater (alt utenom fisk, dypvannsreke, snøkrabbe og kongekrabbe (?)) skal kodes med PRØVETYPE = 90.
- 0 - gruppe skal kodes med GRUPPE = 10, lengdemåles kun 30 individer. Om man har blanding av 0 - gruppe og eldre fisk, SKAL disse deles opp i flere delprøver. Blanding av kun LODDE, SILD, TORSK, HYSE skal tas otolittene til å finne grensen mellom 0 og 1 år.
- For å kvalitetssikre koding av 0 - gruppe (GRUPPE = 10), så bør man ta otolitt av noen individer for å sjekke at det faktisk er 0 - gruppe fisk i den aktuelle størrelsesklassen (f.eks uer, hyse osv).
- En del arter måles på en spesiell måte, f.eks isgalt og havmus.
- Utplukkprøver (for eksempel utplukk av yngel som skal brukes for å finne grensen mellom 0 og 1 år) skal kodes med GRUPPE = 49.
- På pelagisk fisk skal det ikke brukes gruppebetegnelse (f.eks GRUPPE = 13) når en får en prøve med blanding (1, 2 år gammel fisk). Disse skal splittes på flere delprøver.
- Dypvannsreker veies separert fra andre reker
- Det er viktig at man koder 0-gruppe fisk (torsk, hyse) man får i bunntål. 0-gruppe fisk fra bunntål kan enten være tatt når trålen har vært på vei ned eller på vei opp. Alternativt er at fisken faktisk har bunnslått seg.

## 13.4 ETTER TOKT

### 13.4.1 Avlevering av data

Data synkroniseres via S2D. Viktig at toktleder følger opp dette.

Liste over frysevarer leges ved med forsendelse og i toktkatalogen. Liste burde inneholde informasjon ser.nr, art, del prøve, type av prøve (otolitt, mage, genetikk, sjeldne arter)

Toktlederen er ansvarlig for å kopiere katalogen med alle data, unntatt akustikk

## 13.5 NYTTIGE ADRESSER

Nyttige adresser

- Testprogrammer og artslister: \\artemis\prosjekt\pelag\spd315
- Håndbok for prøvetaking av fisk og krepsdyr: \\delphi\pc\_prog\Tokt\_og\_Feltressurser\Dokumenter\Håndbok (h:\Tokt\_og\_Feltressurser\Dokumenter\Håndbok\)
- SPD gruppens side på intranett: <http://hinnsiden.imr.no/ressurser/spd>
- H. Stockhausens SPD nytteprog: [http://hinnsiden.imr.no/ressurser/spd\\_nytteprogram](http://hinnsiden.imr.no/ressurser/spd_nytteprogram)
- <https://www.hi.no/hi/tokt/havforskningsinstituttets-ulike-tokt/okosystemtoktet-i-barentshavet>

## 13.6 SAMPLING FOR POLAR COD, ATLANTIC COD AND CAPELIN BY DENERSAL AND PELAGIC TRAWL

**Measured parameter:** Biological sampling for polar cod, atlantic cod and capelin

**Method Responsible:** Ireen Vieweg (UiT, [ivi006@uit.no](mailto:ivi006@uit.no)), Siv Hoff (UiO, [s.n.k.hoff@ibv.uio.no](mailto:s.n.k.hoff@ibv.uio.no)), Sissel Jentoft (UiO, [sissel.jentoft@ibv.uio.no](mailto:sissel.jentoft@ibv.uio.no)) and Kim Præbel (UiT, [kim.praebel@uit.no](mailto:kim.praebel@uit.no))

Description of parameter/Aim:

Methodological description:

→ Special requirements/gear:

- Demersal trawl conducted with Campelen 1800# bottom trawl
- Pelagic trawl conducted with Harstad type mid water trawl
- 2x 500 L seawater tanks on deck supplied with constant running seawater
- Several 50 L buckets

→ Sampling depths:

- Demersal trawl at sea floor (approx. 200 m depth) in sound scattering layer on shelf break
- Pelagic trawl in sound scattering layer in the mesopelagic
- Demersal and pelagic trawl should be conducted on all possible stations (at least one station south of polar front, two at the central shelf and one at the northern shelf)

→ Chemicals used:

Method:

*Demersal trawl and pelagic trawl*

- Demersal trawl for 5- 15 min (trawl time depends on intensity of backscatter in sound scattering layer, checked on echosounder) at a towing speed of 2.2 – 3.4 knots
- Demersal trawl should be brought up slowly to avoid barotrauma in fish.
- Pelagic trawl towed for 45 minutes at a towing speed of 2.2 – 3.4 knots (depending on intensity of backscatter in sound scattering layer, checked on echosounder)
- Empty trawl on deck in prefilled black buckets.

- Quickly transfer desired fish (polar cod, Atlantic cod, capelin and other relevant species if we see that we can get nice sample size(s) of these) to seawater tanks using small nets.
- Quick course sorting if necessary place “bycatch” (fish that is not required for our sampling) in additional buckets for fish community assessment
- Assess possibility of taking a second trawl to have enough fish samples for all participants
- Fish are kept in tank covered with a lid on deck and sampled successively during the next 24 hours after the trawl

Fish will be sampled, see protocol “fish dissection”.

### 13.7 BIOLOGICAL SAMPLES FROM POLAR COD, ATLANTIC COD AND CAPELIN – BASELINE STUDY & GENOMIC STUDY

#### Measured parameter:

**Method Responsible:** Ireen Vieweg (UiT, ivi006@uit.no), Siv Hoff (UiO, s.n.k.hoff@ibv.uio.no), Sissel Jentoft (UiO, sissel.jentoft@ibv.uio.no) and Kim Præbel (UiT, kim.praebel@uit.no)

#### Description of parameter/Aim:

- Fork length: the length of a fish measured from the most anterior part of the head to the deepest point of the notch in the tail fin.
- Total length: the length of a fish measured from the most anterior part of the head to the tip/end of the tail fin.
- Total weight: wet weight of fish in gram before dissection starts
- Presence of ectoparasites: visual check of the presence of ectoparasites on the fins or gills of the fish, record the number of ectoparasites,
- Sex: is the fish male or female or immature (no gonads present in the fish)
- Liver weight: weight of the liver
- Gonad weight: weight of the gonad
- Maturation stage: On the basis of shape, size, color of the gonads and other morphological features, at least six maturity stages can be recognized

- Somatic weight: weight of the fish when all inner organs are removed from the fish
- Phenotype measurements: All parameters described above, i.e. fork length, total weight and length, presence of ectoparasites, sex, liver weight, gonad weight, maturation stage and somatic weight.

### Methodological description:

#### → Special requirements:

- Dissection should start right after the trawl comes up to minimize stress/degradation of DNA/RNA
- All sampling has to be done on ice and in pre-chilled tubes/solutions
- Ireen Vieweg aims for a dissection of 40 polar cod in order to allow a balanced sex ratio at each station (P3, P4, and P5)
- Sissel Jentoft aim for a dissection of 40 of each species (i.e. polar cod, capelin and Atlantic cod) in order to allow a balanced sex ratio at each station (P1, P2, P3, P4, and P5)

#### → Sampling depths: See protocol "fish trawl"

#### → Chemicals used:

### Method

- Anesthetize fish in Finquel<sup>®</sup> bath (0.5 g/ L seawater).
- Collect blood sample from caudal vein -> transferred into proper vials with SET-buffer (5-10 ml) (protocol of buffer by Sissel Jentoft) for long term storage on -80°C.
- Centrifuge blood for 30 minutes at 4°C
- Record fork and total length, total weight, presence of ectoparasites
- Remove otoliths, place them in envelopes (for ageing later on)
- Open the fish -> record sex, maturation stage, liver and gonad weight as well as somatic weight

### Sampling priority list (for each station):

Priority after catch	Application					N	Notes
	RNAseq – full set (Sissel)	RNAseq – reduced set (Sissel)	DNA – Genomics (Sissel)	Phenotype (Sissel)	Calorimetry, Lipid analyses (Ireen, Geir)		
1	+		+	+		8	
2		+	+	+	+	32 (42)	total 40 for genomics (total 40 for Ireen)

#### RNAseq full set

Fish number 1 – 8 : RNAseq – samples (Sissel), important to sample as soon as possible after death place in 15 ml cryovials with RNALater:

- Liver
- Spleen
- Gonad

#### RNAseq reduced set

Fish number 9 – 40 : RNAseq – samples (Sissel), important to sample as soon as possible after death place in 15 ml cryovials with RNALater:

- Spleen\*

\*NB NB: For capelin we will instead of spleen sample liver as standard RNA sample for specimen 9-40 but will sample spleen for specimen 1-8 in addition to liver.

#### DNAseq sampling set

Fish number 1 – 40: Muscle/skin + spleen\*, place in 15 ml cryovials with 96% ethanol



\*For polar cod we will sample gills instead as an additional DNAseq sample due to small size of the spleen

### Isotope measurement

Fish number 1 – 8: Muscle tissue will be collected for stable isotope measurements

### Samples for DNA/genomics, calorimetry & lipid analyses

Fish 1 – 8: DNA-genomic samples (Sissel) + muscle (stable isotope measurement) (-20C)

Fish number 9 – 40: combination of DNA-genomics samples (Sissel), calorimetry (Geir) & lipid samples (Ireen)

- Muscle/skin\* in 96% ethanol (15 ml cryovials), aluminium-foil (-80C) and crytube (-20C)
- Spleen\* in 96% ethanol (15 ml cryovials)
- Stomach in 70% ethanol (Dramsglass), add paper-label
- Gonads in histosette (4 % neutral-buffered formalin), aluminium-foil (-80C) and crytube (-20C)
- Liver in aluminium-foil (-80C) and crytube (-20C)
- Brain in aluminium-foil (-80C)
  - Record somatic weight
- Record time throughout the dissection in order to know for how long the fish have been in the tank after the trawl came up

### **Sample storage/ Shipment address**

#### Blood samples -80C

Shipment to UiO: fish samples 1-8

Shipment to UiT: fish samples 9-50

#### RNAseq samples RNAlater( fish number 1-40)

stored at +4C for 24h before placed at -80C for long term storage

Shipment to UiO

DNA/genomic samples 96% ethanol (muscle & spleen of fish number 1-40)

stored at +4C for 24h before placed at -20C

Shipment to UiO

Stable isotope muscle samples (fish samples 1-8)

Stored at -20C

Shipment to UiO

Calorimetry samples -20C (gonad, liver, muscle of fish number 9 - 50)

Shipment to UiT/ NPI

Lipid analyses -80C (gonad, liver, muscle, brain of fish number 9 - 50)

Shipment to UiT

Stomach analyses in 70% ethanol at room temperature(fish number 9 - 50)

Shipment to UiT

Maturation analyses in 4% neutral-buffered Formalin (gonad of fish number 9 - 50)

Shipment to UiT

Age determination on otoliths at room temperature

Shipment of all samples to UiO

## 14 Marine mammals

Marine mammals related research, while part of the Nansen Legacy, is not a part of the RV Kronprins Håkon cruises. For further information on ongoing research contact:

**Method responsible:** Martin Biuw (IMR, [martin.biuw@hi.no](mailto:martin.biuw@hi.no)), Kit Kovacs, (NPI, [kit.kovacs@npolar.no](mailto:kit.kovacs@npolar.no)), Christian Lydersen (NPI, [Christian.lydersen@npolar.no](mailto:Christian.lydersen@npolar.no)), Tore Haug (IMR, [tore.haug@hi.no](mailto:tore.haug@hi.no))

## 15 Ecotoxicological samples

**Measured parameter:** Several parameters are sampled for ecotoxicological examination

**Method responsible:** Katrine Borgå (UiO, katrine.borga@ibv.uio.no), Julia Giebichenstein (julia.giebichenstein@ibv.uio.no), Robynne Nowicki (robynno@unis.no)

**Parameter description:** Collection of meso- and (low priority for II) - macrozooplankton, benthos and fish for stable isotopes, fatty acids, carbohydrates, protein and energy content during the Nansen Legacy biology seasonal process cruises. The taxa sampled will be the same for Aim I and Aim II, and data will be shared when overlapping parameters are analysed.

**Aim I:** Investigate seasonal food web biomagnification of contaminants in the present climate conditions compared to 2 decades earlier. Samples will be taken of water, zooplankton, fish (and benthos) for pollutants, stable isotopes and Hg. For future cruises: birds and mammals if possible to include logistically.

**Aim II:** Investigate seasonal and spatial patterns of energetic level and contaminants (organics and Hg) of main species at different trophic level in benthic and pelagic food chains.

### IMPORTANT:

- **NOTE: very important to avoid cross-contamination during handling.**
- Samples stored in -20C freezer.
- We will also sample opportunistically for microplastics screening, unless this is already part of the HI/NP sampling plans.
- Focus will be on the process stations which cover different areas

## 15.1 AIMS AND METHOD

### Aim 2.2.1

Investigate seasonal food web biomagnification of contaminants in the present climate conditions compared to 2 decades earlier. Samples will be taken of water, zooplankton, fish (and benthos) for pollutants, stable isotopes and Hg. For future cruises: birds and mammals if possible to include logistically.

### Aim 2.2.5

Investigate seasonal and spatial patterns of energetic level and contaminants (organics and Hg) of main species at different trophic level in benthic and pelagic food chains

### Methods

Collection of meso and (low priority for 2.2.5) -macrozooplankton, benthos and fish for stable isotopes, fatty acids, carbohydrates, protein and energy content during the Nansen Legacy biology seasonal process cruises. The taxa sampled will be the same for 2.2.1 & 2.2.5, and data will be shared when overlapping parameters are analysed.

NB: very important to avoid cross-contamination during handling.

Samples stored in -20C freezer.

We will also sample opportunistically for microplastics screening, unless this is already part of the HI/NP sampling plans.

Focus will be on the process stations which cover different areas

#### 15.1.1 Water sampling

UiO in situ water sampler (Only 2.2.1)

Deploy water sampler for 3-4 hours to filter water (1-4 L/min). The water sampler should be placed upstream of the ship, attached to a buoy or to the ship with wire.

### 15.1.2 Zooplankton sampling

Zooplankton samples should be sampled from the entire water column.

- Macrozooplankton trawl (open water): opening area 38 m<sup>2</sup> mouth, 3 mm mesh size.
- Macrozooplankton ring net (in ice): opening area 2.01 m<sup>2</sup>, 7 m long net bag with 1.55 mm or 4 mm mesh size.
- WP2 180 µm (opening 0.25m<sup>2</sup>) (NP/UiT) will be used for sampling mesozooplankton (only if time permits)
- WP3 1000 µm (opening 1m<sup>2</sup> (NP) will be used for sample larger mesozooplankton ((only if time permits))
- Specification regarding the deployment of the different nets can be found in “Zooplankton sampling protocol AeN RF3”

We need information about mesozooplankton and macrozooplankton community composition, obtained in RF3.

### 15.1.3 Benthic sampling

Bivalves and amphipods, if in areas where this is relevant for the trophic flow to seabirds. This should be sampled with triangular scrape or other type of scrape?

Fish sampling – Individual and tissue sampling

Fish should be sampled with a pelagic trawl. The target species is polar cod (*Boreogadus saida*), capelin (*Mallotus villosus*) and Atlantic cod (*Gadus morhua*). If other fish species (that can form seabird prey) are abundant, then

these should be considered as well. Samples should be taken of muscle and liver for different size group of the selected species. Biometrics, such as fork length, whole fish weight, liver weight, age (otoliths), sex, maturation, reproductive stage should be recorded.

Stomachs samples should be sampled for diet and microplastics analyses.

We need information about fish community composition as background information, obtained in RF3.

### **Sample treatment**

Sorting of zooplankton samples should be done as soon as possible after sampling. If there is delay between sampling and sorting, the samples should be diluted with in situ sea water and stored in 50L buckets in a cold room. Keep the samples cold while sorting by use of cold packs or ice. Zooplankton should be sorted into species level if possible and larger macrozooplankton should be grouped into length groups (see table below). Samples can be stored in cryo vials, aluminum foil or zip-bags depending on the size of the sample. All samples should be stored at -20°C except for fatty acid samples that should be stored at -80°C (the other samples could also be stored at -80°C).

### **Organic pollutants (5-10 g):**

Only for RF 2.2.1

### **Stable isotopes (0.5 g) and Hg (0.5 g):**

Mesozooplankton and small macrozooplankton samples should be stored in small cryo vials. Larger macrozooplankton, benthos and fish liver and muscle samples should be stored in aluminum foil into plastic bags (dorsal muscle fish and larger zooplankton). Store frozen -20°C.

### **Fatty acids (1 g):**

We will assist others and are interested in these data but will not have capacity for a full scale sampling and analyses on our PM and budget. Samples should be sorted as soon as possible and cryo vials should be frozen immediately in

liquid nitrogen before placed in -80°C. Larger macrozooplankton, fish samples and benthic samples should be stored in cryo zip bags.

**Carbohydrates (1 g):**

Similar procedure for sorting and storing the samples as for as for stable isotopes.

**Protein (1 g):**

Similar procedure for sorting and storing the samples as for as for stable isotopes.

**Energetics (1 g):**

Analyses will be done using a Micro-bomb calorimeter. Alternative analyses will also be considered in order to compare methods?

*Tab. 1 Target taxa for the different sample types. Minimum number of individuals per sample is indicated for zooplankton taxa.*

Target taxa	Organic pollutants	Stable isotopes	Hg	Fatty acid	Carbo-hydrate	Protein	Energetics
Sampled for 2.2.1	X	X	X	X	X	X	X
Sampled for 2.2.5		X	X	X	X	X	X
Sample size	5-10 g	0.5 g	0.5 g	1 g	1 g	1 g	xx g
Number of replicates	5	5	5	5	5	5	5
Priority	1	2	3	4			
<b>Mesozooplankton (WP3 1000µm)</b>							
<i>Calanus</i> spp.		20-30 ind		20-30 ind			
Other dominant species							



Macrozooplankton (Macrozooplankton trawl, Macrozooplankton net or MIK net)							
<i>Thysanoessa</i> spp. 0-10 mm		5 ind		5 ind			
<i>Thysanoessa</i> spp. 10-20 mm		3 ind		3 ind			
<i>Thysanoessa</i> spp. 20-30 mm		1 ind		1 ind			
<i>Thysanoessa</i> spp. >30 mm		1 ind		1 ind			
<i>Themisto</i> <i>libellula</i> 0-10 mm		5 ind		5 ind			
<i>Themisto</i> <i>libellula</i> 10- 20 mm		3 ind		3 ind			
<i>Themisto</i> <i>libellula</i> 20- 30 mm		1 ind		1 ind			
<i>Themisto</i> <i>libellula</i> >30 mm		1 ind		1 ind			
<i>Themisto</i> <i>abyssorum</i> 0-10 mm		5 ind		5 ind			
<i>Themisto</i> <i>abyssorum</i> 10-20 mm		3 ind		3 ind			
<i>Themisto</i> <i>abyssorum</i> 20-30 mm		1 ind		1 ind			
<i>Themisto</i> <i>abyssorum</i> 30-40 mm		1 ind		1 ind			
<i>Sagitta</i> spp.							
Mertensia ovum							
Beröe cucumis							

Other dominant species							
<b>Fish (pelagic trawl)</b>							
Polar cod (muscle & liver)							
Capelin (muscle & liver)							
Atlantic cod (muscle & liver)							
<b>Benthos (scrape)</b>							
Bivalves							

## 16 Ice work

### 16.1 SAFETY BRIEF

Prior to any ice station, a safety briefing is suggested to occur with the ship leadership, chief scientist and two to three scientists leading the ice work. The briefing should:

- Discuss the activities at the station, the needed time and safety precautions.
- Include a risk evaluation (e.g. wind, temperature, ice conditions, visibility (e.g. fog), swell, bears).
- Outline, when and how many people will be on the ice, and how long breaks will be with instrumentation on the ice and no people on the ice.
- Clarify communication on the ice/with the bridge (VHF channel, clear communication who is on/off the ice).

For safety reasons signals from the ship should be agreed upon (e.g. three times the ship's horn blowing) which will lead to immediate evacuation of the ice floe by scientists.

## 16.2 SELECTION OF THE ICE FLOE

The selection of the ice coring site should start ca **1 hour prior to the arrival** of the ship at station with a 10-20-minute ice observation by a deciding person (e.g. chief scientist with one or two leaders of the ice teams). The task is to establish what kind of ice is typical for the area, what kind of different ice types exist. The team will pick an ice type where:

- a) the ship can safely be moored, and
- b) a typical ice type can be sampled.

While parking the ship alongside the floe or within the floe, ice thickness can typically be evaluated. Before any person enters the ice, it should be clarified on the bridge, where sampling will occur and what an acceptable distance from the ship is.

The first people going onto the ice might wear dry suits to check ice thickness with a thickness drill at sampling sites and transect.

### **Some general comments regarding the ice station selection and length:**

- Try to avoid ship shadow in sampling area. Keep a distance of at least one ship length from ship for sampling if possible.
- Relatively homogenous level ice should be the preference for the short ice stations and the long ice stations.
- Once the main coring site for physical/biological sampling is decided upon, a clear plan should be made, where people can walk not to interfere with measurements.
- At a short ice station (5 hours):
  - Only one type of sea ice will be sampled.
  - No in situ BP/PP and sediment trap deployments will be conducted.
  - Additional sampling of melt ponds can be done.
- For the long ice stations (24hours):

- Ideally a second and third typical ice type (e.g. refrozen lead, thicker snow cover or other features such as ridges or multi-year ice) or regional patchiness in same ice type could be sampled by coring and covered in the ice thickness profiles.
- Also *in situ* deployment of PP/BP production measurements and sediment traps occur as well as extended ice thickness profiles.
- Several types of melt ponds could be sampled.

### 16.3 ICE WORKING TEAMS

On each AeN cruise, a core group needs to be assigned, who are responsible for sampling, note keeping, and then those who are responsible for processing and subsampling once samples are melted (and take care that melting is done properly).

Two ice coring/sampling teams are suggested for each ice station. Each team should consist of a minimum of four ideally five people (three/four working scientists plus one polar bear guard).

**NOTE:** Avoid making the team too big (for safety and for logistical reasons).

A) The following teams will work on a short ice station (5 hours):

Team 1:

- coring cores for physics, chemistry, nutrients, stable isotopes,
- ice thickness transects

Team 2:

- coring for biological parameters
- melt pond sampling
- under-ice water sampling

B) The following teams will work on long ice stations (24hours):

Team 1:

- coring cores for physics, chemistry, nutrients, stable isotopes,
- ice thickness transects
- snow sampling

Team 2:

- making hole for PP and sediment traps
- coring for biological parameters
- deployment of sediment traps and PP/BP as soon as ready
- continue coring for biological parameters
- sampling melt ponds
- sampling under-ice water
- recovery of in situ deployments of sediment traps prior to any sediment/benthic sampling
- recovery of PP after ca 24 hours or end of station. BP could be recovered after 1-2 hours.

#### 16.4 SAMPLING OF ICE CORES

The minimum team for ice coring consists of 3 (ideally 4) people taking and processing cores and samples, one person on polar bear watch and one person taking notes.

→ Responsibilities should be clearly identified.

→ Proper labelling of all taken samples is essential.

For handling the corer:

- use sturdy field gloves that are waterproof.
- Avoid touching the cores with bare hands.
- Be careful when handling the corer to not cut any person.
- Be very careful during the coring procedure as you deal with rotating gear that can break fingers...

- All cores should only be handled with lab gloves to avoid contamination.
- Also avoiding pieces from the cutting boards and clothing is instrumental (thin woolen gloves can be worn below lap gloves to protect from the cold).
- **For genomic work, rinse the corer with ethanol prior to sampling.** Also make sure that the cutting board is clean.
- All biological process samples (PP, BP, genomics) should NOT be exposed to bright sunlight. Use dark foil or ice tent to protect from high light intensities.

→ Clean hand & dirty hands approach: **DIRTY HANDS** only use the corer and do not touch the core at all; the **CLEAN HANDS** get the core from the barrel and cut it.

## 16.5 CUTTING OF ICE CORE

Ice cores should generally be cut into 10 to 20 cm long sections starting from the top if the core is longer than one corer length (so you process the first part of the total core from the top). **HOWEVER**, the lowermost part of the core should be cut starting from the bottom with the following bottom segments (bottom 10cm):

- 0-1cm, 1-3cm, 3-10, 10-20cm
- followed by 10 to 20cm long sections.

The cores should be taken in the following sequence:

### 16.5.1 Physics cores

- One core for temperature and salinity
- One core for stratigraphy and density

### 16.5.2 Nutrient chemistry cores

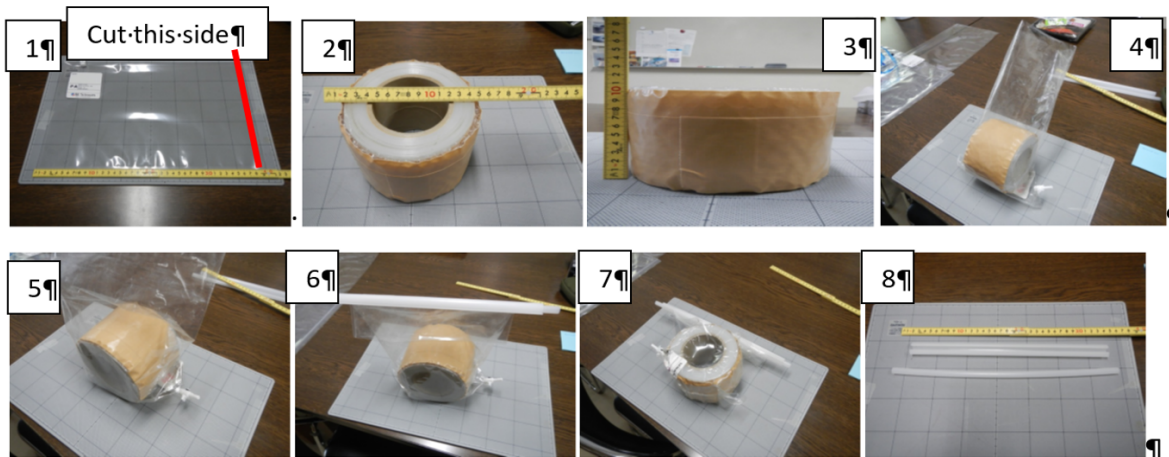
→ cut into 10 cm sections, start from top:

- 1) One core for gases/CO<sub>2</sub> (DIC/pH/AT),  $\delta^{18}\text{O}$ , nutrients and other tracers (9 or 14-cm corer). Melt each ice section in special gas-tight bags (see Fig. 14.5.2-1).
- 2) Plus, one chemistry backup core (frozen whole)

### 16.5.3 Chemistry cores

→ cut into 10 cm sections:

- 1) One core for tracers and gas measurements (14-cm corer). Merge lot of the tracers/biogeochemistry into one sample volume. Melting in special gas-tight bags (see Fig. 1).
- 2) One chemistry backup core (frozen whole)



*Fig. 1 Procedure for melting of ice cores in gas-tight bags for nutrient and chemistry cores.*

### *16.5.3.1 Iron, other trace elements and nutrients*

**Measured parameter:** Quantification of total iron and other elements

**Method responsible:** Murat Van Ardelan (NTNU, [murat.v.ardelan@ntnu.no](mailto:murat.v.ardelan@ntnu.no))

**Parameter definition:** Quantification of total iron and other elements (in nmol or  $\mu\text{mol L}^{-1}$ ) and macronutrients (nitrate/phosphate/silicate in  $\mu\text{mol L}^{-1}$ )

**Methodical description:**

→ **Special requirements:**

- Plastic gloves
- Wood or plastic equipment (some wood broom handles and nylon nets are very useful).
- (Plastic coated metal poles are ok)
- !!!! avoid rusty metal equipment
- plastic bags and containers
- clean plastic syringes
- 125 mL nalgene LDPE bottles
- 125 ml plastic bottles for macronutrient samples
- Syringe filter (0.2  $\mu\text{m}$ ) for macronutrient sample SPACE for Class-100 laminar flow clean-air chamber (2x2x1.5 m)

→ **Sample depths:**

→ **Chemicals used:**

#### **Collection of ice**

Ice samples should be collected from floating samples of ice by 'fishing' with wood or plastic equipment (some wood broom handles and nylon nets are very useful). Plastic coated metal poles are ok, but not rusty metal equipment.

Plastic gloves should be worn when handling ice or collecting samples.



It is important to randomize sample collection eg collecting every piece of ice in a suitable size range (approximately 1-4 kg), or collecting every x<sup>th</sup> sample, to avoid bias towards ice that is not an 'average' color.

After collecting an ice sample keep it in a plastic bag or container until ready to process the sample. Large samples can be smashed to collect a smaller piece for melting.

Record the location where ice was collected and give every sample a unique label.

### **Melting the ice**

Place each ice sample in a clean, airtight plastic bag.

Allow the bagged ice to melt. After 5-10% of the ice has melted, swill the melt water around the bag and discard. Then re-seal the bag and continue the melting. We do this to remove films that may be present on the ice surface.

Repeat this melt-swill-discard process 5 times. If the bag tears, move the ice to a new bag.

After throwing away the meltwater 5 times, allow the water to accumulate until about 200 mL is in the bag.

### **Sampling for iron and nutrients**

Using either a clean syringe (provided) or by gentle tipping, fill a pre-cleaned 125 mL nalgene LDPE bottle (provided) for analysis of iron. Ideally, up to the 125 mL mark, but anything from 25-125 mL is ok. Seal the LDPE bottles quickly and then store in clean plastic bags in a cool, dark place. Label the bottles with the sample name.

The remaining water can be filtered (0.2  $\mu\text{m}$ ) and preserved for nutrient analysis. If keeping nutrient samples for later analysis, preserve by freezing and/or addition of Hg. Label the bottles with the sample name.

#### 16.5.4 Backup core

→ frozen whole

#### 16.5.5 Primary/bacterial productivity cores

- Three cores, and cut off the bottom 1cm (maximum biomass layer), place into clean zip-lock bag, add 500ml of 0.2µm filtered sea water and mix thoroughly.
- Then transfer into incubation bottles for PP and BP.
- Do all work in ice tent.
- Immediately prepare the incubations by adding the tracers in the isotope lab or if possible directly in the field.
- Transport always in a dark cooler.

#### 16.5.6 Primary production P vs I curve core

Take one ice core, cut off bottom 0-1cm. Take back to ship and add 450ml of GF/F filtered sea water in Duran bottle. Use for P vs I curve.

Biology cores BULK (cut into 0-1, 1-3, 3-10, 10-20 and 20 cm sections thereafter starting from bottom):

After cutting all biological samples need to be stored dark and in a cooler for transport back to the ship.

Three 9-cm cores pooled into one sample for biology (bulk variables: Chl a, POC/N, particle absorption, DNA/RNA?)

- Ice core sections are transferred into melting buckets (1 – 6 L depending on section length)
- Ice core sections are chopped up inside buckets to speed up melting process (make sure chopping device is clean)
- Ice cores are melted directly (without addition of FSW) at room temperature if constantly monitored or in a cold room (4degC). Needs to be done in the dark

- Swirl bucket contents regularly to ensure homogenous, low temperature
- As soon as ice cores have melted proceed with sample processing
- First measure total volume of sample, take salinity reading with salinity probe and make sure melting buckets are well mixed before subdividing into various parameters
- Measure exact volume with measuring cylinder for each parameter
- Proceed as outlined in sampling protocols for each variable

### 16.5.7 Meiofauna and protist cores

→ same sections as for bulk biology cores, only bottom 30cm:

Three extra cores are taken for meiofauna. Process only the bottom 30cm. Place into zip-loc bags. Add 100ml of GF/F filtered sea water for each cm of ice core length to avoid osmotic stress, which leads to organism loss. After complete melt, take a 100ml subsample for protist count (fix with Lugol) and concentrate the remaining volume for meiofauna over a 20µm sieve (fix with buffered Formaldehyde).

Core sections are melted at room temperature in filtered seawater in melt buckets or in ziplock bags (double-bagged). Add 100 ml per 1 cm of section, meaning 1000ml for the 0-10 cm section. Filtered seawater and cool temperatures will ensure that organisms will not burst. Concentrate the organisms on the 20 µm sieve (small metal sieve) and rinsed into a vial or jar (~20 ml or larger) using a spray bottle with filtered seawater. Preserve the sample with 37% formaldehyde diluted 10x with filtered seawater to 4%. Do not freeze!

### 16.5.8 Stable isotope cores

→ one whole

### 16.5.9 Genomic cores

Three cores pooled. Use ethanol washed corer and cutting board or very clean sampling area.

## 16.6 DEPLOYMENT OF IN SITU INCUBATIONS/SEDIMENT TRAPS

These deployments should be done as fast as possible during the long stations to allow long incubation times.

Making Ice hole:

Use ice auger and ice saws to cut a hole into the sea ice (size: 75x75cm). If ice is thicker than 1.5m likely no hole big enough for sediment traps can be made. Then deploy only PP through ice auger hole as soon as the incubations are ready (spiked water samples from CTD and from above mentioned). For sediment traps you can use an open lead close to the ship (not for PP/BP) (risk: leads can close).

## 16.7 ON-ICE CTD

Use hand-held on-ice CTD (e.g. UiT CTD) for one deployment from the ice through auger hole down to 90m water depth. If equipped with light sensor, than make sure, that you are not in the ship shadow.

## 16.8 ON-ICE WATER SAMPLER

If a small hand-held water sampler is available, one water sample depth should be selected (ca 0.5m under ice bottom) for full set of variables/parameters (similar to ice cores, see Table 14.5.2-1). Some hand-held water samplers can be deployed through a 14cm ice corer hole, otherwise use larger ice auger.

## 16.9 MELT POND SAMPLES

If melt ponds exist, one melt pond should be selected for a full set of samples similar to ice cores

## 16.10 SNOW SAMPLING

Should be done mainly for physical and nutrients properties, potentially also for biology.

Before ice coring, snow samples are collected at each sea ice collection area. Depending on the thickness of the snow, 1-2 snow samples are collected, e.g. when snow cover is 10 cm thick, one sample 0-5 cm (ice surface to 5 cm) and one sample 5-10 cm (5 cm to snow surface) are collected. If there is a slushy layer, this layer is collected as well. Temperature is measured in each snow/slushy layer. The snow is collected using a plastic spoon and put into gas-tight bags, then air is removed with the air pump, then the snow sample is melted in cool and dark place. Same procedure is used as for the sea ice samples. When melted, samples for DIC/AT,  $\delta^{18}\text{O}$ , nutrients are taken according to the Sampling protocol.

## 17 Geological sampling

**Method responsible:** Tine Rasmussen (UiT, tine.rasmussen@uit.no), Matthias Forwick (UiT, matthias.forwick@uit.no), Elisabeth Alve (UiO, Elisabeth.alve@geo.uio.no), Katrine Husum (NPI, katrine.husum@npolar.no), Ulysses Ninnemann (UiB, ulysses.ninnemann@uib.no)

*Tab. 1 Overview of geological sampling effort and institutions responsible. TR: Tine Rasmussen. MF: Matthias Forwick. BF: Benthic foraminifera. PF: Planktic foraminifera. BF d18O, d13C: stable isotope analysis ( $d^{18}O, d^{13}C$ ) measured on benthic foraminifera. PF d18O, d13C: stable isotope analysis ( $d^{18}O, d^{13}C$ ) measured on planktic foraminifera.*

Speciality & analysis	UiT (TR)	UiO	UiB	NPI	UiT (MF)
AMS 14C	X	X	X	X	X
210Pb	X	X	X	X	X
BF 0 - 2 ka		X			
PF 0 - 2 ka	X				
BF > 2ka	X				
PF > 2ka	X				
BF d18O, d13C 0 - 2 ka		X			
BF d18O, d13C > 2ka			X		
PF d18O, d13C 0 - 2 ka			X		
PF d18O, d13C > 2ka			X		
Water d18O, dD, d13C <sub>DIC</sub>			X		
Mg/Ca			X		
Clumped isotopes			X		
HBIs (eg IP25)				X	
Diatoms				X	
Coccoliths				X	
Trace elements/Ca (ikke Mg/Ca)	X				
11B	X				
Seafloor and sub-seafloor mapping					X
Physical properties					X
X-radiographs					X
Colour imaging					X
XRF core scanning					X

Lithostratigraphy					X
Granulometry					X
IRD (flux and composition)					X

## 17.1 SEDIMENT SAMPLING

### 17.1.1 Short sediment cores (2 ka) – Multicorer

The multi corer automatically gives four multicorer tubes:

- At least two casts will be carried out with multicorer in order to obtain sediment cores for the analyses and proxies (Table 1).
- Three casts will be carried out at stations where it is also planned to analyze porewater and sediment geochemistry (ChAOS).
- Samples from sediment cores that are sampled onboard will be kept frozen. Other cores will be stored cold (0-5° C).
- Further processing and analysis will be carried out onshore at NPI, UiB, UiO, UiT and UniRES (see table below).

*Tab. 1 Overview of multi core sampling for proxies and parameters*

Proxy – parameters	Number of multicores	Partner
Paleo benthic foraminifera, planktic foraminifera	1	UiO, UiT
Living benthic foraminifera	3	
Stable isotopes	1	UiB
IP25, diatoms, aDNA, dinocysts	1	NPI, UniRES
Sedimentology	1	UiT
Reference	1	UiO/UiT/UiB/NPI
Porewater, sediment geochemistry	2	ChAOS, UiT

### *17.1.1.1 Sampling protocol - Multicorer*

#### Method

- Remove water from multicorer tube.
- Prior to sub-sampling take a photograph of surface and one of the sediment core.
- Determine texture (clay, silt/sand/rocks) and colour using Munsell colour chart. Make notes of any disturbances, presence of benthic biota.
- Sub-sample in 0.5 cm steps down core using metal plates.
- If the sediments are very fluid spoon may also be applied.

### *17.1.1.2 Living (stained) and fossil benthic foraminifera*

**Measured parameter:** Living and fossil benthic foraminifera

**Method Responsible:** Elisabeth Alve (UiO, Elisabeth.alve@geo.uio.no)

**Description of parameter/Aim:**

**Methodological description:**

→ **Special requirements/gear:** Multi corer (105 mm diameter)

→ **Sampling depths:** Station bottom depth

→ **Chemicals used:** Ethanol (96 %), Rose Bengal.

**Method:**

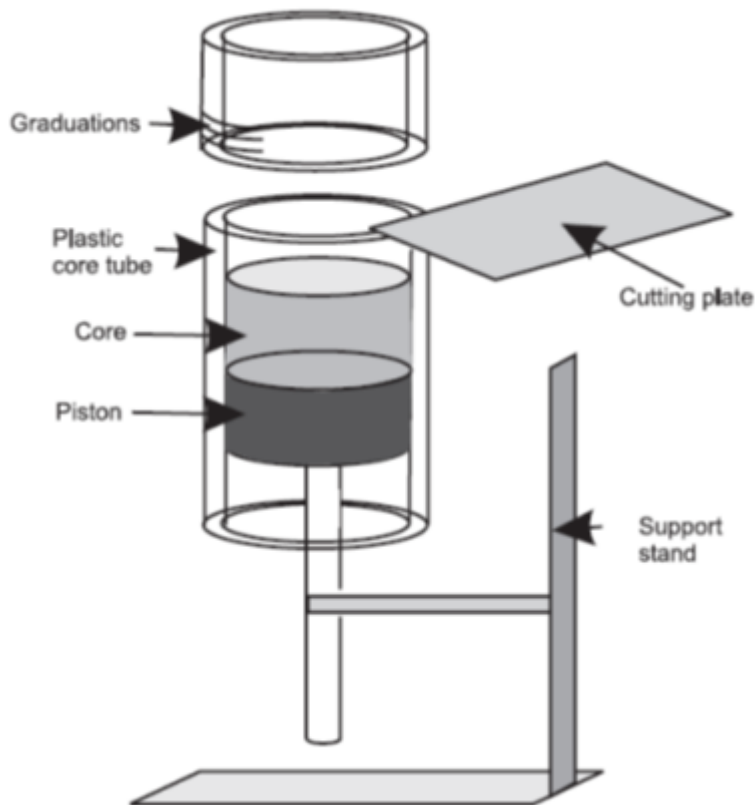
- Multi corer (105 mm diameter), which allows for the recovery of intact sediment-water interface.
- Stand with a piston.
- Shorter section of the core tube graduated with 1 cm mark.
- Slicing plates.
- Siphon.
- Plastic pipettes.
- 180 ml Joni plastic containers.
- Zip log bags.



- Ethanol (96 %).
- Rose Bengal.
- Notebook.
- Camera.
- Permanent marker pen.

### Short multicores (~ 2 kyrs):

- Note down weather condition (if working outside) and sample process time.
- Place the core on a stand with a piston that fits the plastic core tube (Fig. 1).
- Remove excess water above the sediment surface by using a siphon before pushing the core liner down on the piston in order to avoid sediment in suspension. Remove residual surface water using plastic pipettes.
- Prior to sub-sampling, take a photograph of the surface with label.
- Note down colour, texture, biota and possible disturbances, e.g. bioturbation, during slicing.
- If the sediment surface is irregular, define the sub-sample as the midpoint between the highest and the lowest point (measure the distance between these) (Schönfeld et al. 2012).
- Slice the sediment core using a slicing plate and a graduated, shorter section of the core tube (see Fig. 1).
- It is important to move the plate and sample horizontally when slicing to avoid dragging up sediment from the lower layer.



*Fig. 1 Schematic representation of a stand with a piston for sediment slicing (Licensed Material: Murray 2006, Cambridge University Press).*

### Sampling for palaeoceanographic and fossil benthic foraminifera analyses:

- Sub-sample one sediment core in 1 cm intervals down to 40 cm.
- Due to high water content in the sediment surface, transfer samples down to 5 cm to 180 ml Joni plastic containers, and in zip log bags from 5-40 cm. Store the zip log bags in one large zip log bag to separate samples from the different stations.
- Store the sub-samples frozen (- 20 °C).
- It is important to avoid adding too much pressure on the lid when closing the plastic containers, as the containers might break. Instead, push the lid down in one place and drag your finger around until you hear a click.

### Sampling for living (stained) benthic foraminifera:

- Sub-sample three sediment cores in 1 cm intervals;
- One core down to 10 cm. pH may be measured in the sub-samples.
- Two cores down to 4 cm.
- Transfer the sub-samples to 180 ml Joni plastic containers and add at least an equal volume of rose Bengal (2 g/L) stained 80 % ethanol.
- Mix the samples thoroughly (but gently) until homogenized - examine the bottom of the container to see if any sediment is still clumping together (Fig. 2).
- It is important to avoid adding too much pressure on the lid when closing the plastic containers, as the containers might break. Instead, push the lid down in one place and drag your finger around until you hear a click.



*Fig. 2 Well-mixed sample (left) and not sufficiently mixed sample (right).*

### Literature

- Murray, J.W., 2006. Ecology and Applications of Benthic Foraminifera. Cambridge University Press, Cambridge.
- Schönfeld, J., Alve, E., Geslin, E., Jorissen, F., Korsun, S., Spezzaferri, S., 2012. The FOBIMO (FORaminiferal Blo-MONitoring) initiative — Towards a standardised protocol for soft-bottom benthic foraminiferal monitoring studies. Marine Micropaleontology 94-95: 1-13.

#### *17.1.1.2 Stable isotopes*

- One multicorer tube will be sampled from top of the core to the bottom for every 0.5 cm.
- Samples will be kept in plastic zip log bags and frozen ( $< 0^{\circ}\text{C}$ ).

#### *17.1.1.3 Diatoms*

- One multicorer tube will be sampled from top of the core to the bottom for every 0.5 cm.
- Samples will be kept in plastic zip log bags and frozen ( $< 0^{\circ}\text{C}$ ).

#### *17.1.1.4 IP25 and Dinocyst sampling protocol*

**Measured parameter:** Sea ice biomarkers (IP25) and dinocysts

**Method responsible:** Katrine Husum (NPI, [katrine.husum@npolar.no](mailto:katrine.husum@npolar.no)), Stijn de Schepper (UNIResearch, [stde@norceresearch](mailto:stde@norceresearch))

**Description of parameter/Aim:** Sea ice reconstruction

**Methodical description:**

→ Special requirements/gear:

→ Sampling depth:

→ Chemicals used:

**Material:**

- Spatulas
- Plastic bags
- Marker

## Method:

- 1) Amount: ca. 1/3 of opened core half.
  
- 2) Which interval:
  - Multicore and Gravity core: 1 cm slice samples in 1 cm intervals, starting at the top.
  - IP25 and Dinocyst samples were taken from multicores at stations NPAL04, NPAL05, NPAL07, NPAL08, NPAL12, NPAL14, NPAL15, NPAL17 and from gravity cores at stations NPAL04, NPAL08 and NPAL15.
  - No Calypso core was sampled on the cruise.
  - Diatoms were not sampled on the cruise. This is planned to be done in the same manner as IP25 and Dinocysts at a later stage (on archive half of the same cores).
  
- 3) Pre-sampling
  - Cores on deck are brought to the lab.
  - Cores are split. One half (work) is taken away for aDNA sampling. Another half is logged (archive). After aDNA sampling, the remaining material is sampled for IP25 and Dinocysts (multicores only).

## → Sample storage:

- Samples are stored in a cooling room at approx. 4 oC.
- Transport:
  - Bergen (NORCE): Dinocyst
  - Tromsø (NPI): IP25Samples should be transported to Bergen/Tromsø in a cooling container.

#### *17.1.1.5 Sedimentology*

- One multicorer tube will be sampled from top of the core to the bottom for every 0.5 cm.
- Samples will be kept in plastic zip log bags.

#### *17.1.1.6 14C-Dating sampling protocol*

**Measured parameter:** 14C radiocarbon dating (of calcareous microfossils)

**Method Responsible:** Katrine Husum (NPI, katrine.husum@npolar.no), Ulysses Ninnemann (UiB, ulysses.ninnemann@uib.no), Elisabeth Alve (UiO, Elisabeth.alve@geo.uio.no), Matthias Forwick (UiT, matthias.forwick@uit.no), Tine Rasmussen (UiT, tine.rasmussen@uit.no)

**Description of parameter/Aim:** 14C radiocarbon dating (of calcareous microfossils). Dating the sediment

**Methodological description:**

→ Special requirements/gear:

→ Sampling depths:

→ Chemicals used:

**Material**

- Spatulas
- Plastic bags
- Marker

## Method:

- 1) Amount: ca. 1/3 of opened core half.
  
- 2) Which interval:
  - Multicore: 2 samples, 1 cm slices ca. 5 cm from the bottom and 5 cm from the top (or where it seems reasonable). Samples were taken from the archive half of multicores sampled for IP25 and Dinocysts.
  - Calypso/gravity core: 3 samples per section. 1 cm slices ca. 5 cm from the bottom, in the middle and 5 cm from the top (or where it seems reasonable). Samples were taken from the work half after aDNA-sampling, or pore water sampling (ChAOS)
  - Dating samples were taken from multicores at stations NPAL04, NPAL05, NPAL07, NPAL08, NPAL12, NPAL14, NPAL15, NPAL17 and from gravity cores at stations NPAL04, NPAL08, NPAL14 and NPAL15.
  
- 3) Pre-sampling:
  - Cores on deck are brought to the lab.
  - Cores are split. One half (work) is taken away for aDNA sampling or pore water sampling. Another half is logged (archive). After, the work sections are sampled for dating (GC only). For multicores, dating samples are taken from the archive half.

### → Sample storage/Transport:

- Samples are stored in a freezer at approx. -20 to -30 °C.
- Transport: Samples should be transported to Tromsø on dry ice or in a freezing container to ensure that the samples.

#### *17.1.1.7 Sediment geochemistry (ChAOS project)*

- Sediment samples will be taken from one multicorer tube.
- Sediments will be sliced for every 0.5 cm resolution down to 20 cm, and in 2 cm resolution below 20 cm sediment depth.
- Samples will be kept in standard zip lock bags.
- It is critical that these samples are frozen as soon as possible after sampling (ideally at -80°C, otherwise at -20°C) and are directly transferred into a freezer back at shore.
- Data to be generated onshore at University of Leeds, UK: TOC, TN, TS, C/N ratios, Fe speciation.

#### *17.1.1.8 Ancient DNA (aDNA) sampling protocol*

**Measured parameter:** DNA (ancient DNA from bulk sediment samples)

**Method Responsible:** Stijn de Schepper (UNIResearch, stde@norceresearch),  
Katrine Husum (NPI, katrine.husum@npolar.no)

**Description of parameter/Aim:** DNA (ancient DNA from bulk sediment samples). Purpose: Sea ice reconstruction.

**Methodological description:**

→ Special requirements/gear:

→ Sampling depths:

→ Chemicals used:

**Material:**

- single-use sterile 12ml polypropylene syringes (n= depends on sampling strategy)
- knife
- scissors



- disposable gloves (good to have both large and medium)
- single use large plastic spoons
- single use small plastic spoons
- -OR- metal spatula, wiped clean and flame-sterilized between samples
- sampling bags
- permanent marker for labelling
- sticky labels for sampling bags
- aluminum foil to work on a clean working desk and/or ethanol for cleaning workspace
- pre-cut "skumplast/oasis" (rubber foam) to fill in holes in sediment core
- Bunsen burner or lighter for flame-sterilizing knife

#### Method:

- Amount: At least 10cc per, more if available and if sediment is "soupy".
  - We need minimum 3 to 5 gram dry sediment for our DNA analyses.
- 1) Which interval:
- Multicore: 2 samples at 0-1.5 cm, one to be stored in the freezer (-20- -30oC) and one to be stored in the fridge (ca. 4 oC).
  - All samples are taken with syringes with 1.5 cm diameter.
  - Multicores from sites where gravity cores also are taken are sampled downcore at same intervals as the gravity core to ensure overlap between the cores.
  - Calypso/gravity core: Sampled downcore at 1.5 cm slices in intervals reflecting ca. every 200-250 years.
  - Multicores were sampled at the top at every station. At station NPAL04, NPAL08, NPAL15 and NPAL17 one multicore half was sampled downcore.
  - Gravity cores from station NPAL04, NPAL08 and NPAL15 were sampled downcore.
  - One piston core (KH18-10-15-PC03) was sampled. Samples were taken at the top and bottom of each section (except for section 1, where we only took bottom samples). The length of the material was measured and represents the approx. sampling interval.

## 2) Pre-sampling:

- Cores on deck are brought to the lab.
- Cores are split using clean tools.
- Split halves are cleaned by scraping off top sediment perpendicular to the main core axis, to avoid contamination from opening the core.
- If needed for cleaning the core/core liner: use fresh water or sterile, filtered (<0.2 µm) sea water.

## 3) Preparation:

On as clean workspace as possible (use aluminum foil as cover):

- Wear \*clean\* disposable gloves
- Label sample bags
- Label syringes with permanent marker on the tube
- Use unique labels that include cruise, station, site, core type and depth (cm):
- e.g. "SIMEP-XX-STATION-CORE-xx" or similar
- Keep a log of all sediment samples taken
- Remove top from syringe using a sterilized knife
- Pull up (not out!) inner part of syringe and put in a plastic bag.

## 4) Core sampling:

- Sampling control. Place an Eppendorf tube open, on the bench, close to the core and your sampling spot. Give the sampling control an ID and make sure to track which sample(s) while the tube was open.
- Press syringe into sediment. Avoid to reach the core liner – i.e. leave some sediment – to prevent contamination from the core liner
- Pull syringe out of sediment
- When syringes do not work optimally (soupy sediments) use disposable spoons or metal spatula, wiped clean and flame-sterilised between samples
- Fill hole in sediment core with "skumplast"
- Close the sampling control (i.e. keep open during process of 1-3 samples (or what seems reasonable), and freeze the sampling controls in a tube/box (the same way you treat the syringes).

### → Sample storage/Transport:

- Put complete syringe with sediment into labeled sampling bag. Put syringe with sample into the -20 °C freezer asap
- Transport: Samples should be transported to Bergen on dry ice. At least 5-6 kg dry ice will be necessary to keep samples frozen during transport.

#### 17.1.2 Long sediment cores (14ka) – gravity/calypso corer

The long cores are cut for every m (GC) and every 1.5 m (PC) and carefully labelled. Those sediment cores that are sampled for pore water and/or for aDNA are opened and described onboard. Further sampling onboard is problematic due to carbonate dissolution which most probably will occur when the sediments are oxygenated. All cores will be logged with regard to magnetic susceptibility, color and photographed.

##### 17.1.2.1 Laboratory analysis

###### 17.1.2.1.1 Opening cores

Cores that will be opened will be extensively sampled onboard due to the potential loss of carbonate fraction after opening. All samples will be frozen immediately. Depending upon time and capacity we will try to process all cores completely, but in the case of backlog some (e.g. longer PC) cores may be stored for postcruise processing.

###### 17.1.2.1.2 MSCL

The magnetic susceptibility of the sediments will be measured on the surfaces of opened cores using a point sensor attached to a GEOTEK Multi Sensor Core Logger. Simultaneously, the colour properties will be measured with a spectrophotometer. Measurements will be made for every cm onboard and with a higher resolution onshore.

### 17.1.2.1.3 Lithological description

Lithostratigraphy will be established from visual descriptions of the surfaces of opened cores. Parameters of particular interest include lithological variations, colour changes, structures, signs of biological activity (bioturbation, occurrence of whole shells and shell fragments, as well as microorganisms).

## 17.2 WATER SAMPLING

### 17.2.1 Geology proxy development of stable isotope analysis

**Measured parameter:** H, O, C,  $\delta^{13}\text{C}$  of DIC

**Method responsible:** Ulysses Ninnemann (UiB, [ulysses.ninnemann@uib.no](mailto:ulysses.ninnemann@uib.no)),  
Pål Tore Mørkved (UiB, [pal.morkved@uib.no](mailto:pal.morkved@uib.no))

**Description of parameter/Aim:**

**Methodological description:**

→ **Special requirements/gear:**

→ **Sampling depths:** Upper 150m: 150, 100, 50, 25, 10, 5, 0m (adjust depending on local mixed layer and near surface stratification features).  
Maximum 12 bottles

→ **Chemicals used:** Mercury(II)chloride

CTD water sampling:

- 12 x 8L Niskin bottles (bottle #1 is from the deepest depth)
- Sensors: Chl & CDOM fluorescence, O<sub>2</sub>, transmissometer 660 nm, PAR, sPAR
- One cast whole water column for biology & chemistry

### Sampling from ship CTD:

- Stable isotopes 60 ml serum vials with septa and crimpcaps

### **Sampling depths stable isotopes (H, O, C):**

- Upper 150m: 150, 100, 50, 25, 10, 5, 0m (adjust depending on local mixed layer and near surface stratification features). Maximum 12 bottles
- Lower resolution sampling to (and including as close as possible and within 10m of) seafloor to define any major water masses.
- Stable Isotopes ( $\delta^{18}\text{O}$  -  $\delta_{\text{D}}$ )

### Collecting the sample:

- Sample evaporation and/or moisture condensation in the sample bottle must be avoided at all costs!
- Sampling from the Niskin bottles are done into 60 ml serum vials with butyl rubber septa and crimpcaps.
  1. Rinse the vial and septum with sample three (3) times. This removes any water than may have condensed inside the bottle/cap.
  2. Fill the vial and cap with seawater from the Niskin bottle (it is practical to use a silicon tube (i.d. 7mm), similar to the DIC sampling.
  3. Apply the septum to the vial without touching the inside. Do not crimp the crimp cap. Press the septum sideways to release overpressure so the cap does not pop off.
  4. Turn the bottle upside down and check for a small air bubble. If the bubble is too small loosen the septum and tighten it again.
  5. When all the  $\delta^{18}\text{O}$  samples have been collected from one CTD, dry the vials, crimp the caps (and seal with Parafilm following the instructions below / on the next page.)

6. Store the  $\delta^{18}\text{O}$  samples at room temperature or in a fridge.

Alternative for onboard measurements with a Picarro:

4b) Bring the bottles to the lab. For each sample, transfer 1.7 ml to 2 ml labelled GC vials with screwcaps and PTFE lined butyl rubber septa using a 1 ml pipette. GC vials are stored upside down in boxes with lids in the fridge.

5b) Serum vials and septa can then be emptied, washed with DI water and dried for reuse or capped and crimped for refrigerated storing of sample for backup or further onshore measurements.

**Sampling for  $\delta^{13}\text{C}$  of DIC in seawater:**

SAMPLING DEPTHS (ocean acidification studies) are as above.

Equipment: Glass bottles 60 ml with butyl rubber septa and crimp caps, silicon tube (i.d. 7mm at KH), Mercury(II)chloride (in saturated solution in DI water, >7.4 g/100 mL, 20 °C), gloves.

1. Use gloves and goggles when handling the saturated Mercury(II)chloride and the fixed samples.
2. The bottles should be numbered before sampling, please use this number as reference.
3. Rinse the vial and septum with sample three (3) times. This removes any water that may have condensed inside the bottle/cap. Use the silicone tube to transfer water from the Niskin bottles to the sampling bottles.
4. The tube should be placed in the bottom of the sampling bottle when filling. Make sure there are no bubbles inside the tube when filling. This might require reducing the flow from the Niskin bottle.
5. Overfill the sample bottle with one bottle volume. Make sure no bubbles are trapped inside the sample bottle. Put the lid on so excess water runs out (squeeze sideways and down). When you have filled all sample bottles transfer them back to the laboratory.

6. Dry all the bottles with paper towel. Paper towels go in a black or clear waste bag (normal waste).
7. Using gloves and goggles and working in the fume hood add 5 drops of saturated Mercury(II)chloride from the small drop-bottle or using syringe w/needle to each bottle. Put the septum back on and secure it with a Crimp cap. Make a permanent, separate working area for Hg work (e.g. a fume hood) to avoid spreading Hg spill to the rest of the lab. Use bench paper and change gloves often to avoid spreading the mercury.
8. Dry of the bottles with paper towel in case of spillage. This paper goes in the zip bag labelled hazardous waste.
9. Put the dry bottles in the cooling room (NO FREEZING!). In case any spill dry with paper towel and put in the yellow plastic bag. All used gloves go in the hazardous waste.

For onboard analyses on a Thermo Delta Ray instrument:

5b) One extra bottle is sampled per sample. The vial is filled as in 5).

6b) as 6).

7b) Transfer 1 ml sample, using a 1 ml syringe, to each of 3 exetainers (Labco,UK) pre-prepared with 5 drops of 99-100% phosphoric acid each. Exetainers w/acid must be flushed with synthetic air before adding the sample (usually done onshore). No Hg is needed.

8b) stir (rotate glass) gently with vial remaining near vertical to mix water and acid and measure after the water reaches constant temperature (room temperature).

## 18 Methods guest researchers and previous cruises

As many researchers only join 1-2 cruises and then their sampling will not be continued, we opened this chapter for protocols of guest researchers.

### 18.1 TOC, TN, TS, C/N RATIOS, FE SPECIATION

**Measured parameters:** TOC, TN, TS, C/N ratios, Fe speciation

**Method responsible:** Christian Maerz (University of Leeds, c.maerz@leeds.ac.uk), Matthias Forwick (UiT, matthias.forwick@uit.no), Katrine Husum (Katrine.husum@npolar.no), Ulysses Ninnemann (UiB, ulysses.ninnemann@uib.no)

**Description of parameter/Aim:**

**Methodological description:**

→ **Special requirements/gear:**

→ **Sampling depths:** Multicore (pore water) sampling: BW, 0.5, 1.5, 2.5, 4.5, 6.5, 8.5, 10.5, 12.5, 14.5, 16.5, 18.5, 20.5, 25.5, 30.5 etc.

→ **Chemicals used:** HCl

#### 18.1.1 CTD sampling for nutrients and ICP analysis

**Material:**

- 12 MQW rinsed (5x) 500 mL or 1 L bottles
- 12 MQW rinsed 50 mL syringes
- 12 centrifuge tubes
- 12 60 mL Nalgene
- 12 syringe filters
- HCl (conc.)



## Method:

1. Label 12 acid washed and MQW rinsed (5x) Nalgene bottles (0.5 to 1 L) for sampling from the CTD Niskin bottles.
2. When sampling from the Niskin, rinse 3 times while sampling before filling the bottle.
3. In the lab, take a dry, MQW rinsed 50 mL syringe and using the CTD water, rinse the outside of the syringe.
4. Next, take up 10 mL of CTD water in the syringe. Hold the syringe vertically and pull down on the plunger to rinse the inside of the syringe 3 times.
5. Fill the syringe with CTD water and add the syringe filter to the syringe tip. Push out 10 mL of CTD water to rinse the syringe filter.
6. Rinse the Nalgene bottle with water from syringe 3x and then fill the bottle to just below the shoulder. Close the bottle and parafilm the cap. These samples will be flash frozen at -80C for several hours and then stored in -20C for the remainder of the cruise.
7. Rinse a centrifuge tube with water from the syringe 3x and then fill the tube. Ten uL of HCl will be added to each tube and they should be stored at 4C.

## 18.1.2 Multicore sampling

### 18.1.2.1 Pore waters

→ **Sample depths:** BW, 0.5, 1.5, 2.5, 4.5, 6.5, 8.5, 10.5, 12.5, 14.5, 16.5, 18.5, 20.5, 25.5, 30.5 etc.

→ **Chemicals used:** HCl

## Material:

- Supplies needed
- Rhizons
- Rhizon spacers
- Syringes labelled with appropriate core depths
- Centrifuge tubes (15 mL)
- Nalgene bottles (1-60 mL and 15 mL for all sediment depths)
- Isotope vials
- HCl (conc.)

## Method:

1. Core tubes should be drilled (0.4 cm) every 1 cm. The holes should be covered with clear office tape to avoid leaking.
2. Once cores are brought on deck, they should be cleaned and measured. The sediment core should then be transferred to the sink in the wet lab and secured with a bungee cord.
3. Using a pipette tip, a hole above the sediment water interface should be punctured and the rhizon inserted and attached with a syringe and a spacer. Once the syringe is filled, transfer water into the vials and tubes (and repeat) until a 60 mL Nalgene is filled for nutrients, a 15 mL centrifuge tube is filled for ICP work, a 15 mL centrifuge tube is filled for IC work, and 1 mL is transferred to the vial for isotopes. After these are full, remove the syringe and drain the remaining bottom water.
4. While bottom water is being removed, holes should be punctured and rhizons inserted starting from the bottom sample to 4.5 cm. Syringes can then be added. The 0.5 cm horizon will be set at the first sample below the sediment water interface. Once all overlying water has been removed, the holes at 2.5, 1.5 and 0.5 cm depth were opened, and rhizons were inserted very quickly to avoid the loss of pore water from the very water-rich uppermost sediment horizons. Rhizons will be left in the core tubes for up to ~2 hours, depending

on the efficiency of pore water extraction (very fast in the top layers, much slower in deeper, clay-rich layers).

- Once all rhizons have finished extracting water, the water should be divided as follows:

Sample type	Min volume	Max volume	Storage
ICP	3 mL	15 mL	10 uL HCl in centrifuge tube, stored at 4C
Nutrients	11 mL (6 for dilution)	12-13 mL	Nalgene, capped tightly and parafilmmed, flash frozen at -80C standing up before storage at -20C
Isotopes	0.5 mL	0.8-1 mL NO MORE	Transferred by syringe to vial for dry lab for analysis

#### IMPORTANT:

If less than 3 mL → all sample to ICP

If 3-8 mL → 1 mL to isotopes (air); remainder to ICP

If 8-15 mL → 3 mL to ICP; remainder to Nut

If 16 mL → 3 mL to ICP, 12 mL to Nut; 1 mL to isotopes (air)

If >16 mL → 12 mL to Nut; 1 mL to isotopes (air); 1 mL to isotopes (He); remainder to ICP

#### 18.1.2.2 Sediments

Material:

- Whirl pak bags
- Sampling tools (plastic plates and rings)
- pH meter (calibrated)
- pH probe
- DI bottle and Kim Wipes

## Method:

1. Sediment samples for both multi- and gravity cores should be sampled and frozen soon after cores are opened to avoid oxidation of sulfides and Fe in pore waters.
2. The core should be transferred to a core extruder on deck. Remove most overlying water using a silicon tube. The pH meter should be calibrated prior to sampling. Clean pH probe with MQW water. Be sure to remove any salt from probe. Measure pH within the overlying water. The remaining water should be removed with a disposable pipette.
3. Prior to extruding core, measure pH on the surface 3 times and record by hand in notebook. Clean pH probe thoroughly with MQW water.
4. Extrude core 1 cm by turning the crank two full turns, slice and transfer to labelled bag. Sample entire core at 1 cm intervals. Samples should be stored at -20°C.

### 18.1.3 Gravity core sampling

#### 18.1.3.1 Pore waters

## Material:

- Drill and 0.4 cm drill bits
- Rhizons
- Rhizon spacers
- Syringes labelled with appropriate core depths
- Centrifuge tubes (15 mL)
- Nalgene bottles (1-60 mL and 15 mL for all sediment depths)
- Isotope vials
- HCl (conc.)

Method:

1. Gravity core sections should be transferred to wet lab counters and secured using bungee cords.
2. Holes should be drilled every 15 to 30 cm (based on section length). A rhizon should be inserted into the hole and a syringe should be attached and a spacer added. Rhizons should be left for 2-3 hours.
3. Pore waters should be divided and treated in the same way as the multicore pore waters above.

#### *18.1.3.2 Sediments*

Material:

- Sample bags
- Sampling tools (spatulas)

Method:

1. Sediment samples for both multi- and gravity cores should be sampled and frozen soon after cores are opened to avoid oxidation of sulfides and Fe in pore waters.
2. Split core should be sampled at 1 cm intervals (a third to a half of the working half).
3. Samples should be immediately frozen at -20°C.

# The Nansen Legacy in numbers

## 6 years

The Nansen Legacy is a six-year project, running from 2018 to 2023.

## 1 400 000 km<sup>2</sup> of sea

The Nansen Legacy investigates the physical and biological environment of the northern Barents Sea and adjacent Arctic Ocean.



## >10 fields

The Nansen Legacy includes scientists from the fields of biology, chemistry, climate research, ecosystem modelling, ecotoxicology, geology, ice physics, meteorology, observational technology, and physical oceanography.

## >350 days at sea

The Nansen Legacy will conduct 15 scientific cruises and spend more than 350 days in the northern Barents Sea and adjacent Arctic Ocean between 2018 and 2022. Most of these cruises are conducted on the new Norwegian research icebreaker *RV Kronprins Haakon*.

## 250 people

There are about 210 researchers working with the Nansen Legacy, of which 50 are early career scientists. In addition, 40 persons are involved as technicians, project coordinators, communication advisers and board members.

## 10 institutions

The Nansen Legacy unites the complimentary scientific expertise of ten Norwegian institutions dedicated to Arctic research.




## 50/50 financing

The Nansen Legacy has a total budget of 740 million NOK. Half the budget comes from the consortiums' own funding, while the other half is provided by the Research Council of Norway and the Ministry of Education and Research.



 [nansenlegacy.org](https://nansenlegacy.org)

   [nansenlegacy](#)

 [nansenlegacy@uit.no](mailto:nansenlegacy@uit.no)