

the Nansen LEGACY



Sampling Protocols
Version 6



Sampling Protocols

Version 6

March 31, 2020

To be cited as: The Nansen Legacy (2020). Sampling Protocols: Version 6. *The Nansen Legacy Report Series* 14/2020. DOI: <https://doi.org/10.7557/nlrs.5720>

© The authors. This report is licensed under the [Creative Commons Attribution 4.0 International](https://creativecommons.org/licenses/by/4.0/) license

ISSN 2703-7525

Publisher: Septentrio Academic Publishing, Tromsø, Norway

Table of Contents

1	Motivation	8
2	Labelling of samples and data from cruises within the Nansen Legacy project	8
2.1	Standardized metadata.....	10
2.2	The UUID generator.....	10
3	Transects, process stations, and mooring sites.....	13
3.1	Brief description of the process study stations	13
3.2	Standardized Sampling depths during the Nansen legacy cruises.....	15
4	Bridge-based observations	16
4.1	Ice observations	16
5	Underway sensors/measurements.....	17
5.1	Surface water partial pressure of CO ₂ (pCO ₂).....	17
5.2	Surface water dissolved oxygen.....	17
6	Water column structure.....	18
6.1	CTD	18
6.2	Niskin Rosette.....	22
6.3	ADCP.....	23
6.4	In situ primary production and photosynthesis depth profile using FRRf.....	25
6.5	Water inherent optical properties measurements.....	26
6.5.1	Absorption and scattering profile	26
6.5.2	Volume scattering function profile.....	29
7	Water samples from Niskin bottles.....	31
7.1	Salinity samples.....	31
7.2	Sampling of DIC, AT and pH.....	31
7.2.1	Total dissolved inorganic carbon (DIC)	31
7.2.2	Total alkalinity (AT)	32
7.2.3	pH.....	33
7.3	Sampling for $\delta^{18}\text{O}$ (delta-O-18).....	34
7.4	Particulate Organic Carbon (POC) and Nitrogen (PON)	36
7.5	Total (TOC) and Organic Carbon	38
7.6	Dissolved organic matter characterization (DOM/C).....	39
7.6.1	DOC/TDN-quantification.....	43

7.7	Trace Elements sampling via GO FLO bottles.....	45
7.7.1	Mercury sampling via GO FLO bottles	46
7.8	Sampling and determination of cDOM absorption	48
7.8.1	Sampling for CDOM	48
7.8.2	Measurement of CDOM absorbance	51
7.9	Collection of particle concentration samples.....	55
7.10	Collection of particle absorption samples	57
7.11	Particulate element concentration using xrf.....	59
7.12	Inorganic nutrients	62
7.13	Water column sampling for algal pigment concentrations (chlorophyll <i>a</i> , phaeopigments)	63
7.13.1	Measurements of algal pigment concentrations (chl <i>a</i> , phaeopigments) based on samples from water column and sea ice	66
7.14	Concentrating protists <10 µm by VivaFlow filtration	69
7.15	Light microscopy phytoplankton/protists.....	72
7.16	Light microscopy large protists/rare taxa.....	74
7.17	Metabarcoding (DNA and RNA) of protists and prokaryotes	76
7.18	Metatranscriptomics (mRNA) of protists and prokaryotes.....	80
7.19	Filtration for DNA/RNA samples using 0.22 µm Durapore filters	84
7.20	Flow cytometry sampling.....	85
7.21	Bacterial biomass production	87
7.22	Iron Chloride Precipitation of viruses from seawater	88
7.23	Viral production and decay (Rev.1).....	94
7.24	Coccolithophores and other small plankton for SEM	97
7.25	Microalgal diversity by culturing (serial dilutions)	99
7.26	Determination of <i>in situ</i> Primary Productivity Rate \ using the 14C method...	101
7.27	Determination of Primary Productivity Rate in Relation to Light Intensity (P vs I curves) using the ¹⁴ C method	106
7.28	Measuring Photosynthesis using Phyto-PAM.....	112
7.29	Phytoplankton Pigment Anlasys (HPCL).....	114
7.30	Phytoplankton cell size and health using Cyto-Sense	116

7.31	Water sampling for Benthic experiments (Niskin rosette)	117
7.32	Microbial/Particles Experimental design.....	118
7.32.1	Grazer-exclusion experiment.....	118
7.32.2	Aggregation experiment.....	122
8	Short-time drifting Sediment traps	124
9	Net sampling.....	126
9.1	Phytoplankton net haul sampling.....	126
9.1.1	Microalgal diversity by culturing (capillary isolation).....	129
9.1.2	Protist diversity by single cell PCR.....	131
9.2	Zooplankton sampling	133
9.2.1	Mesozooplankton.....	133
9.2.2	Macrozooplankton abundance, biomass & genetics	142
9.2.3	Zooplankton acoustics EK80	145
9.2.4	Mesozooplankton & macrozooplankton for ecotox, stable isotopes & fatty acid samples.....	149
9.2.5	Stable isotopes, Fatty acids & Highly branched isoprenoids (HBIs).....	150
9.3	Zooplankton experimental design.....	154
9.3.1	Two-point dilution experiment.....	154
9.3.2	Measurements of respiration of Calanus species.....	158
9.3.3	Experimental protocol for copepod egg incubations to determine secondary production and grazing experiment	162
9.3.4	Calanus exposure experiment.....	169
9.4	Zooplankton manuals	171
9.4.1	Multinet manual	172
9.4.2	MIK	175
9.4.3	Macroplankton trawl.....	176
9.4.4	WP2, WP3 & Bongo net manual	177
10.	Benthic sampling.....	181
10.2	AeN team members interested in benthic invertebrate samples and seabed sediment samples	181
10.3	Benthic sampling gear.....	183
10.3.1	Galvanize steel beam trawl (Figure 10.2 – 1 A,B).....	185
10.3.2	Box corer (Figure 10.2 – 1 E).....	185

10.3.3	Campelen 1800 with Rockhopper ground-gear trawl (10.2 – 1 C,D)	186
10.3.4	Gemini corer (Figure 10.2 – 1 F)	187
10.3.5	van Veen Grab (back up to Box corer) (Figure 10.2 – 1 E)	187
10.4	Sediment and benthic invertebrate sampling	190
10.4.1	Sediment pigments (Box corer sampling)	192
10.4.2	Benthic chlorophyll a/phaeopigments (Box corer sampling)	193
10.4.3	Sediment grain size and sediment carbon, nitrogen and stable isotopes (Box corer sampling)	194
10.4.4	Sediment microbes (Box corer sampling)	195
10.4.5	Foraminiferal community and metazoan meiofauna community (Box corer sampling)	196
10.4.6	Biogenic Silica (Box core sampling)	197
10.4.7	Diatom spores (Box core sampling)	198
10.4.8	Benthic respiration and uptake experiments (Box corer sampling)	199
10.4.9	Quantitative macrofaunal assemblage (Incubation cores from Box corer sampling)	201
10.4.10	Incubation cores from Box corer sampling: Quantitative foraminiferal assemblage	202
10.4.11	Quantitative epibenthic megafauna (Beam trawl & Campelen trawl)	203
10.4.12	Stable carbon and nitrogen isotope analysis of benthic infauna and epifauna	205
10.4.13	Sampling for diet assessments of small invertebrates	207
10.4.14	Sampling of <i>Pandalus borealis</i> for molecular analyses	212
10.5	Nansen Legacy collection at the Arctic University Museum of Norway	215
10.6	Sediment Extraction for trace elements	216
10.7	Dark DIC uptake in sediments	217
11.	Fish	219
11.2	Fish trawling/sampling of polar cod, atlantic cod and capelin by demersal and pelagic trawl	222
11.3	Fish stomach sampling	224

11.4	Fish dissection/biological sampling for polar cod, atlantic cod and capelin – genomic studies.	225
11.5	Precision-Cut liver slice (PCLS) preparation and culture for fish.....	228
11.6	Sampling of bile and blood of Arctic fish	231
12.	Marine mammals	234
13.	Ecotoxicological samples.....	235
13.2	Water sampling	236
13.2.1	POPs – Persistent Organic Pollutants	236
13.2.2	PFAS – perfluorinated alkylated substances	240
13.3	Zooplankton sampling	241
13.4	Fish sampling.....	244
14.	Sea ice work	249
14.2	Safety brief.....	249
14.3	Selection of the ice floe	249
14.4	Data logging and preparation prior to Ice station	251
14.4.1	Data logging and labelling.....	251
14.4.2	Ice working teams and tentative plan.....	251
14.4.3	Sea ice work equipment	256
14.4.4	After sea ice sampling.....	257
14.5	Sea ice transmittance and albedo determination	257
14.6	Snow depth and ice thickness survey	260
14.6.1	Snow sampling.....	261
14.7	Ice hole for deployment of in situ incubations/sediment traps and Under-ice water sampling	262
14.7.1	Under-ice water sampling	263
14.7.2	Melt pond sampling	265
14.8	Sampling of ice cores.....	265
14.8.1	Ice core sampling, cutting scheme and ice core parameters	266
14.8.2	Sea ice samples for iron and other trace elements	283
14.8.3	Sea ice sampling for mercury	285
14.8.4	Sea ice meiofauna	287
15.	Geological sampling	289
15.2	Sediment sampling	290

15.2.1	Short sediment cores (2 ka) – Multicorer	290
15.1.2	Long sediment cores (14ka) – gravity/calypso corer	301
15.2	Geological Water sampling	302
15.2.1	Geology proxy development of stable isotope analysis	302
16	Methods guest researchers and previous cruises	306
16.1	TOC, TN, TS, C/N ratios, Fe speciation	306
16.1.1	CTD sampling for nutrients and ICP analysis	306
16.1.2	Multicore sampling.....	307
16.1.3	Gravity core sampling	310

For å lykkes på isen trengs det bare to ting, gode klær og meget mat.
Fridtjof Nansen

1 Motivation

The collection of detailed sampling protocols is crucial tool for the success of the *Nansen Legacy*, because they ensure:

- Methodological agreement between the involved researchers
- Continuity and comparable data throughout the 5 years sampling period
- An easily accessible overview over parameters sampled
- Easier cruise planning

Please forward any request/feedback/input/update for the sampling protocol to Miriam Marquardt (UiT, miriam.marquardt@uit.no).

2 Labelling of samples and data from cruises within the Nansen Legacy project

Method responsible: Luke Marsden (data.nleg@unis.no)

To secure a FAIR (Findable, Accessible, Interoperable, Reusable) data management within the project, a first step is to ensure that the collected samples are findable and that relevant metadata are logged along with the sample collection. The metadata need to be logged in a standardized manner and will be made accessible through a search interphase as soon as possible after the cruises.

To help cruise and project participants keep track of their samples, a system where each sample is given a unique ID (a **UUID; Universally Unique ID**) has been developed. The UUID will follow each sample and is printed as a Data Matrix code on sticker labels which are placed on the sampling containers. The value of the Data Matrix (see Fig. 2-1) is read by hand-held scanners or cellphones and automatically written into an excel sheet along with sample metadata. This allows for easy tracking of the samples using the Data Matrix.

Sampling within the project is to a large degree hierarchical, where we use a sampling gear (for instance a MIK net) which is subsampled to measure different parameters (community composition, sample biomass, single species collection etc). It is essential to be able to trace the individuals back to the sampling gear, station and cruise, and the UUID system used facilitates this through a hierarchical parent/child ID. The sampling gear is given a UUID which is used to trace all subsamples taken from that one gear deployment. A subsample taken from the

gear is given another UUID, but at the same time it is referred back to the parent UUID. Any sample taken from the subsample is given another UUID, and refers back to its parent (that is, the subsample UUID) as described in Fig. 2-1. Thus, we only need to keep track of two hierarchical levels of UUIDs for every sample but will be able to trace all samples back to sampling gear and the relevant metadata (station ID, cruise ID etc.) through the family tree.

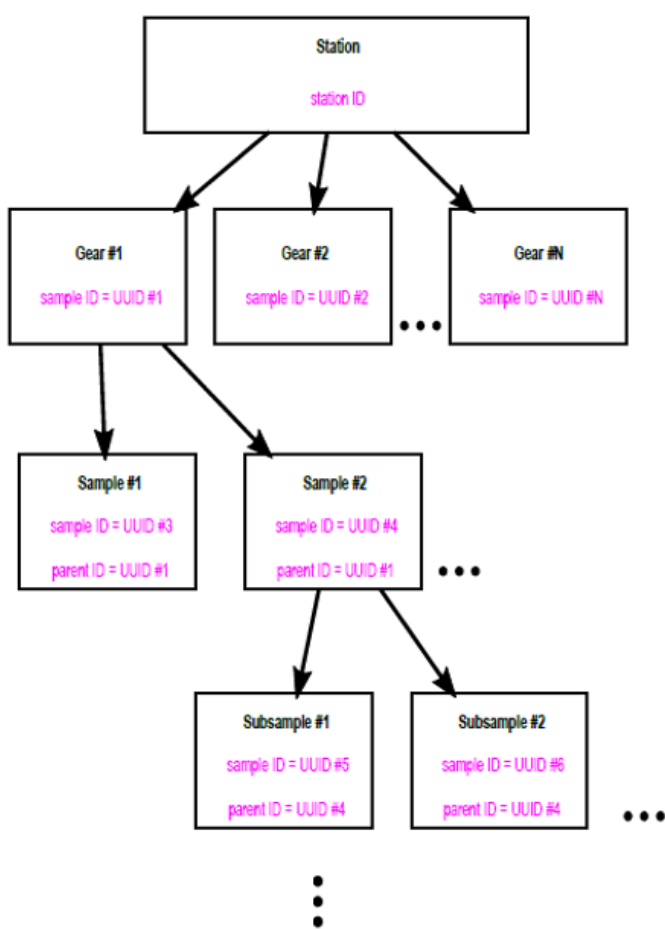

Fig. 2-1 The hierarchical system with sample/subsample IDs used to trace samples and data within the project.

UUID, version 1 is saved as a Data Matrix:



Value: f78d2bfa-8053-11e8-b4dd-a0481c9e7d26

2.1 STANDARDIZED METADATA

The metadata (and later on the data) needs to be logged according to accepted standards using a controlled vocabulary to allow for compatibility with the databases where our metadata and data will be made findable and accessible. We will use the Darwin Core standard wherever it is available for the biological/chemical/palaeontological data, and the NetCDF/CF standard for physical data. To build up an excel sheet where the standardized formats are used for the required metadata information, an excel template generator has been made available through the **SIOS webpage**:

<https://sios-svalbard.org/cgi-bin/darwinsheet/index.cgi>

During the 2018 cruises with “Kronprins Haakon” it will also be available on the **ships internal network**:

<http://10.3.65.20/cgi-bin/darwinsheet/index.cgi>

The required fields needed to log for every sample and subsample collected within the project is already selected in the excel template generator, and extra fields that may be relevant for different samples and where a controlled vocabulary already exists can be added (which is recommended to do). The required fields include a minimum of metadata information necessary, and most of this information can be taken directly from the screens/cruise logger onboard KPH. The excel sheet is set up to control the content of the cells, and thus it is not possible to write information in a wrong format (e.g. the date has to be written as YYYY-MM-DD). The generated excel sheet can be added additional fields which individual researchers want to log for their own samples. All the parameter definitions are explained in the excel template generator (when the mouse is held over the term), and there is also an explanation for the different parameters in the individual cells of the generated excel sheets.

2.2 THE UUID GENERATOR

In some cases, it is necessary to generate a UUID for a sample or a subsample which is not kept. This could for example be the sampling gear UUID in cases where all samples collected from the sampling gear represent unique subsamples and are labelled with their subsample ID. In such cases, UUIDs can be generated through the UUID generator:

KPH internal network: <http://10.3.65.20/cgi-bin/darwinsheet/uuid.cgi>

SIOS portal: <https://sios-svalbard.org/cgi-bin/darwinsheet/uuid.cgi>

The UUID is copied into the excel sheet, but there is no labelled sample with the UUID.

Printing of sample labels:

Sample labels can be printed in different sizes and label qualities depending on sample type. All labels must include the UUID which is printed as a Data Matrix using label printers. The label printers can be accessed here:

<http://10.3.65.20/cgi-bin/darwinsheet/print.cgi> (via the KPH internal network).

We recommend that sampling containers are also labelled according to individual researchers' standard procedures, so that it is possible to identify them also without scanning the Data Matrix.

- **Small labels** – the smallest sized labels include only the Data Matrix on small stickers that can be added to e.g. Eppendorf lids. These labels must be put on a flat surface to allow the Data Matrix to be scanned. These are most relevant to use with pre-labelled small tubes, in particular in cases where many samples are collected from the same sampling gear/subsample.
- **Medium-size labels** – these labels include the possibility of adding four lines of written information to ease the identification of the samples without scanning the Data Matrix.
- **Large labels** – these labels are used for labelling of larger samples.



Fig. 2.2-1 (left) Medium-sized labels with the possibility of adding sample information in addition to the Data Matrix.

Fig. 2.2-2 (right) Setup showing one of the label printers, a scanner, and the small and medium-sized labels with printed Data Matrix codes.



Reading of sample labels:

Sample labels can be read with barcode scanners and mobile apps, as well as webcamera. At 1'UNIS and UiT there is an opticon scanner available:

- Opticon Sensor OPI-3601 (e.g. <https://shop.itello.no/opticon-sensors-opi-3601->

3 Transects, process stations, and mooring sites

The Nansen LEGACY transect and stations are defined below. It consists of 25 stations (of which 7 are defined as process study stations) covering the northern Barents Sea from south of the Polar Front to the Arctic Ocean (Fig. 3.1-1). Which, and how many of the stations that will be conducted on each Nansen LEGACY survey will vary among the surveys depending on ship time, sea ice conditions and focus of the survey.

Location of the process study stations are motivated by 1) they should cover both Arctic and Atlantic conditions for comparison, 2) some of them should have sediment conditions suitable for geological coring, and 3) some of them should have moorings to get data throughout the year (for seasonality).

Location of the main RF1 moorings (M1-M4) are motivated by the need of measuring the flow of Atlantic Water into the northern Barents Sea. These moorings will be deployed in 2018 and will be extensively equipped with instrumentation measuring the properties of the inflowing Atlantic Water as well as the rest of the water column. The process study stations to study the Arctic species must be placed at locations dominated by Arctic conditions. Moorings will be deployed at some of the locations in 2019 to obtain year-round time series at the Arctic process study sites.

3.1 BRIEF DESCRIPTION OF THE PROCESS STUDY STATIONS

P1 – located in Atlantic Water south of the Polar Front. P1 is suitable for comparing the Atlantic Water dominated, southern Barents Sea with the Arctic Water, dominated northern Barents Sea. P1 is likely to be free of sea ice during most of the winter. Being in a deeper trench, P1 is expected to have suitable sediments for geological coring.

P2 – located at the central/northern part of Storbanken in a region which usually have Arctic conditions in the intermediate part of the water column. P2 is likely to have varying sea ice coverage during winter, and a moderate surface layer of meltwater during summer.

P3 – located in the trench north of Storbanken. P3 will likely be characterized of Arctic conditions in the upper part water column and a deep northeastward flow of Atlantic Water (from the branch entering the southern Barents Sea) in the lower part of the water column. P3 is likely to have varying sea ice concentration during

winter, and a surface layer of meltwater during summer. Being in a deeper trench, P3 is expected to have suitable sediments for geological coring.

P4 – located in the deeper trench south of Kvitøya. P4 will likely be characterized of Arctic conditions in the upper part water column and a deep southwestward flow of Atlantic Water (from the branch going around Svalbard) in the lower part of the water column. It is expected that P4 will be covered with sea ice most of the winter, and by a surface layer of meltwater during summer. Being in a deeper trench, P4 is expected to have suitable sediments for geological coring.

P5 – located on the shallow shelf northeast of Kvitøya. P5 is likely to have Arctic conditions below the seasonal varying surface layer. It is expected that P5 will be covered with sea ice most of the winter, and by a surface layer of meltwater during summer.

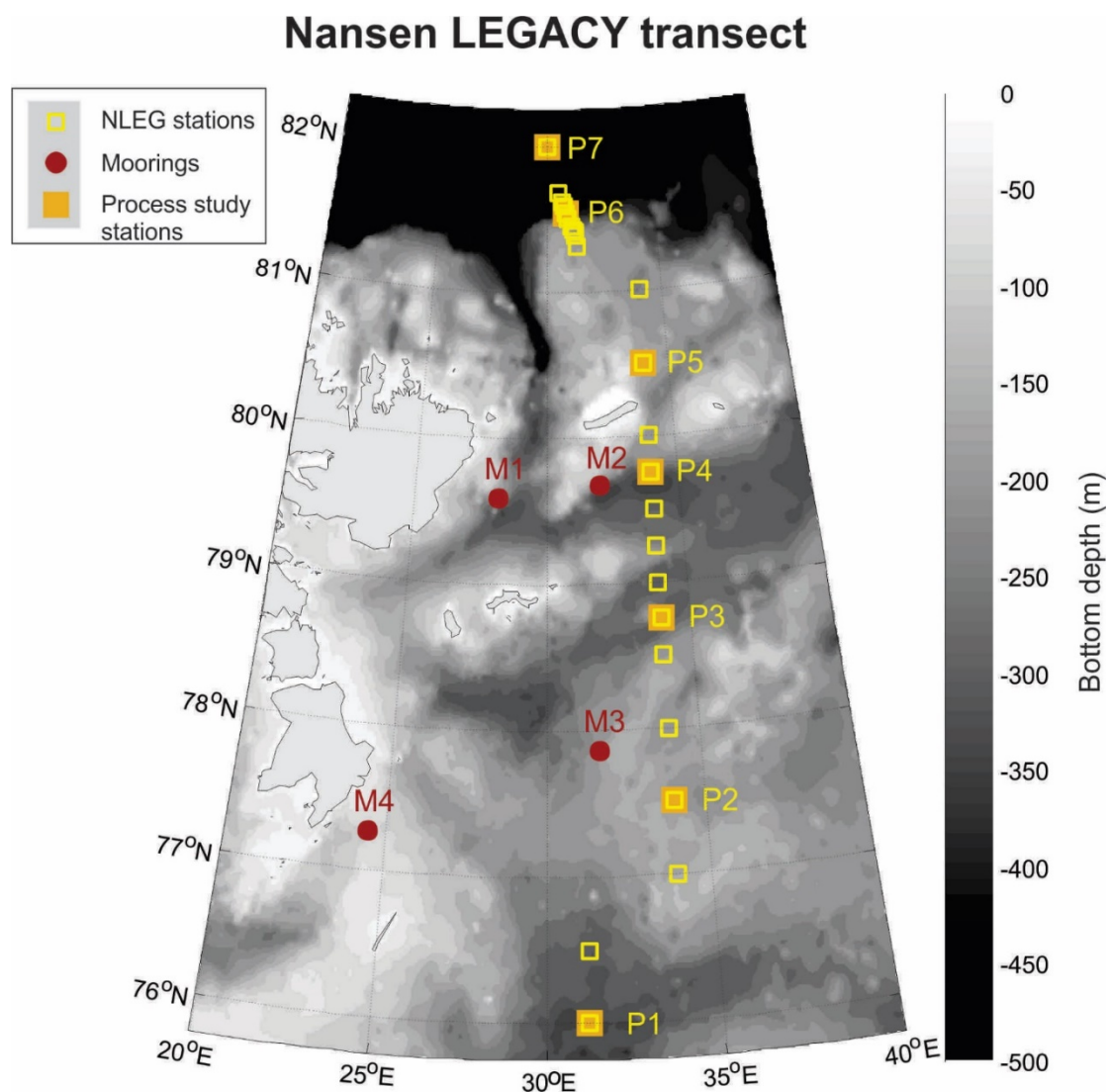

Fig. 3.1-1 Map of the Nansen LEGACY process study stations (P1-7) and transect (yellow squares) and mooring locations (red dots, M1-4).

P6 – located at the shelf-break slope (at about 850m) towards the Arctic Ocean. P6 is situated in the core of the Atlantic Water flow in the shelf-break current. It is expected that P6 will have a varying sea ice cover during winter, and a varying surface layer of meltwater during summer. ATWAIN-moorings (not shown in map) can provide year-long measurements for P6. P6 might be suitable for geological coring.

P7 – Located in the deeper Arctic Ocean. P7 is suitable for comparing the shallow Barents Sea with the deeper Arctic Ocean. P7 will have extensive sea ice coverage during winter, and varying sea ice cover during summer. P7 might be suitable for geological coring.

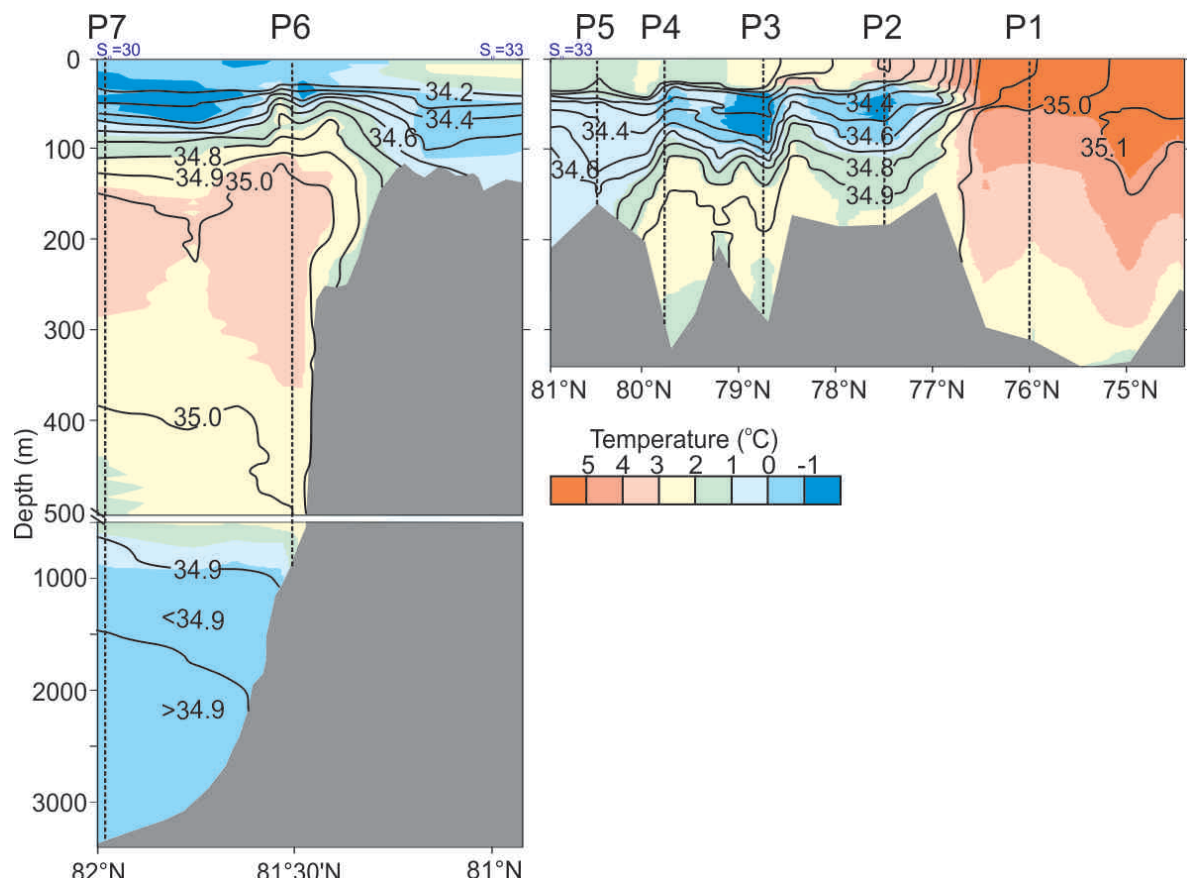

Fig. 3.1-2 Temperature (color) and salinity (black solid lines) distribution in the Nansen LEGACY transect sampled in August 2012. Note different scales on the horizontal axes. The location of the process study stations (P1-7) is shown with dashed vertical lines.

Nansen LEGACY transect - stations

Station name	Longitude (decimal)	Latitude (decimal)	Longitude (degrees)	Latitude (degrees)	Depth (m)	Type of station	Comment
NLEG25	30,0000	82,0000	030 00.00 E	82 00.00 N	3000	Process station P7	study
NLEG24	30,5258	81,6828	030 31.55 E	81 40.97 N	2807		<i>A-TWAIN</i>
NLEG23	30,6647	81,6165	030 39.88 E	81 36.99 N	1913		<i>A-TWAIN</i>
NLEG22	30,7667	81,5895	030 46.00 E	81 35.37 N	1551		<i>A-TWAIN</i>
NLEG21	30,8548	81,5463	030 51.29 E	81 32.78 N	865	Process station P6	study <i>A-TWAIN, shelf-break</i>
NLEG20	30,9618	81,5025	030 57.71 E	81 30.15 N	698		<i>A-TWAIN, shelf-break</i>
NLEG19	31,0775	81,4580	031 04.65 E	81 27.48 N	486		<i>A-TWAIN, shelf-break</i>
NLEG18	31,1448	81,4318	031 08.69 E	81 25.91 N	264		<i>A-TWAIN, shelf-break</i>
NLEG17	31,2468	81,4107	031 14.81 E	81 24.64 N	204		<i>A-TWAIN, shelf-break</i>
NLEG16	31,2933	81,3822	031 17.60 E	81 22.93 N	189		<i>A-TWAIN, shelf-break</i>
NLEG15	31,3487	81,3098	031 20.92 E	81 18.59 N	195		<i>Arctic Price near-shelf-station</i>
NLEG14	34,0000	81,0000	034 00.00 E	81 00.00 N	216		<i>Vardø-N, Kvitøybanken</i>
NLEG13	34,0000	80,5000	034 00.00 E	80 30.00 N	167	Process station P5	study <i>Vardø-N, Kvitøybanken</i>
NLEG12	34,0000	80,0000	034 00.00 E	80 00.00 N	209		<i>Vardø-N, Kvitøybanken</i>
NLEG11	34,0000	79,7500	034 00.00 E	79 45.00 N	332	Process station P4	study <i>Vardø-N, trench east of Kong Karl</i>
NLEG10	34,0000	79,5000	034 00.00 E	79 30.00 N	293		<i>Vardø-N, trench east of Kong Karl</i>
NLEG09	34,0000	79,2500	034 00.00 E	79 15.00 N	215		<i>Vardø-N, trench east of Kong Karl</i>

NLEG08	34,0000	79,0000	034 00.00 E	79 00.00 N	266			<i>Vardø-N, trench east of Kong Karl</i>
NLEG07	34,0000	78,7500	034 00.00 E	78 45.00 N	301	Process station P3	study	<i>Vardø-N, trench east of Kong Karl</i>
NLEG06	34,0000	78,5000	034 00.00 E	78 30.00 N	180			<i>Vardø-N, Storbanken</i>
NLEG05	34,0000	78,0000	034 00.00 E	78 00.00 N	193			<i>Vardø-N, Storbanken</i>
NLEG04	34,0000	77,5000	034 00.00 E	77 30.00 N	190	Process station P2	study	<i>Vardø-N, Storbanken</i>
NLEG03	34,0000	77,0000	034 00.00 E	77 00.00 N	154			<i>Vardø-N, Storbanken</i>
NLEG02	31,2200	76,5000	031 13.20 E	76 30.00 N	308			<i>Vardø-N, Storbanken</i>
NLEG01	31,2200	76,0000	031 13.20 E	76 00.00 N	322	Process station P1	study	<i>Vardø-N, Hopen djupet</i>

3.2 STANDARDIZED SAMPLING DEPTHS DURING THE NANSEN LEGACY CRUISES

All sampling should take place at the assigned standardized sampling depths:

- 5, 10, 20 m
- DCM (Deep Chla max: only if present and significantly different from standard depths, i.e. ± 5 m)
- 30, 40, 50, 60, 90, 120, 150/200, Bottom-10
- In addition to the following at the deep stations: 500, 1000, 1500, 2000, 3000, 4000 m (depending on station depths, will be decided onboard)

4 Bridge-based observations

4.1 ICE OBSERVATIONS

<http://www.climate-cryosphere.org/media-gallery/881-icewatch-assist>
→ Photos can be uploaded in the software directly.

ICE WATCH Home of the ASSIST Data Network

IARC's Ice Watch Program is an open source forum to monitor in situ Arctic sea ice conditions. It provides convenient resources to utilize the Arctic Shipborne Sea Ice Standardization Tool (ASSIST) and access current and historic shipborne Arctic sea ice observation data.

- Learn about the international effort to develop the Ice Watch program and ASSIST tool
- Access near real-time data collected on cruises participating in Ice Watch
- Retrieve past observations via the IARC Data Archive
- Upload and view data in map view with latest satellite imagery and statistical plots
- Download the ASSIST software to record shipborne observations

ASSIST Arctic Shipborne Sea Ice Standardization Tool

The ASSIST software program is a standardized protocol for collection of visual sea ice, meteorological, and sea surface observations from ships traversing ice-covered marine waters in the Arctic.

- Record, edit, and report full shipborne observations with Windows, Mac, or Linux OS
- Compatible with the World Meteorological Organization (WMO) sea ice nomenclature, Ice Egg Code, and Antarctic Sea Ice Processes & Climate (ASPeC)
- Supports metadata, photo uploads, and additional comments for all cruise observations
- Multiple format output data for visualization, analysis, or sharing via the IARC Data Archive

Photographs and additional comments can be linked to each observation

Record details of the Primary, Secondary, and Tertiary ice types for each observation

Topography data input for each ice type is optional. Fields allow the observer to describe the area the feature covers, and for ridges the height and whether the ridges are old, consolidated and/or snow covered.

Melt pond data input is optional. Fields characterize the melt pond cover (concentration), whether ponds are linked or discrete, mean freeboard and depth of ponds.

Meteorological data input required for Visibility. General weather conditions and cloud details are optional.

All of the ship tracks and ice observation data recorded with ASSIST during the 2012 field season, layered on the AMSR2 sea ice minimum extent image. Selecting one of the ship names from the 2012 Cruises menu will access the respective data set along with map visualizations and plots from a statistical analysis of Concentration and Ice Types.

The 2012 IceArc cruise data collected aboard the Polarstern. Time series of the concentration, with colors representing old, first year and new ice.

The percentage of each Ice Type record along the 2012 IceArc cruise aboard the Polarstern. (Thanks to Alfred Wegener Institute's Marcel Nicolaus, Stefan Heedricks, and 26 other observers.)

Fig. 4.1-1 Introduction to commonly used ice observations by <http://www.climate-cryosphere.org/media-gallery/881-icewatch-assist>

5 Underway sensors/measurements

5.1 SURFACE WATER PARTIAL PRESSURE OF CO₂ (PCO₂)

Measured parameter: mole fraction of carbon dioxide (xCO₂), partial pressure of CO₂ (pCO₂, μ atm) and fugacity of CO₂ (fCO₂ (μ atm))

Method responsible: Agneta Fransson (NPI, agneta.fransson@npolar.no) and Melissa Chierici (IMR, Melissa.chierici@hi.no)

Description of parameter: Partial pressure of CO₂ is the dissolved CO₂ in seawater and atmosphere.

Method description:

Surface water xCO₂ (or pCO₂, fCO₂) is continuously measured from the ships' seawater intake at 4 meter using the instrumentation of General Oceanics® (showerhead equilibration and dispersed infrared detection). Discrete water samples are collected regularly to be analysed regarding DIC and AT (see section [7.2](#)) for quality control of the instrument data. Measurements of atmospheric pCO₂ are performed during a 24-hour cycle. A set of four standard gases of different CO₂ concentrations (0, 350, 450, 600 μ atm) are analysed in the 24-hour cycle and used for calibration of the measurements. Seawater salinity and temperature are measured by a TSG Seabird sensor and will be logged by the pCO₂ instrument and used in the calculations of pCO₂.

5.2 SURFACE WATER DISSOLVED OXYGEN

Measured parameter: dissolved oxygen (DO, O₂ μ mol/kg)

Method responsible: Agneta Fransson (NPI, agneta.fransson@npolar.no) and Melissa Chierici (IMR, melissa.chierici@hi.no)

Description of parameter: Dissolved oxygen is the oxygen gas dissolved in seawater.

Method description:

Dissolved oxygen is continuously measured from the ships' seawater intake at 4 meter using an Optode from Aanderaa®. Oxygen concentration, saturation and water temperature are logged in the pCO2 data log.

6 Water column structure

6.1 CTD

General requirements:

As of 26 July 2018, the KPH CTD is equipped with double set of temperature and conductivity sensors, pressure sensor, oxygen and fluorescence sensors, and an altimeter. To be installed are a turbidity and a PAR sensor.

Annual calibration of all CTD sensors (in particular T, S, and O2) should be documented through calibration sheets available on request. Samples for calibration of the conductivity cell(s) should be taken regularly during a research cruise covering the observed salinity range. This might require several samples per CTD cast.

Setup of the CTD and postprocessing follows standard IMR routines. Raw data (ie .hex-files and configuration files) should be available for own postprocessing e.g. in case conversion to other units or different depth bins is required, or LADCP postprocessing requires lat&lon information throughout the cast.

If LADCPs are mounted on the rosette, GPS position from the NMEA feed should be recorded throughout the cast: in Seasave, choose the setting to append lat&lon to every scan. As of 26 July, this setting was in place.

Metadata of the cast should be recorded in the CTD file and on the CTD sampling sheet.

Information to be logged:

For each cast, information to be noted down:

- date & time (UTC)
- position at start, bottom, and end
- bottom depth (in meter)
- operator
- ship
- sensor type incl. serial number for each component
- software used e.g. for SBE instruments incl version number
- meteorological conditions (barometric air pressure at sea level, wind speed & direction (degrees), air temperature (deg C), cloud cover (in 10th))

In case of extensive water sampling of CTD casts, a sampling log sheet should be used for overview of type of water sample taken and sample number (see Appendix for template).

Deployment routines:

- Start data acquisition just before the CTD leaves the deck (this will help with assessing surface pressure adjustment).
- Soak for 1 minute at 5 m (10 m if very cold and there is a risk of freezing during deployment or on deck), bring back up to surface (ie. just submerged, rosette/CTD frame not breaking through the sea surface), leave there for 3 minutes.
- Lower CTD to max depth. Rest at max depth for at least 1 minute (preferably longer).
- Lowering speed: between 0.8 and 1 m/s. If LADCP is mounted, 0.7 m/s. Take care not to hit the bottom with the CTD but stop 5-10 m above ground, depending on conditions (steepness of topography, drift speed of the ship). Use the altimeter on the CTD to assess distance to bottom.
- Depending on capacity for measuring salinity samples onboard, water samples should be taken at various depths throughout the CTD cast. Suggested minimum number of samples is 3 – one at bottom/max depth, one in the middle of the water column in a region without strong salinity gradient, and one in the surface mixed layer. More samples will improve accuracy of the calibration. Depth should be chosen to cover the range of salinities and pressure throughout the cast/cruise.
- If water samples for other variables are taken at standard depths (e.g. following protocols from the Nansen Legacy project, salinity samples can be taken at some of those depths.
- If salinity samples are measured throughout the cruise, at least 5 samples should be taken from each cast.

- Close Niskin bottles on upcast: stop CTD at sampling depth (do NOT fire “on the fly!”), wait at least 1 minute, preferably 2 minutes, then fire Niskin bottle. Flushing time (i.e. wait before closing the bottle) should be longer in calm conditions and for big rosette systems or Niskin bottles with small openings.
- Fill in depths of the bottles on the log sheet and send the log sheet to the CTD sampling crew as soon as possible.
- Stop data acquisition when the CTD is back on deck.

Special deployment routines for use in Moonpool:

- Lower with cursor
- Wait until the pump starts
- Lower to wanted depth. Make precautions to not hit the bottom
- For closing bottles at 10 m; start at 11 m on the fly (if several are to be released).
Manage 5 bottles from 11 – 10 m
- The last can be closed in cursor

→ Routine made to avoid damage to CTD while hanging under the vessel in rough sea

CTD log sheet template

Cruise:	Date/Time:
CTD #:	Station name:
Bottom depth:	Observer:
Latitude:	Longitude:
Comments:	

Niskin #	1	2	3	4	5	6	7	8	9	10	11	12
Depth (m)												
Ct/At												
18O												
CDOM												
TOC												
DMSP												

Nutrients												
Ammonium												
Salinity												
Chl a												
POC/PON												
TPP												
FCM												
SEM												
XRF												
BP												
DNA												
Casy												

Niskin #	13	14	15	16	17	18	19	20	21	22	23	24
Depth (m)												
Ct/At												
18O												
CDOM												
TOC												
DMSP												
Nutrients												
Ammonium												
Salinity												
Chl a												
POC/PON												
TPP												
FCM												
SEM												
XRF												
BP												
DNA												
Casy												

6.2 NISKIN ROSETTE

If many different groups sample water from the rosette, use the CTD log sheet for overview of Niskin bottle depths, sampling order, and sample numbers.

Taking water samples for salinity calibration:

- Use appropriate sample bottle! With plastic insert.
- Rinse bottle and bottle cap (but not insert) three times. Dry off bottle neck (in- and outside) and cap with paper towel before closing the bottle. Pay special attention to the thread on the bottle and in the cap.

- Note down on the sampling log cast number/station number, Niskin bottle number, sample bottle number.
- IMR have a registration system for salinity samples, make sure the information is entered there.

For the winch drivers on deck:

- Check that wire length corresponds with CTD depth – give information about depths as necessary if there is a difference. As of 26 July, the wire length was increasingly too short, indicating a need for calibration on the measuring wheel.
- When bringing the CTD back on deck in CTD hangar, the CTD needs to be moved further in than the winch does automatically, otherwise there is not enough space around the rosette for sampling.

6.3 ADCP

General requirements:

There are four ADCPs mounted: two 38 kHz and two 150 kHz RDI Ocean Surveyors. One of each are located on a drop keel, the other ones are in the hull (aka Arctic window aka flush mounted). There are two PCs to control them, one per frequency, dual boot to reach drop keel or flush mounted instrument.

→ You can run only one of the 150kHz and one of the 38kHz together, but not both 150kHz or both 38kHz ADCPs.

You can access the PCs from any of the work stations in the instrument room, use shift-shift-o to change between computers.

Something to remember:

If you want to use the 38 kHz, turn off the 38 kHz frequency of the EK80. Likewise, if the EK80 takes priority, do not use the 38 kHz ADCP, there is significant interference both ways.

Configuring the ADCPs:

Configuration files for standard setup are stored in a folder on the desktop on each PC/boot.

There are 2x4 configuration files to cover:

- Narrowband versus Broadband
- Bottom track on versus off
- Synchronization through the K-Sync unit or standalone pinging.

Default setup should be:

- for ADCP only use: Narrowband, bottom track on;
- for concurrent ADCP/EK80 use: Narrowband, bottom track off.

In both cases:

- For 38 kHz ADCP: bin depth = 24 m, 16 m blanking distance, 65 bins
- For 150 kHz ADCP: bin depth = 8 m, 4 m blanking distance, 65 bins

Some of the settings in the configuration files might need adjusting:

Draft of the boat:

- Varies between minimum 7.2 m and maximum 8.5 m → check on bridge and adjust in the configuration files (command: ED).
- Might need adjusting during a cruise if ballasting changes significantly, so check draft regularly.
- If drop keel is extended, add the additional draft (max 3.4 m) → display in instrument room. There should be an event log when the drop keel is deployed and taken up again.
- Set salinity to something sensible. It's set to 35 in the configuration file - adjust there if needed (command: ES)

→ NOTE: Make a copy of the standard config files and do the changes in the copy!

The rest of the configuration and starting and stopping of the ADCPs are done in VmDas. An extensive guide for VmDas settings is available on the ADCP PCs. Contact the instrument technicians for help.

6.4 IN SITU PRIMARY PRODUCTION AND PHOTOSYNTHESIS DEPTH PROFILE USING FRRF

Measured parameters: Photosynthetic parameters of photosystem II

Method responsible: Natalie Summers (NTNU: natalie.summers@ntnu.no), Geir Johnsen (NTNU: geir.johnsen@ntnu.no)

Description of parameters: In situ fluorescence-kinetics of phytoplankton photosynthetic parameters, based on Chl-a fluorescence from PSII characteristics using FRRf (Fast Repetition Rate fluorometer).

Methodological description:

→ **Special requirements/gear:** Deploy at CTD rosette for the water column structure or winch in ice hole

→ **Sampling depths:** surface to Chl-a max depth

Preparation:

- Charge battery overnight
- Connect to laptop to set protocols
- Replace all the dummy plugs and check everything is securely screwed on
- Place in a large sink with freshwater to test that everything is watertight
- Tune software to major pigment group of phytoplankton (if possible)

Deployment:

- From the side of the ship (same as CTD) or with winch in ice hole (ice station)
- Attach the frame to a winch/ CTD or a crane for a vertical deployment of the system
- When ready for deployment, turn on the system using remote
 - First, turn the pump on
 - Turn on FRRF
- Immerse into water
 - Slow descent: 0.3m/sec

- Stop 2-5min at 5m
- Stop 2-5 min at Chl a max
- Can go deeper but light sensor not sensitive in low light
- Bring system up and turn off
- Repeat profile 3 or 4 times
- Put in a freshwater sink with the pump on for a few minutes

6.5 WATER INHERENT OPTICAL PROPERTIES MEASUREMENTS

6.5.1 Absorption and scattering profile

Measured parameters: Hyperspectral measurements of the following Inherent Optical Properties (IOPs) in the visible: absorption and attenuation

Method responsible: Tristan Petit (RF1: NPI, Tristan.petit@npolar.no), Børge Hamre (RF1: UiB, borge.hamre@uib.no), Mats Granskog (RF1: NPI, mats.granskoog@npolar.no)

Description of parameter: Light absorption is a transformation of light (photons) into another form of energy. Light attenuation includes absorption as well as scattering (deviation of light) which increases path length and chances of photons to be absorbed

System description: absorption and attenuation are to be obtained from a spectrometry-based system (see Fig. 6.5.1). Two cuvettes are used to measure absorption and attenuation respectively. At one end, a light source emits light and at the other end a detector measures the light which passed through the cuvette. All the elements of the system are mounted on a frame. When profiling, the system is autonomous (no connection to the ship for power or data transfer). It encompasses:

- A Wetlabs ac-s which measures absorption and attenuation in the visible with a spectral resolution of 4nm.
- A pump powered by the ac-s assuring a constant water inflow into the two ac-s cuvettes.

- A Seabird SBE37 SIP CTD which measures pressure, salinity and temperature. These two variables are used in the processing of the ac-s data as they both influence water absorption and scattering.
- A datalogger Wetlabs DH4 which powers the ac-s and the CTD via a serial connector. The Datalogger stores both ac-s and CTD data in its internal memory
- A battery pack which powers the DH4.

Preparation:

- From best- to worst-case scenario, the system should be deployed from: (i) the side of the ship with a winch/crane, (ii) a hole in the sea ice with a small winch (if ice station), and the last and less useful option is (iii) the moonpool. **Deployment from the moonpool involves losing the first 10 meters which are by far the most important optically speaking, but also risks contamination of the instrument by any grease/oil in the moonpool which may compromise the instrument and result in corrupt data and lot of work to clean the instrument.**
- **Deployment should preferably take place right before or after the CTD rosette cast in which the CDOM and particle samples are collected!**
- If first deployment of day, make sure the optics have been cleaned since last deployment.
- Check that each component is correctly mounted on the frame and that the screws are correctly tightened (**they must not be overtightened**)
- Check that the two cuvettes are well mounted on the ac-s: the cuvette letters "a" (for absorption channel) and "c" (attenuation channel) should be aligned in the same direction as the "a" and "c" letters of the instrument
- Check that the plumbing is correctly mounted and secured
- Check that all the electrical connectors are correctly plugged and dummy plugs in place.

Deployment:

1. Attach the frame to a (non-conducting) cable on winch deployment of the system.
2. When ready for deployment, turn on the system by pushing the white pin in of the DH4.
3. As soon as the system is turned on, immerse it into water at depth of 20m.
4. Leave the system immersed at 20m depth for 3 minutes. This is important to assure that all the air bubbles (major source of measurement artefacts) are flushed out of the system.
5. Bring back to water depth 1m (the system must stay completely immersed).
6. Depending on available time, do (i) ideally 2 profiles between 1-50m water depth + 1 profile between 1-100m or (ii) if limited time 3 profiles between 1-50m depth. Profile speed 0.3m/s (takes approx. 15-20 minutes). **The instrument must stay in the water between the profiles to prevent air from entering the plumbing.**
7. Bring the frame back to the ship and pulling the white pin out the DH4 for stopping acquisition.
8. Rinse the system with fresh water and in particular its water circuit by connecting a hosepipe on the outside of the pump (the water should flow by the bottom of the two ac-s cuvettes)
9. Disconnect the DH4 power cable from the battery and place back the dummy plug on the battery
10. Write down date, time and station code corresponding to the profile.
11. After the last use of a day, the cuvettes need to be disassembled/reassembled for optics cleaning and drying. This step has to be done by a person previously trained at least once by one of the responsables of the method.

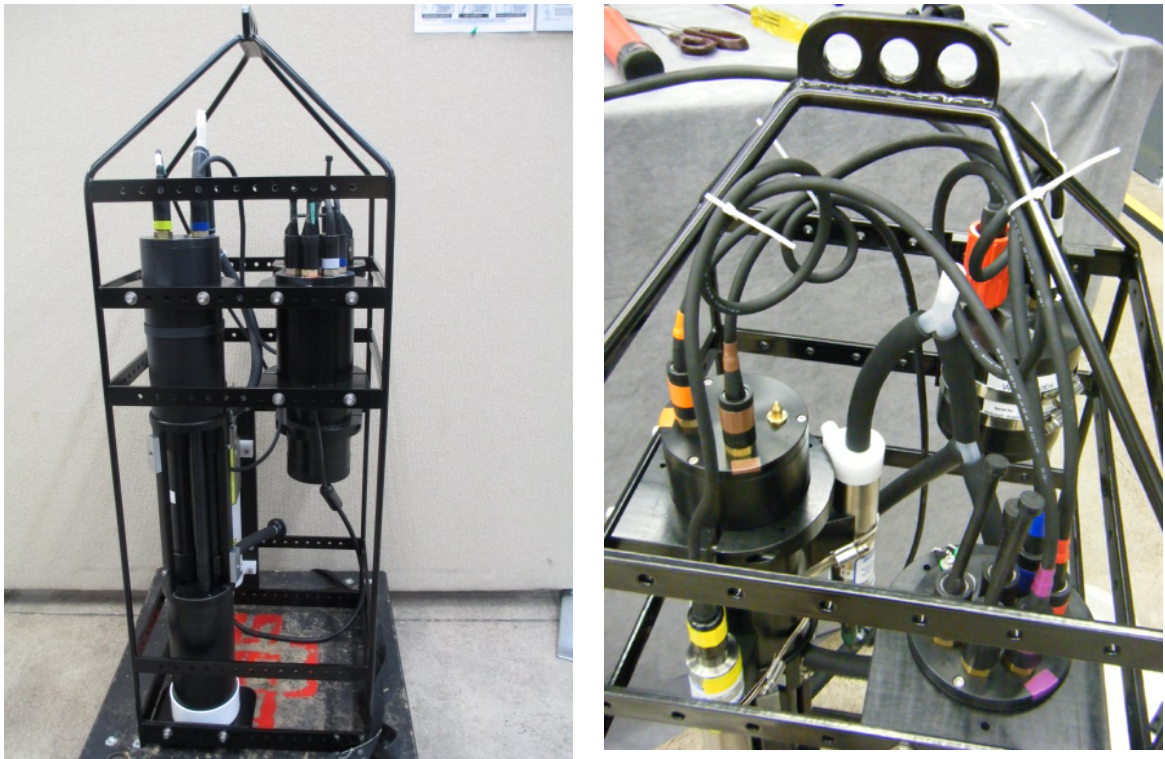

Fig. 6.5.1-1 Ac-s system. Left: Global view of the system with the ac-s on the left and the DH4 on the right of the picture. Right: Zoom on the upper part of the system.

6.5.2 Volume scattering function profile

Measured parameter: Hyperspectral measurements of the following Inherent Optical Properties (IOP) in the visible: Volume Scattering Function (VSF)

Method responsible: Tristan Petit (RF1: NPI, Tristan.petit@npolar.no), Børge Hamre (RF1: UiB, borge.hamre@uib.no)

Description of parameter: The volume scattering function (VSF) represents the statistical angular distribution of the scattering.

System description: The VSF is obtained with a Sequoia LISST-VSF instrument. This instrument includes a laser source and two kinds of detectors: (i) ring detectors measuring very forward scattering ($0-14^\circ$) and (ii) a rotating eyeball detector measuring forward to backward scattering ($15-150^\circ$). The system includes:

- A steel frame
- A battery pack
- The LISST-VSF

Preparation:

- From best- to worst-case scenario, the system should be deployed from: (i) the side of the ship with a crane, (ii) a hole in the sea ice with a winch (if ice station), (iii) the moonpool. **Deployment from the moonpool involves losing the first 10 meters which are by far the most important optically speaking.**
- If first measurement of the day, make sure the battery has been charged after last measurement
- Make sure the optics have been cleaned with optical grade cleaning tissue wet successively with Milli-Q water and ethanol
- Make sure the LISST-VSF and the battery pack are correctly mounted on the frame and the screws tighten correctly.
- Make sure the instrument is correctly connected to the battery

Deployment:

1. Attach the frame to a winch or a crane for a vertical deployment of the system
2. When ready for deployment, turn on the system by turning the switch from 0 to 1 position on the LISST-VSF.
3. As soon as the system is turned on, immerse it into water.
4. Let the system completely immersed (eg. 1-3m depth) during 3 minutes to let the instrument temperature being stabilized.
5. Do 3 profiles between 0-50m water depth. Profile speed 0.3m/s (takes approx. 15-20 minutes). **Deeper profiles are useless since the system stops measuring (technological constraint) from 50m depth.**
6. Bring the system back to the ship and turn the switch on 0 to stop acquisition.
7. Wash the system with fresh water

7 Water samples from Niskin bottles

The order of sampling from the Niskin bottles (see 6.2 Niskin Rosette) should be decided on as some samples need to be taken immediately. Here one should also agree on some general rules when sampling from Niskin bottles, e.g. use of Nitril gloves.

All water samples taken from the ships Niskin bottles should be described in an own sub-chapter.

7.1 SALINITY SAMPLES

For sampling of salinity samples, see chapter 6.2 Niskin Rosette.

Method responsible: Angelika Renner (IMR, angelika.renner@hi.no)
(description of Salinometer will come when instrument is installed on KPH)

7.2 SAMPLING OF DIC, AT AND PH

Sampling of DIC/pH from the Niskin-bottle rosette will take place first (if no other sensitive gases are sampled, such as dissolved oxygen). From the Niskin bottle, use a tubing to gently fill a 250 ml borosilicate bottle (glass bottle with blue plastic cap) to avoid air bubbles, overfill 1-2 volumes for rinsing and removing air bubbles.

7.2.1 Total dissolved inorganic carbon (DIC)

Measured parameter: Total dissolved inorganic carbon (DIC, $\mu\text{mol/kg}$)

Method responsible: Melissa Chierici (IMR, melissa.chierici@hi.no) and Agneta Fransson (NPI, agneta.fransson@npolar.no)

Description of parameter: Total dissolved inorganic carbon measures the sum of bicarbonate, carbonate and carbonic acid and dissolved CO_2 (the sum of carbonic acid and CO_2 is generally referred as H_2CO_3^*) in seawater, melted sea ice and brine, snow. Other abbreviations that are used instead of DIC are TCO_2 and CT.

Method description:

→ Special laboratory requirements:

- Dry-lab with as constant temperature as possible. 3 meters of bench place, with space on top of bench (preferably no cupboards) and room under bench for circulating water baths. Room needs a sink for seawater waste.
- Nitrogen gas (20 L cylinder at 200 bar) to be secured near the instrument to allow control and short distance.
- Refrigerator on short distance or in room, access to MQ water

→ **Sampling depths:** Standard 12 depths, more than 12 depths when deeper than 300m (NOTE: chemical profile needs to be in one cast all depths!)

→ **Chemicals used:** 10% phosphoric acid, cathode and anode solution (DMSO and thymol blue) potassium iodide salt (KI), nitrogen gas (high-quality)

DIC will be sampled and analysed directly onboard KPH and follow the state-of-the-art method described in Dickson et al. (2007). DIC was determined using gas extraction of acidified samples followed by coulometric titration and photometric detection using a Versatile Instrument for the Determination of Titration Alkalinity (VINDTA 3D, Marianda, Germany). Accuracy of the measurements is ensured by routine analyses of Certified Reference Materials (CRM, provided by A. G. Dickson, Scripps Institution of Oceanography, USA). Precision is derived from repeated measurements on a daily basis.

7.2.2 Total alkalinity (AT)

Measured parameter: Total Alkalinity (AT, $\mu\text{mol/kg}$)

Method responsible: Melissa Chierici (IMR, melissa.chierici@hi.no) and Agneta Fransson (NPI, agneta.fransson@npolar.no)

Description of parameter: Total alkalinity (AT) is a measure of the buffer capacity of a seawater towards acidic or basic input. Other commonly used acronyms is TA.

Method description:

→ **Special laboratory requirements:** Dry-lab with as constant temperature as possible. 2 meters of bench place, with space on top of bench (preferably no cupboards) and room under bench for circulating water baths. Room needs a sink for seawater waste.

→ **Sampling depths:** Standard 12 depths, more than 12 depths when deeper than 300m (NOTE: chemical profile needs to be in one cast all depths!)

→ **Chemical used:** Hydrochloric acid (0.1 N), electrolyte solution (saturated potassium chloride, KCl).

Sampling and analyses of AT will take place onboard and be determined by potentiometric titration with 0.05 N hydrochloric acid (HCl) using a Titrande (Metrohm, Swiss) system with a Dosino (Metrohm) to allow for precise volume addition (sample volume 40 ml). The equilibration point is evaluated using a Gran evaluation in addition to end-point detection in the Tiamo software (Metrohm). Accuracy of the measurements is ensured by routine analyses of Certified Reference Materials (CRM, provided by A. G. Dickson, Scripps Institution of Oceanography, USA). Precision is derived from repeated measurements on a daily basis.

A selection of duplicate samples (20-40 samples) will be stored and analysed post-cruise at the IMR laboratory in Tromsø for quality and consistency check using the state-of-the-art instrumentation for potentiometric titration in a closed cell (100 ml) and 0.1 N HCl on a Versatile Instrument for the Determination of Titration Alkalinity (VINDTA 3S, Marianda, Germany).

7.2.3 pH

Measured parameter: pH (total scale, spectrophotometric)

Method responsible: Melissa Chierici (IMR, melissa.chierici@hi.no) and Agneta Fransson (NPI, agneta.fransson@npolar.no)

Description of parameter: pH is a measure of the acidity (hydrogen ion concentration/activity) of a seawater

Method description:

→ **Special laboratory requirements:** Dry-lab with as constant temperature as possible. 2 meters of bench place, with space on top of bench (preferably no cupboards). Room needs a sink for seawater waste.

→ **Sampling depths:** Standard 12 depths, more than 12 depths when deeper than 300m (NOTE: chemical profile needs to be in one cast all depths!)

→ **Chemical used:** m-cresol purple (2 mM solution)

Sampling and analyses of pH will take place onboard and is determined spectrophotometrically (Diode array spectrophotometer, type for ex: HP8453, Cary (former Agilent) using a 2mM solution of the sulfonaphtalein dye m-cresol purple as an indicator (Clayton and Byrne, 1993). Perturbation of indicator pH was corrected using the formulation described in Chierici et al. (1999).

7.3 SAMPLING FOR $\Delta^{18}\text{O}$ (DELTA-O-18)

Measured parameter: $\delta^{18}\text{O}$ (or delta-O-18)

Method responsible: Mats Granskog (RF1, NPI, mats.granskog@npolar.no), Agneta Fransson (RF2, NPI, agneta.fransson@npolar.no)

Description of parameter: $\delta^{18}\text{O}$ (or delta-O-18) is a measure of the ratio of stable isotopes oxygen-18 (^{18}O) and oxygen-16 (^{16}O). It is commonly used with measurement of salinity of seawater to infer the amount of different

freshwater sources in a seawater sample (sea-ice melt water or river/glacial water).

Methodological description:

→ Special requirements/gear:

→ **Sampling depths:** Standard 12 depths, more than 12 depths when deeper than 300m (NOTE: chemical profile needs to be in one cast all depths!)

→ **Chemicals used:**

Materials:

- Plastic (HDPE) bottle (15ml) with plastic caps (VWR number 215-7503, Figure 1).
- Parafilm (50mm × 50mm squares)
- Labels

Method:

Bottle is completely filled with seawater and cap closed tightly. Afterwards the vial must be sealed with Parafilm. Large headspace (of air) will contaminate the sample during storage.

- 1) Fill the bottle with seawater from the Niskin bottle. As full as possible to leave as little air inside bottle as possible.
- 2) Close the cap without touching the inside. Turn bottle upside down, if there is a little bubble of air it is ok.
- 3) Dry the outside of the cap and the bottle. Tighten the cap.
- 4) Seal the bottle cap with Parafilm. The Parafilm must be stretched **tightly** around the cap. If it is loose it will fall off. Practice applying Parafilm to an empty vial until you can do it securely. It helps to warm the parafilm for 5 seconds between the palms of your hands to make it stretch better without breaking.
- 5) Label sample (preferable before sampling, to make sure label attaches well).

→ **Sample storage / Shipment address** Store the $\delta^{18}\text{O}$ samples at +4°C in dark (in refrigerator onboard). Room temperature storage is fine if bottles are well sealed. DO NOT FREEZE!

Shipment: Norsk Polarinstitut
Framsenteret
Hjalmar Johansens gate 14
9007 Tromsø
ATT: Mats Granskog/Agneta Fransson



Fig. 7.3-1 Bottle and cap

7.4 PARTICULATE ORGANIC CARBON (POC) AND NITROGEN (PON)

Measured parameter: Quantification of particulate organic carbon and nitrogen (in $\mu\text{g C}$ or N L^{-1}).

Method responsible: Marit Reigstad (UiT, marit.reigstad@uit.no), Gunnar Bratbak (UiB, gunnar.bratbak@uib.no), Miriam Marquardt (UiT, miriam.marquardt@uit.no)

Description of parameter:

Methodological description:

→ **Special requirements/gear:** Drying oven, pre-combusted GF/F filters, NB: no woolen cloth!

→ **Sampling depths:** All standard depths

→ **Chemicals used:** none

Method:

- Collect seawater from the Niskin bottles from standard depths. Rinse the plastic sampling bottle with sample water (~100 ml) before collecting the sample.
- Remember to gently mix the bottle (turn upside down for a couple of times) before filtering to ensure that no particles settle down (results in uneven concentration if subsampling the sampling bottle).
- Be sure to have placed the filter in the middle of the filter holder and that the funnel is thoroughly placed on top of it (if something is leaking the exact volume filtered or the filtration area on the filter is not known – these are needed for the calculations later).
- Filter 3 replicates with ca. 50-2000 ml (depending on biomass – a light colour on the filter is enough) from each depth through pre-combusted 25 mm GF/F filters.
- Use low vacuum pressure (about -30 kPa). Always have the valve of the filtering funnel closed before turning the pump on or off.
- Cover the funnels with tin foil when filtering. If you expect to filter 1 L or 2 L, you can place the respective plastic bottle into the funnel and let it run. Ideally the 0.5 and 1 L mark should be indicated on the plastic sampling bottles.
- Rinse the funnel with filtered seawater (collect filtered sea water from previous filtrations) once the sample has been filtered. Do not let the filters dry out, close the valve.
- After filtration, each GF/F filter should be directly 1 time folded and placed in tin foil labelled with Nansen Legacy stickers. Collect all the tin foil replicates from one station and keep them in a labelled Ziploc bag at -20 degr C.
- Rinse the filtration equipment with MilliQ before the next sample. Cover filtration funnel with tin foil when not in use (to avoid dust).
- For each sampling day or event, prepare a blank filter by filtering MilliQ water through a pre-combusted GF/F filter (similar volume than sea water for the samples) and treating it the same way than the samples. The blank filters get normal sample running number (but make an additional note “MilliQ” on the sample label/analysis slide), and are noted in the filtering protocol and log sheet. Make also a note on CTD log sheet to avoid confusion with numbering on following casts.

→ **Samples storage/shipment address:** POC/N samples should be wrapped in tin foil and stored at -20 C until further processing at UiT and UiB.

7.5 TOTAL (TOC) AND ORGANIC CARBON

Measured parameter: Quantification of total organic carbon (TOC) (mg C L^{-1}).

Method responsible: Murat Van Ardelan (NTNU, murat.v.ardelan@ntnu.no)

Description of parameter: total organic carbon quantification using high temperature combustion (680°C) instrument (TOC-L, Shimadzu)

Methodological description:

→ **Special requirements:** Rosette sampler with Niskin bottles

→ **Sampling depths:** 6 depths (Stations P1-P5: 5m, 10m, 20m, Deep Chlorophyll Maximum (DCM), 60m and near bottom; Stations P6-P7: 5m, 10m, 20, DCM, 120m, near bottom). To be collected from the Rosette.

→ **Chemicals used:** HCl (30%, puriss p.a, ACS reagent), HCl (30%, reagent grade) and acid detergent (Citranox®)

Laboratory Instrumentation:

- TOC-L Instrument, Shimadzu
- Combustion oven (450°C)

→ **NOTE:** Use Borosilicate Type 1 glass for carbon analysis

→ **NOTE:** Do not use TYGON® tubing for carbon analysis

→ **NOTE:** Grease should never be used

Materials:

- Silicon Tubing: To collect from Rosette
- Aluminum foil: for protecting water during filtration
- 40ml type 1 borosilicate glass vials with septum caps

Cleaning of glassware (Type 1 borosilicate): (gloves, safety glasses, and lab coat were used at all times)

1. Remove paper, plastic, or marker labels from all glassware
2. Immerse glassware in an acid detergent bath (1%) for at least 8 hours
3. Rinse the vials three times with distilled water
4. Dry the glass in a drier until completely dry, usually around 2 hours at 80°C
5. Wrap the vials with aluminum foil in packages small enough to be placed inside a combustion oven
6. Combust the glassware in an oven at 450°C for 4 hours

Plastic caps for vials were cleaned separately with the following procedure:

1. Place the caps in a 1% HCL (reagent grade) bath for 2 hours
2. Rinse after the HCL bath with MiliQ water
3. Place the caps to dry in a drier at 60°C for 2 hours or until completely dry
4. Transfer the caps to a clean glass container and keep them sealed until needed

Method:

After collection of seawater, 3 replicates of 40 ml TOC samples acidify with HCl (30% ultrapure, 250 µl to 40 ml) in glass (combusted) vial preserved in refrigerator (4°C)

→ **Samples storage/shipment address:** the samples should be stored in dark at 4°C until laboratory analysis

7.6 DISSOLVED ORGANIC MATTER CHARACTERIZATION (DOM/C)

Measured parameter: Dissolved organic matter (DOM), Dissolved organic carbon (DOC) quantification and Total dissolved nitrogen (TDN)

Method responsible: Murat Van Ardelan (NTNU, murat.v.ardelan@ntnu.no)

Description of parameter: Qualitative analysis of the major components and distribution of dissolved organic matter at discrete depths.

Methodological description:

→ **Special requirements/gear:** Niskin rosette

→ **Sampling depths:** 6 depths (Stations P1-P5: 5m, 10m, 20m, Deep Chlorophyll Maximum (DCM), 60m and near bottom; Stations P6-P7: 5m, 10m, 20, DCM, 120m, near bottom). To be collected from the Rosette.

→ **Chemicals used:** Methanol (washing and HPLC grade), Hydrochloric Acid (32 %)

Materials:

- Deep freeze space (ca 40x60x30 cm)
- Refrigeration space (ca 50x50x50 cm)
- Bench space 1.5 m² with sink necessary for filtration and extraction
- Silicon Tubing: To collect from Rosette
- pH meter: for seawater pH change
- Styrofoam Box for freezer storage (59x30x39cm)
- 15ml Type 1 borosilicate glass amber vials

Laboratory Instrumentation:

- HPLC ESI Mass Spectrometer, Synapt G2S
- Combustion oven (450°C)

→ **NOTE: Use Borosilicate Type 1 glass for carbon analysis**

→ **NOTE: Do not use TYGON® tubing for carbon analysis**

→ **NOTE: Grease should never be used**

Filtration system:

- Vacuum pump: To filter seawater
- Glass funnels (500-1000ml) (3)
- Base Support fritted (Ø47mm) with side valve (3)
- GF/F glass microfiber filters, Ø47mm, (0,7µm nominal pore size)
- Clamps (3): To hold the flask the filter and the funnel
- 10L glass borosilicate glass bottles with GL45 neck (9)
- Silicon tubing: To connect vacuum pump to filtration set up
- Connectors for multi tubing connection to vacuum pump
- Aluminum foil: for protecting water during filtration

Reagents:

- 0,01M HCl Ultrapure
- HCl (30%, puriss p.a, ACS reagent)
- Methanol >99,9% HPLC grade
- Water, HPLC grade

Solid Phase Extraction (SPE) system:

- Peristaltic pump
- Peristaltic tubing white purple (internal diameter 2.79 mm)
- Glass pipettes (10 ml): To place inside the glass bottles (10L) and connect to the tubing and the SPE cartridges. Six to conduct simultaneous filtration of depths.
- Silicon Tubing
- SPE vacuum manifold: To Perform SPE elutions
- Scintillation amber vials (15ml): type 1 glass for extraction
- Waste vials for SPE extraction

Cleaning of glassware (Type 1 borosilicate): (gloves, safety glasses, and lab coat were used at all times)

1. Remove paper, plastic, or marker labels from all glassware
2. Immerse glassware in an acid detergent bath (1%) for at least 8 hours
3. Rinse the vials three times with distilled water
4. Dry the glass in a drier until completely dry, usually around 2 hours at 80°C
5. Wrap the vials with aluminum foil in packages small enough to be placed inside
a
combustion oven
6. Combust the glassware in an oven at 450°C for 4 hours

Plastic like caps for vials were cleaned separately with the following procedure:

1. Place the caps in a 1% HCL bath for 2 hours
2. Rinse after the HCL bath with MiliQ water
3. Place the caps to dry in a drier at 60°C for 2 hours or until completely dry
4. Transfer the caps to a clean glass container and keep them sealed until needed

Method:

- After collection of seawater, 3 replicates of 40 ml TOC samples acidify with HCl (30% ultrapure, 250 µl to 40 ml) in glass (combusted) vial preserved in refrigerator (4°C) ([see 7.5 TOC protocol](#) for details).
- Use one GF/F filter (pre-combusted) per max 10L seawater and condition with seawater prior to use (max flow 40ml/min)
- Acidify the filtrated seawater with UP HCL (30%) bring pH to 2.0, check with pH meter if needed.
- collect DOC quantification samples (triplicates in 40ml glass vials- see section 7.6.1). Rinse three times prior to filling and leave headspace for expansion.
- The samples in the vials should be kept in refrigerator and dark
- Condition SPE cartridge: Add waste vials inside SPE vacuum manifold sample rack
- Set new disposable plastic liner (USE NEW per sample)
- Rinse SPE cartridge with Methanol (HPLC grade) using 2X SPE cartridge volume
- DO NOT LET SPE SORBENT DRY OUT before sample loading
- Remove SPE cartridge from manifold and connect to filtered seawater. max 40ml/min flow. (peristaltic pump at 10rpm or 3.9%)
- Disconnect SPE cartridge and set back to vacuum manifold
- Add 0,01M UP HCl (2X SPE cartridge volume) to SPE sorbent using glass volumetric pipette
- Purge SPE sorbent with air or Nitrogen for 5mins (or turn on vacuum pump at -20psi 10mins)
- Final DOM elution: FIRST REPLACE waste VIAL to FINAL VIAL in manifold and add HPLC grade methanol to final vials (<6ml/min flow). Methanol volume depends on initial DOC concentration of Seawater and desired final concentration.
- Store samples at -20C

Method Blank Sampling

- Using the same setup as samples, run 3 deionized water blanks of 0.5-1L each.
- Collect a water (HPLC grade) sample for TOC analysis. (See Protocol 7.5)
- Filter water (HPLC grade) same as DOM characterization
- Acidify to pH=2 using UP HCl
- collect blank sample in 40ml glass vials with septum.
- Then follow same steps for DOM extraction using SPE cartridges.
- Store blanks at -20°C

Ancillary measurements:

- TOC: 3 replicates in 40 ml glass vials filled with headspace and acidified to pH=2 (See protocol [7.5](#)).

7.6.1 DOC/TDN-quantification

Measured parameter: Quantification of carbon in Dissolved organic carbon (DOC) and Total dissolved nitrogen (TDN)

Method responsible: Murat Van Ardelan (NTNU, murat.v.ardelan@ntnu.no)

Description of parameter: dissolved Carbon and Nitrogen quantification using high temperature combustion (680°C) instrument (TOC-L, Shimadzu)

Methodological description:

→ **Special requirements:** Rosette sampler with Niskin bottles, Bench space 1.5 m² with sink necessary for filtration

→ **Sampling depths:** SAME AS DOM CHARACTERIZATION DEPTHS. 6 depths ([Stations P1-P5](#): 5m, 10m, 20m, Deep Chlorophyll Maximum (DCM), 60m and near bottom; [Stations P6-P7](#): 5m, 10m, 20, DCM, 120m, near bottom). To be collected from the Rosette.

→ **Chemicals used:** HCl (30%, puriss p.a, ACS reagent), HCl (30%, reagent grade) and acid detergent (Citranox[®])

Laboratory Instrumentation:

- TOC-L Instrument, Shimadzu
- Combustion oven (450°C)

→ **NOTE:** Use Borosilicate Type 1 glass for carbon analysis

→ **NOTE:** Do not use TYGON[®] tubing for carbon analysis

→ **NOTE: Grease should never be used**

Materials:

- Silicon Tubing: To collect from Rosette
- Vacuum pump: to filter seawater
- Glass funnels (500-1000ml) (3)
- Base Support fritted (47mm) with side valve (3)
- GF/F glass microfiber filters, \varnothing 47mm, (0,7 μ m nominal pore size)
- Clamps (3): To hold the flask the filter and the funnel
- 10L glass borosilicate glass bottles with GL45 neck (9)
- Silicon Tubing: To connect vacuum pump to filtration set up
- Connectors for multi tubing connection to vacuum pump
- Aluminum foil: for protecting water during filtration
- 40ml type 1 borosilicate glass vials with septum caps

Cleaning of glassware (Type 1 borosilicate): (gloves, safety glasses, and lab coat were used at all times)

1. Remove paper, plastic, or marker labels from all glassware
2. Immerse glassware in an acid detergent bath (1%) for at least 8 hours
3. Rinse the vials three times with distilled water
4. Dry the glass in a drier until completely dry, usually around 2 hours at 80°C
5. Wrap the vials with aluminum foil in packages small enough to be placed inside
 - a
 1. combustion oven
6. Combust the glassware in an oven at 450°C for 4 hours

Plastic caps for vials were cleaned separately with the following procedure:

1. Place the caps in a 1% HCL (reagent grade) bath for 2 hours
2. Rinse after the HCL bath with MiliQ water
3. Place the caps to dry in a drier at 60°C for 2 hours or until completely dry
4. Transfer the caps to a clean glass container and keep them sealed until needed

Method:

- After collection of seawater, 3 replicates of 40 ml TOC samples will be
- acidified with HCl (30% ultrapure, 250 µl to 40 ml) in glass (combusted) vial preserved in
- refrigerator (see 7.5 TOC protocol for the details).
- Use one GF/F filter (0,45µM pre-combusted) per max 10L seawater and condition with seawater prior to use (max flow 40ml/min)
- Acidify the filtrated seawater with UP HCL (30%) bring pH to 2.0, check with pH meter.
- collect DOC quantification samples per depth (triplicates in 40ml glass vials). Rinse three times prior to filling and leave headspace for expansion.
- The samples in the vials should be kept in refrigerator and dark until
- analysis

Ancillary measurements:

- Total dissolved Nitrogen (TDN) is measured simultaneously from same vial (need ca. 10ml for TDN analysis) using same TOC-L catalytic combustion instrument

7.7 TRACE ELEMENTS SAMPLING VIA GO FLO BOTTLES

Measured parameter: Trace elements (in nmol or µmol L⁻¹).

Method responsible: Murat Van Ardelan (NTNU, murat.v.ardelan@ntnu.no)

Description of parameter: Quantification of particulate, total acid leachable and dissolved metal/ element concentration (in nmol L⁻¹).

Methodological description:

→ Special requirements/gear:

- GO -Flo bottles (Teflon coated)
- Ste line or Kevlar winch line (polymer-non-metallic line)

- Class 100-clean air laminar flow bench (place for this and additional lab space for clean sample treatment (this space will be decked by PE sheet, and it should be in the area where there is minimal human activity (minimum turbulence)
- Lab space: minimum 4-5 m² lab space including bench and sink is needed (this space will be decked by PE sheet temporarily to create a “clean -lab / dust free environment

→ **Sampling depth(s):** Subject to change depending on context, physical and biological in situ measurements temporary depths, 10, 20, 40, 60, 120, 300, 500 and ca 10 m above sediment-water interface

→ **Chemicals used:**

NOTE: 1-GO-FLO deployment with polymer line (either ste-line or kevlar) sampling is necessary for clean trace metal sampling

Method:

- Steps after GO FLO cast completed
- GO FLO bottles will immediately be placed in the clean lab space into the GO FLO racks. Work will be performed under Class -100 laminar flow chamber
- Total acid leachable trace elements (TTE): replicates of 125 ml TTE sample (without filtration) will be collected and acidify to ca pH 1.7
- Dissolved trace elements (DTE): Ca 200 ml of seawater will be filtrated with Sartobran Sartorius double-layer (0.4-0.2 µm pore size) and acidified to ca pH 1.7
- TTE and DTE samples can be stored under room temperature in double PE bags, and send
- to NTNU for final SeaFAST preconcentration and HP-ICP-MS analysis

7.7.1 Mercury sampling via GO FLO bottles

Measured parameter: Inorganic mercury and methylmercury

Method responsible: Stephen G. Kohler (NTNU, stephen.g.kohler@ntnu.no), Murat V. Ardelan (NTNU, murat.v.ardelan@ntnu.no)

Description of parameter: Quantification of total mercury (THg) and total methylated mercury (MeHg) in pmol L^{-1}

Methodological Description:

→ Special requirements/gear:

- GO-FLO bottles (Teflon coated)
- STE line or Kevlar winch line (polymer non-metallic line)
- Class 100 - clean air laminar flow hood
- Clean lab space: minimum 5m^2 including bench and sink, covered with polyethylene plastic to form clean lab "bubble"
- Clean air filter for clean lab space

→ Sampling depths:

- Subject to change depending on physical and biological characteristics
- Generally, 8 depths with Kevlar line: 10m, 20m, 40m, 60m, 90m, 120m, 250m, 500m, and bottom-10m
- Deeper depths taken from CTD Niskin bottles due to Kevlar line maximum of 500m

→ Chemicals used: Double-distilled hydrochloric acid (HCl)

Method:

- GO FLOs immediately transported back to clean lab plastic bubble space with clean air filter and placed into GO FLO racks
- HEPA filter attached to top valve of GO FLO to prevent airborne particulates entering bottle
- Sample bottles for THg, 40mL precleaned borosilicate amber glass bottles with polypropylene cap with PTFE septum, rinsed 3 times with unfiltered seawater from each depth
- Sample bottle for THg filled up leaving zero headspace and capped, unpreserved
- Sample bottles for MeHg, 125mL brand new PET plastic bottles, rinsed 3 times with unfiltered seawater from each depth

- Sample bottle for MeHg filled up leaving zero headspace and capped
- MeHg samples preserved with double-distilled HCl to below pH 2, for 0.4% (v/v) HCl inside Class 100 clean air laminar flow hood
 - Note: Dimethylmercury is converted to monomethylmercury upon acidification, thus the sample represents total methylated mercury, the sum of monomethyl- and dimethylmercury
- Bottles are stored in the dark in double plastic bags at approximately 4°C before analysis

THg bottle cleaning description:

- Description roughly follows cleaning protocol recommended by "Sampling and Sample Handling for GEOTRACES Cruises, Volume 3, Chapter 8: *Protocols for Sampling and Determinations of Mercury and Its Speciation*"
- Bottles and caps are submerged in 1% (v/v) Citranox acid detergent for six (6) days
- Bottles and caps rinsed 3-5x with MilliQ water
- Bottles filled and capped with 1.2M HCl (analytical grade) for at least six (6) days
- Bottles and caps rinsed 5x with MilliQ water
- Bottles filled and capped with 0.5% (v/v) BrCl solution for 24 hours
- Bottles and caps rinsed 3x with 0.01M HCl (double distilled)
- Bottles and caps rinsed 5x with MilliQ water
- Bottles capped and stored in double-plastic bags for use

7.8 SAMPLING AND DETERMINATION OF CDOM ABSORPTION

7.8.1 Sampling for CDOM

Measured parameters: Colored Dissolved Organic Matter (CDOM)

Method responsible: Mats Granskog (RF1: NPI, mats.granskoog@npolar.no), Børge Hamre (RF1: UiB, borge.hamre@uib.no), Murat V. Ardelan (RF2: NTNU, murat.v.ardelan@ntnu.no)

Description of parameter: CDOM is here defined as material passing through a nominal 0.22 µm pore size membrane filter.

Methodological description: CDOM is obtained by keeping the filtrate of a sea water sample passing through a Millipore Opticap XL4 0.22 μ m filter.

→ **Sampling depths:** Standard depths 5, 10, 20, 50, 100m, Chl-a max. Whenever possible, collect from same Niskin and same depths as DOC, Chl-a, TSM, particle absorption and $\delta^{18}O$.

Materials:

- Amber EPA type glass vials with caps (20-40ml, burned and caps acid-washed)
- Filter capsule (Millipore Opticap XL4, Durapore 0.22 μ m, KVGLA04HH3) and (clean) tubing
- Laboratory gloves
- Labels

Preparations:

- *Before a new filter cartridge is used the first time, it has to be rinsed with 4 L of Milli-Q water or clean seawater* (from great depth with little particles or DOM) with gravity to clean off any residuals on the membrane. Tubing used should also be acid soaked in weak acid and copiously rinsed before use.
- The same filter cartridge can (normally) be used for hundreds of samples. *Always start with the deepest seawater sample* (as it normally is the “cleanest” one) and move towards the surface when collecting sample water from the rosette. It is always good to flush with extra seawater through the capsule before collecting the first sample at each station.
- *Always use laboratory gloves* when collecting the samples to minimize the contamination risk, as any fats, oils etc. on your hands contaminates further measurements. Do not to touch the insides of the vials and caps, or the tip of the nozzle on the Niskin bottle or the filter capsule inlet/outlet, as these parts come in contact with sample water. Avoid touching anything that is dirty, dirty gloves do not help! If you have dirty gloves they do not do their job. Switch to a new pair.

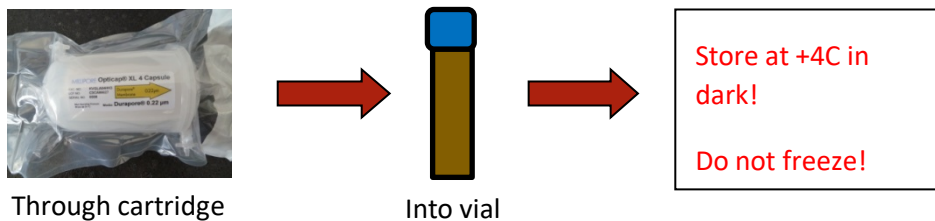

Fig. 7.8.1-1 DOM sampling method

Method (graphical overview on Fig. 7.8.1-1):

1. Attach the tubing to the Niskin nozzle. Check that the capsule is correctly aligned, see Fig. 7.8.1-2
2. Make sure the bottom valve is closed, and the top valve is open. Point the cartridge such that arrow points downwards to help water flow in and through the filter.
3. Open the Niskin nozzle and fill the capsule with seawater (i.e. until water runs out of the open top valve).
4. Close the top valve and let about 200 ml seawater pass through by gravity.
5. Fill the CDOM amber vial to the shoulder. Leave some headspace in vial! Close cap firmly.
6. Close the Niskin nozzle. Remove tubing from Niskin. To empty the capsule before next sample, open the bottom valve, turn the filter upside down (arrow pointing upwards), and let water drain out. Close the bottom valve.
7. Note down the sample ID in the CTD sheet after each sample has been collected to be sure of which Niskin bottle it was collected from!
8. Go to next Niskin bottle. Repeat steps 1 to 7 until you have collected all samples.
9. After station, empty the filter cartridge of seawater (step 5), and rinse with 200-300 ml of Milli-Q water.

10. Store filter capsule and the tubing in a plastic bag or container with Milli-Q between stations, to avoid it getting contaminated.

→ **Sample storage / Shipment address:** Store the CDOM samples in dark at +4°C (in refrigerator onboard). DO NOT FREEZE! Plan is to measure samples onboard, if that is not possible, the samples are to be shipped (in a well-insulated box) to Tristan Petit, IFT, UiB, Bergen

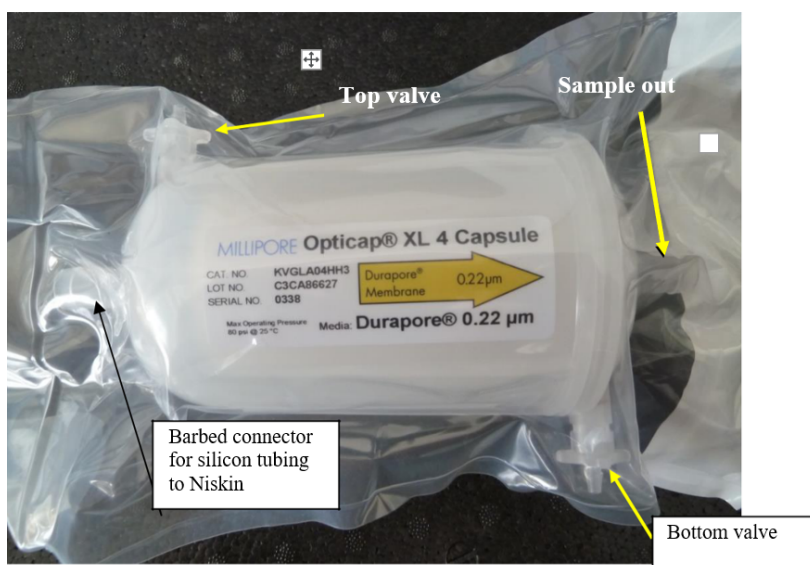

Fig. 7.8.1-2 Filter cartridge in protective bag (exact shape depends on batch and year). An arrow shows the direction water should flow through the filter

7.8.2 Measurement of CDOM absorbance

Measured parameter: Coloured (or chromophoric) dissolved organic matter (CDOM) light absorption in UV and visible (300-750 nm)

Method responsible: Murat V. Ardelan (RF2: NTNU, murat.v.ardelan@ntnu.no), Tristan Petit (RF1 : NPI, tristan.petit@npolar.no)

Description of parameter: CDOM is used for characterization of marine dissolved organic matter (DOM). Absorption is important for the optics of water masses (RF1).

Methodological description: Measurement with Liquid Waveguide Capillary Cells (LWCC) for ultraviolet (UV) and visible (VIS) absorbance spectroscopy is done for ultra sensitive measurements of absorbance. Hence, several factors may affect the data analysis and external interferences must be kept at minimal.

→ **Sampling depth:** All CDOM samples collected (see section 7.8.1) should be measured.

→ **Chemicals used:** Methanol (HPLC grade), 1N HCl (HPLC grade), high grade NaCl solution

Materials:

- Chemicals: Methanol (HPLC grade), 1N HCl (HPLC grade), high grade NaCl solution
- Milli-Q water
- 100mL NaCl solution (from HPLC grade NaCl) of 100g/L NaCl
- Ocean Optics Liquid Waveguide Capillary Cells (LWCC) absorbance spectrometer system (see Fig. 7.8.2-1) with Oceanview software installed and licenced on PC (see Fig. 7.8.2-2)
- Waterbath (*Room temperature*)
- Peristaltic pump

Preparations:

- Fix the LWCC system stably on to workbench and try to minimize movements.
- Switch on the light source of LWCC at least one hour before the start of the measurement for achieving stable temperature and measurements.
- A water bath maintained at constant temperature must be used to stabilize the temperature of reference UPW and NaCl solution before running through LWCC system.

- A constant flow rate of 1 mL/min is maintained during the absorbance measurement. Always remember to fill in the capillary tube completely with the solution before each measurement.
- Connect the spectrometer to the PC with Oceanview software for observing the readings online. The software can be set in absorbance mode. This mode asks for 3 distinct measurements for obtaining one absorbance spectrum: (1) a reference spectrum which is always purified (Milli-Q) water, (2) a dark spectrum obtained shutter closed which is used to cancel out dark current noise and (3) a sample spectrum.

Measurement of absorbance:

1. Measure intensity with reference Milli-Q water. Adjust integration time to avoid saturations. It must reach 70% intensity to account for the fact that transmission will be higher with NaCl solution (higher refractive index). Repeat replicates until stable results are obtained.
2. Measure the apparent absorbance of the different NaCl solutions before first and after last measurements of a day. This requires to alternatively measure the intensity with reference Milli-Q solution and with sample NaCl solution. For each solution, do at least 3 reinjections and for each injection acquire 15-20 spectra.
3. Measure the apparent absorbance of each CDOM sample by alternatively measuring intensity with reference Milli-Q water and sea water sample. For each sea water sample, do at least 3 reinjections and for each injection acquire 15-20 spectra.
4. After each analysis wash the system three times with 10ml UPW. After each sample wash with HCl (10 ml) and methanol (10 ml) followed by at least five times 10 ml UPW rinsing or until the spectra is stable.

Computation of CDOM absorption:

1. Convert each measured apparent absorbance to corresponding apparent Nappierian absorption using the following formula: $a = \frac{(2.303 \cdot A)}{L}$; with the absorption (in m^{-1}), A the absorbance (in AU) and L the optical length (in m)

2. Divide the NaCl apparent absorptions by 91 (empirical number from personal discussion with Dr Rüdiger Rottgers) for obtaining a psu specific correction factor.
3. Correct each apparent CDOM absorption for error due to difference in refractive index between sea water and Milli-Q water by subtracting to it the psu specific correction factor multiplied by current salinity.

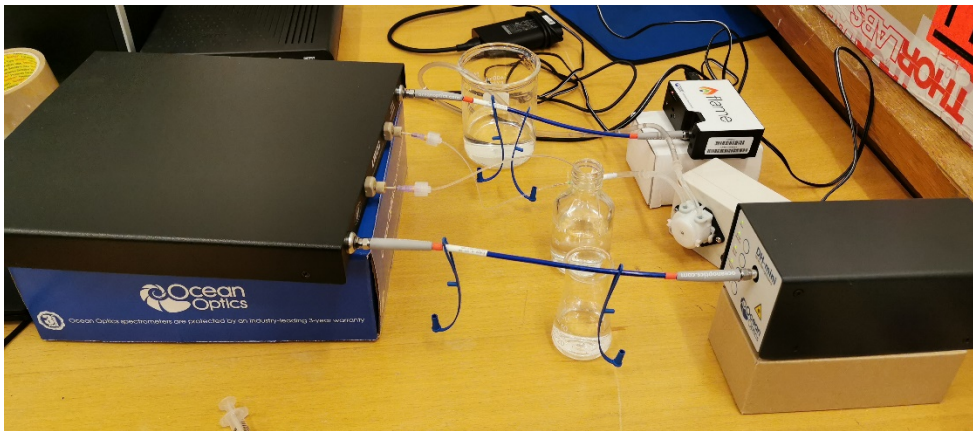

Fig. 7.8.2-1 LWCC system

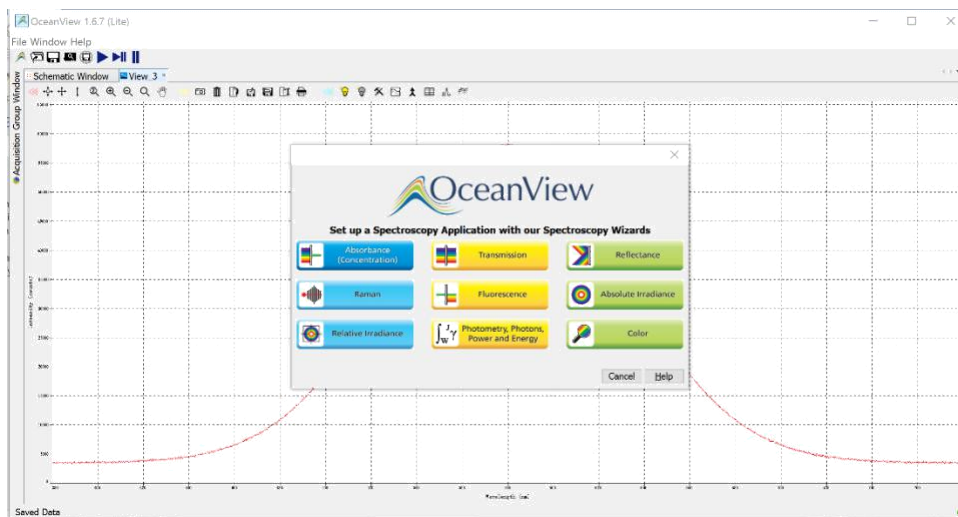

Fig. 7.8.2-2 Oceanview software

7.9 COLLECTION OF PARTICLE CONCENTRATION SAMPLES

Measured parameters: Total suspended matter (TSM), Particulate Inorganic Content (PIM) and Particulate Organic Content (POM) concentrations

Method responsible: Tristan Petit (NPI, tristan.petit@npolar.no)

Description of parameter/principle: Gravimetric determination of TSM concentration, and further separation into PIM and POM by filter combustion

Methodological description:

→ **Sampling depths:** 5, 10, 20, 50m

Replicates: It is important to collect and perform one triplicate per station

Sea water collection:

1. Rinse each of the sampling bottles three times with 50-100ml of sampling water
2. Collect 0.5-3L of seawater (volume depends on expected water turbidity) per sampling depth from the Niskin bottles. Ideally, the Niskin bottle content should have been homogenised beforehand (eg. by placing all its content into a big tank, swirling it and subsampling from it).
3. Store the bottles at room temperature (no need for darkness) before filtration. Filtration should be performed the same day.

Sea water filtration:

1. Homogenise the water to be filtered by gently turning the corresponding bottle upside down several times
2. Measure the desired filtration volume in a measuring cylinder, ideally equipped with a nylon 150-200µm prefilter on top of it. If doubt on the requested volume, start by filtering 1L and add 0.5L by 0.5L until a coloration is visible on the filter.

3. Place an identified pre-combusted and pre-weighted Whatman GF/F 47mm in the centre of the filter holder. It is crucial to write down the correspondence between filter number (present on the petri dish) and station and depth of the water sample.
4. Place the funnel on top of the filter and fill it with sampling water
5. Filter with pump pressure of maximum 0.2 bar, checking for absence of leaks. Leaks should be absolutely avoided as knowledge of the exact filtered volume is critical
6. Add water sample to the funnel, taking care of not emptying the funnel completely before end of filtration
7. Once the desired filtration volume is reached and measuring cylinder empty, rinse the measuring cylinder with Milli-Q water to collect residual particles and add this rinsing water to the filtration funnel.
8. Once filtration funnel is empty, turn off the pump/vacuum
9. Rinse the inner side of the filtration funnel with Milli-Q water and turn on the pump/vacuum again to filter this water.
10. While maintaining pump suction, remove the funnel on top of the filter and rinse carefully with Milli-Q water the filter, including its outer ring, to remove salts (whose presence would otherwise bias the weighting).
11. Stop pump suction and bring back to room pressure
12. If no prefilter was used in step 2., remove any large organism visible by naked eye from the filter
13. Place back the filter in its labelled petri dish and store in the refrigerator.
14. For each filter, keep written log of correspondence between (i) filter number (on petri dish), (ii) volume filtered and (iii) sampling station and depth.

7.10 COLLECTION OF PARTICLE ABSORPTION SAMPLES

Measured parameters: spectral absorption in the visible of total, detrital, and photosynthetically active particles

Method responsible: Tristan Petit (NPI, tristan.petit@npolar.no)

Description of parameter/principle: Spectrometric measurement of filter pad absorption in laboratory, with 25mm GF/F filters placed inside an integrating sphere for cancelling out scattering effects. Measurement performed twice: before/after bleaching to separate detrital and photosynthetically active particles.

Methodological description:

→ **Sampling depths:** 5, 10, 20, 50m

Replicates: It is important to perform one triplicate per station

Blank: It is important for the spectrometric protocol to perform one “blank” filtering per station. This can be obtained by filtering Milli-Q water on a filter with same volume as the one used for sea water samples.

Sea water collection:

1. Rinse each of the sampling bottles three times with 50-100ml of sampling water
2. Collect 0.25-1L of seawater (volume depends on expected water turbidity) per sampling depth from the Niskin bottles into amber glass bottles. Ideally, the Niskin bottle content should have been homogenised beforehand (eg. by placing all its content into a big tank, swirling it and subsampling from it).
3. Store the bottles in cold and dark before filtration. Filtration should be performed in the hours following sampling (the sooner the better)

Sea water filtration:

Prerequisite: Have enough 0.22µm filtered sea water placed in a washing bottle for rinsing (steps 7., 9. and 10). This can be obtained beforehand via the

Millipore Durapore 0.22um filter cartridges used in the "[Sampling for CDOM](#)" protocol of the Nansen Legacy protocol document.

1. Homogenise the water to be filtered by gently turning the corresponding bottle upside down several times
2. Measure the desired filtration volume in a measuring cylinder, ideally equipped with a nylon 150-200um prefilter on top of it. If doubt on the requested volume, **start by filtering 0.1L and add 0.1L by 0.1L** if needed until a **slight greenish coloration** is visually perceptible on the filter. The further spectrometric analysis lies on low optical density of the filter, so it is critical not to filter to much water
3. Place a GF/F 25mm filter in the centre of the filter holder.
4. Place the funnel on top of the filter and fill it with sampling water
5. Filter with pump pressure below 0.2 bar (to minimize cell breakage), checking for absence of leaks. Leaks should be avoided as knowledge of the filtered volume is important
6. Add water sample to the funnel, taking care of never emptying it completely before end of filtration
7. Once the desired filtration volume is reached and measuring cylinder empty, rinse the measuring cylinder with 0.2um prefiltered sea water (not necessary from the same station and depth) to collect residual particles and add this rinsing water to the filtration funnel. **Rincing with Milli-Q water should be avoided to prevent cell breakage because of osmotic pressure.**
8. Turn off vacuum suction as the final volume of water goes through the filter to prevent cell breakage by air suction.
9. If no prefilter was used in step 2., remove any large organism visible by naked eye from the filter
10. Label a plastic capsule (see picture below for the kind a capsule to use) to further identify the filter
11. Place the filter in its labelled plastic capsule for immediate flash freeze in liquid Nitrogen. Flash freezing is crucial to avoid pigment deterioration.
12. Once flash frozen, cover the capsule with aluminium foil and place it in a -80C freezer.

13. For each filter, keep written log of correspondence between (i) filter identification on the capsule, (ii) volume filtered and (iii) sampling station and depth.



Fig. 7.10-1 Plastic capsule to be used for flash freezing of 25mm particle absorption filters

7.11 PARTICULATE ELEMENT CONCENTRATION USING XRF

Measured parameter: Concentration of total particulate O, P, Na, Mg, Si, S, Ca, Mn, Fe, Zn (μM) measured using X-Ray Fluorescence (XRF)

Method responsible: Jorun K. Egge (UiB, jorun.egge@uib.no), Tatiana Tsagaraki (UiB, tatiana.tsagaraki@uib.no)

Description of parameter:

Methodological description:

→ **Special requirements/gear:**

→ **Sampling depths:** Standard depths, all stations 10, 20, 50, 60, 100 and 200m, DCM and deep sample (bottom -15m); **Sampling Volume:** For surface water 500ml should be sufficient. Below Chl max, increase volume to 1000ml if possible.

→ **Chemicals used:**

Before filtration:

- 1) Collect water sample from rosette into a plastic container. The container should be clean and rinsed with distilled water before use.

- 2) If samples will stand for a while before filtration ideally, they should be stored in a fridge or cool dark place.
- 3) Gently agitate container before filtration to resuspend any sedimented material
- 4) Prepare petri slides (pictured below): We usually mark a piece of tape with the sample code (a number) and tape it onto the petri slide. Each sample should have a cruise code and unique number (e.g. CRE001, CRE002 etc).



- 5) Blanks (two types are necessary):
 - a. distilled water blank: Filter, dry and store 500ml of distilled water, in triplicate, following the protocol outlined in the next section NB: Distilled water blank only needs to be collected once per survey.
 - b. filter blank- Keep at least three unused filters from each box of filters used. Mark the box 1, 2 etc and note on the info sheet which samples the blanks correspond to in the line filter box number (see example below).
- 6) When changing box make a note of info sheet of which sample number begins with a new box. We need to know which samples come from which box of filters for correcting the blank accordingly. Write down the filter batch number (see example of infosheet below):

Sample no	Station	Depth (m)	Date	Volume (ml)	Filter box number	Filter type	Comments
cre097	1	1500	10.05.	4	Box 1	0.6 PC	f.ex. starting new filter
cre098	1						blank box 2
cre099	1						blank box 2
cre100	2						blank box 2
cre101	2						Box 2 starts
cre102	2						

For filtration:

- 1) Use 47mm 0.6 μ m (or selected pore size) polycarbonate filters in triplicate
- 2) Always note filtered volume on info sheet. It is OK to adjust volumes as needed, as long as the information is noted.
- 3) Before filtration gently agitate sample to resuspend particles
- 4) Filter selected volume using glass filtration funnels and collectors NB if there is a lot of material on the filter consider decreasing volume
- 5) When filtering is almost complete rinse filter with 5ml distilled water using pipette
- 6) Let filters air dry on sheet of paper or bench liner sheets.
- 7) Filters should be "weighed down" on one edge using labelled filter holder (see picture on the right)
- 8) Plastic box or other cover should be used to cover filters while drying,
- 9) Once filters are dry (for PC a couple of hours is more than enough), place in labelled filter holder and box

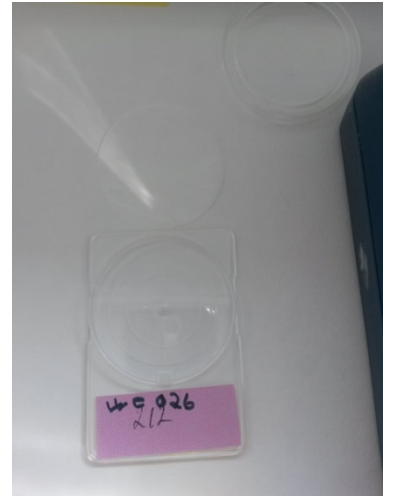

Important tips:

- 1) Flat forceps should be used to avoid damaging filter
- 2) Filter must be as centered as possible on the funnel. If the material is towards the edge of the filter it may result in a blank area of the filter measured in the XRF
- 3) When rinsing filter, pour the distilled water down the sides of the funnel to avoid redistribution of the material. If you forget to rinse, make a note of it. Rinsing removes salt crystals from the filter, which interfere with the measurement of salts (obviously). Other elements are measured even if you forget to rinse.
- 4) There should not be any water left on the filter, dried drops create a lot of noise in the XRF
- 5) Filter should not be left empty under vacuum for too long, cells will break
- 6) Depending on the temperature, drying of PC filters can take ca 15 mins to two hours.

→ **Sample storage/ shipment address:** Samples must be stored at room temperature, in their box. Under no circumstances should the samples be

refrigerated or frozen. Ship to operators address at end of cruise. No special requirements for shipping.

Ship to:

Institutt for biovitenskap, Biologen
Thormøhlens gate 53A, 2. etg
5006 BERGEN

7.12 INORGANIC NUTRIENTS

Measured parameter: Inorganic nutrients

Method responsible: Melissa Chierici (IMR, melissa.chierici@hi.no)

Description of parameter:

Methodological description:

→ **Special requirements/gear:**

→ **Sampling depths:** Standard depth and at deeper stations in addition:
5000, 750, 1000, 1500, 1750, 2000, 2500, 3000, 3500, 4000 m

→ **Chemicals used:** Chloroform: Triklormetan

Materials:

- Sampling bottles: Vials PE 25 ml.
- Boxes: Cardboardbox for storage of 100 pc of samples
- Dispenser: automaticpipette 0,2-1,0mL
- (remember adapter to 500mL chloroform bottle)
- Chloroform: Triklormetan for spectrophotometry (Uvasol) Merck no: 2447.0500.
- NB! Chloroform shall be treated with caution!

Method:

- Use labelled sample vials and add the number on the CTD-Rosette samplelist.
- Sampling: Rinse the bottles and cork with water from the appropriate Niskin flask at least 3 times before filling up. Fill the bottle, but leave a little room left for preservation. Use only new and clean scintillation bottles.

Preservation after sampling:

- 1) Preserve the samples with 200 μ L (0.2 mL) chloroform using an automatic pipette. Check that it is set on the correct volume. Test the pipette before preserving the samples to ensure that dosing takes place. Keep the equipment clean to avoid contamination!
- 2) Keep cool! Keep the preserved samples in the fridge in the dedicated cardboard boxes, label with cruisename/number, date.

SHORT VERSION:

1. Make sure the vials are numbered
2. Rinse vial and cap with water from the sampled Niskin 3 times before filling up leaving some headspace for preservation
3. Add 0,20mL (200 microliter) chloroform
4. Place the samples in fridge/cool storage in boxes

→ **Sample storage/ shipment address:** Samples have to be transported using cold freight and they should not be in room temperature or more for more than a few hours (1-3 hrs).

7.13 WATER COLUMN SAMPLING FOR ALGAL PIGMENT CONCENTRATIONS (CHLOROPHYLL *a*, PHAEOPIGMENTS)

Measured parameter: Algal pigment concentrations (Chlorophyll *a* and phaeopigments) from the water column

Method responsible: Rolf Gradinger (UiT, rolf.gradinger@uit.no), Anna Vader (UNIS, anna.vader@unis.no)

Description of parameter: Quantification of algal pigment concentration (chlorophyll a, phaeopigments; in $\mu\text{g L}^{-1}$) using the fluorometric acidification method (see separate protocol for measurements).

Methodological description:

→ **Special requirements/gear:** Avoid any direct sun light or strong light exposure of samples during any part of the sampling process because algal pigments are sensitive to light. For example, use plastic sampling bottles wrapped in tin foil.

→ **Sampling depths:** Standard depths (and deep chlorophyll fluorescence maximum; as detected by *in situ* fluorescence profile; only if present and significantly $\pm 5\text{m}$ different from standard depths). One sample per depth as standard.

→ **Chemicals used:** Methanol

Method:

- 1) Lower CTD mounted fluorescence profiler to below 100m (or bottom depth if shallower) to determine the presence/absence of a DCM.
- 2) Collect seawater (250 ml to 2l, depending on expected pigment concentration) from the Niskin bottles from standard depths and potentially DCM down to 100 m. Rinse the plastic sampling bottle with sample water three times (~100 ml in total, depending on water budget) before collecting the sample.
- 3) Store plastic bottles in dark and cold location until time for filtration; filtration should occur within one hour (the faster the better).
- 4) Remember to gently mix the bottle (turn upside down for a couple of times) before filtering to ensure that no particles settle down (results in uneven concentration if subsampling the sampling bottle).
- 5) Be sure to have placed the non-combusted Whatman GF/F filter (typically 25mm, depending on filtration rig) in the middle of the filter holder and that the funnel is thoroughly placed on top of it (if something is leaking the exact volume filtered or the filtration area on the filter is not known – these are needed for the calculations later).
- 6) Filter ca. 1x 50-2000 ml (depending on biomass – a light colour on the filter is enough) from each depth through 25 mm GF/F filters and 10 μm Polycarbonate

filters. Too much volume can result in clogging of the filter, too little volume can cause poor readings on the fluorometer.

- 7) Use low vacuum pressure (about -30 kPa). Always have the valve of the filtering funnel closed before turning the pump on or off.
- 8) Cover the funnels with tin foil while filtering. If you expect to filter 1 L or 2 L, you can place the plastic sampling bottle directly onto the funnel and let it run until empty. Ideally the 0.5 and 1 L mark should be indicated on the plastic sampling bottles prior to the sampling.
- 9) Rinse the funnel with GF/F filtered seawater (collect filtered sea water from previous filtrations into squeeze bottle) once the sample has been filtered. Do not let the filters dry out, close the valve.
- 10) Use forceps to fold the filter once and then place it into the plastic tube for Chl a extraction (10 ml Polypropylene (PP) tubes or reusable »Dramsglass« tubes with labelled plastic lids).
- 11) Label the PP tube with a cryomarker with sample ID. **NOTE: Sample ID rules for AeN TBD.**
- 12) Cover the sample labelling on the extraction tubes with transparent scotch tape because the solvent (methanol) will remove all markers.
- 13) Rinse the filtration equipment with MilliQ before the next sample. Cover filtration funnel with tin foil when not in use (to avoid dust).
- 14) Prepare samples in PP tubes for extraction with organic solvent if samples can be processed the next day (see separate document for details, preferred way).
- 15) If samples can't be measured the next day, samples in PP tubes should be shock-frozen in liquid nitrogen in a Dewar container (e.g. 2l) immediately after filtering and transferred to a -80°C freezer for storage once all samples from one station have been filtered. Wrap PP-tubes in tin foil prior to long term storage. Store all samples from one station within one Ziplock bag and label Ziplock bag with station ID, sample IDs and "Algal pigment samples."



Fig. 7.13-1 Example of a filtration set-up.

7.13.1 Measurements of algal pigment concentrations (chl *a*, phaeopigments) based on samples from water column and sea ice

Measured parameter: Algal pigment concentrations (chl *a*, phaeopigments) from the water column and sea ice

Method responsible: Rolf Gradinger (UiT, rolf.gradinger@uit.no), Anna Vader (UNIS, anna.vader@unis.no)

Description of parameter: Quantification of algal pigment concentrations (chl *a*, phaeopigments) (in $\mu\text{g L}^{-1}$) using the fluorometric acidification method.

Methodological description:

→ **Special requirements/gear:**

- Approx. 1 m bench space for Turner Design AU10 fluorometer,
- potentially fume hood for organic solvent addition to Polypropylene (PP) tubes, waste containers for organic solvent and HCl mixture after measurements.
- Waste container for gloves.

- Nitrile lab gloves recommended (to avoid potential LATEX allergic reactions).

→ **Sampling depths:** Standard depths (according to 3.2)

→ **Chemicals used:** Methanol, HCl

Method:

- 1) **Work as dark as possible.** Fluorometer should be in the darkest possible space, potentially wearing a red head lamp.
- 2) Add 5 ml methanol to the PP tube containing the GF/F /Polycarbonate filter. Use a dispenser, put a lid on the tube and cover with tin foil or store in black box/bucket with or cardboard box.
- 3) Extract in the dark “over night” (12 hours minimum, 24 hours maximum) in a refrigerator between 0 and 4 deg C. NB: Note the start and end time of extraction period.
- 4) Turn on fluorometer (model AU 10) at least 10 min before taking the first measurement. For greater details regarding Turner fluorometers, you can check the company website recommendations for chlorophyll measurements.
- 5) Check that the fluorescence reading of the fluorometer is at Zero, using pure methanol.
- 6) Vortex the tube for a few seconds and **let the sample adjust to room temperature** before fluorometer reading.
- 7) Transfer the sample to a clean borosilicate cuvette and dry the cuvette on the outside using lense paper.
- 8) Place the cuvette in the cuvette holder of the fluorometer and wait until readings have stabilized. Press * button on fluorometer (see picture below), it will first show **Delay**, then **Average** and finally **Done** on the fluorometer display. Read the value on the fluorometer. This is the Rb value (Reading before acid addition).
- 9) Take the cuvette out of the cuvette holder and add 2 drops of 5% HCl using Pasteurpipette, cover the cuvette with parafilm and mix it gently 3 times. Wait ca 90 seconds, then take a second fluorescence reading with the fluorometer. This is the Ra value (Reading **a**fter acid addition).
- 10) Place all chemical waste in a labeled waste container bottle. Wash cuvette with clean methanol between each sample and let it dry (place upside down on tissue paper).

- 11) Remember: Before start, and in between (every 15 samples), use a methanol blank to check that cuvettes are clean and that the fluorometer blank reading is stable at zero for methanol.



*Fig. 7.13.1-1 Display and buttons of the Turner Design AU10 Fluorometer, * button is indicated by the red arrow*

Calculation of chlorophyll and phaeopigment concentrations:

For chlorophyll a - concentration C:

$$C = F_s (r/(r-1)) (R_b - R_a) V_{ex} / V_{sam}$$

where:

C = chlorophyll a concentration ($\mu\text{g/L}$),

F_s = response factor for the sensitivity setting S (see section calibration)

r = the before-to-after acidification ratio of a pure chlorophyll a solution (see section calibration),

R_b = fluorescence of sample extract before acidification

R_a = fluorescence of sample extract after acidification.

V_{ex} = extraction volume (L, 0.005L suggested)

Vsam= volume filtered sample (L)

For phaeopigment - concentration P:

$$P = F_s (r/(r-1)) (rR_a - R_b) V_{ex} / V_{sam}$$

For abbreviations, see chlorophyll a calculation above.

7.14 CONCENTRATING PROTISTS <10 µM BY VIVAFLOW FILTRATION

Measured parameter: Concentrating small protists by Vivaflow filtration

Method responsible: Bente Edvardsen (UiO, bente.edvardsen@ibv.uio.no), Luka Supraha (UiO, luka.supraha@ibv.uio.no), Karoline Saubrekka (UiO, karoline.saubrekka@ibv.uio.no)

Definition of parameter: Concentration of small protist cells <100 µm by tangential filtration (VivaFlow) for electron microscopy observations and for isolating cultures.

Methodological description:

- **Special requirements/gear:** Vivaflow Cartridge for protists, Masterflex pump with adjustable speed, cooling room (if not available, keep sample on ice). Fume hood for addition of fixative.
- **Sampling depths:** DCM in plankton, melt pond (ice stations)
- **Chemicals used:** 0.1 M NaOH 10% ethanol, 25% glutaraldehyde

Material:

- Vivaflow200 Cartridge for protistplankton with tubings (0.2 µm, PES)
- Masterflex pump
- Bottles 3L, 1L and 250 mL or the sample
- Canister that fit the 1L sample bottle surrounded with ice

- Falcon tube 50 mL x2
- 100 µm mesh sieve
- Funnel (that fits the sieve)
- Milli-Q water (MQ) in a 1 L bottle
- NaOH 0.1 M 500 mL
- EtOH 10% 500 mL
- Filtered seawater, FSW (0.2 µm) 500 mL
- Glutaraldehyde EM grade 25% and datasheet
- Automatic pipette 1 mL with tip
- Gloves of nitrile

Method:

1. Prepare the Vivaflow setup by placing the filtrate and retentate tubes into a waste tank and the feed tube into MQ water container.
2. Rinse the cartridge with 250 mL of MQ water.
3. Fill a 3 L water bottle with water sample prefiltered through ca 100 µm mesh sieve. (Store sample on ice if you are not in a cooling room and strap a cooling element – wrapped in some tissue – on each side of the cartridge).
4. Replace MQ water with sample and rinse the cartridge with 250 mL of sample.
5. Transfer some of the sample into a 1 L bottle. Put the retentate tube in the 1 L bottle with sample (on ice). Turn the speed to ca 40 mL/min. Refill sample when needed until all 3 L sample is used.
6. Concentrate the sample until about 200 mL remains.
7. Transfer the sample to a 200 mL glass bottle and then concentrate at reduced speed to ca. 45 mL.
8. Transfer the sample to a 50 mL Falcon tube.
9. Remove the filtrate tube and close the outlet to recirculate the sample for a few minutes. No change in volume should take place.
10. Remove the feed tube from the sample to collect all the material in the Falcon tube by running air through the cartridge.
11. Store the sample in a cool room for later processing.
12. Place the retentate tube and the opened filtrate tube in the waste tank and the feed tube in the FSW container. Rinse with 250 mL of FSW.
13. Rinse with 250 mL of MQ water.
14. Rinse with 50 mL of 0.1 M NaOH, then place all three tubes in a container with 0.1 M NaOH and recirculate for 20 min.

15. Rinse with 250 mL of MQ water.
16. Turn off the pump, detach the 3 tubings and close the outlets on the cartridge.
For storage longer than one day rinse and store with 10% EtOH in the filter.
Store cartridge in fridge.
17. Pour 14,4 mL of the sample to a 15 mL plastic centrifuge tube and add by automatic pipette 600 μ L 25% glutaraldehyde (EM grade, 1% final conc.) under a hood and using nitrile gloves.
18. Use 8 mL of sample to dilution cultures ([7.25](#)).

→ **Sample storage:** Concentrated samples should be kept in a cool and illuminated room at ca. 4 °C for further processing (microscopy etc).

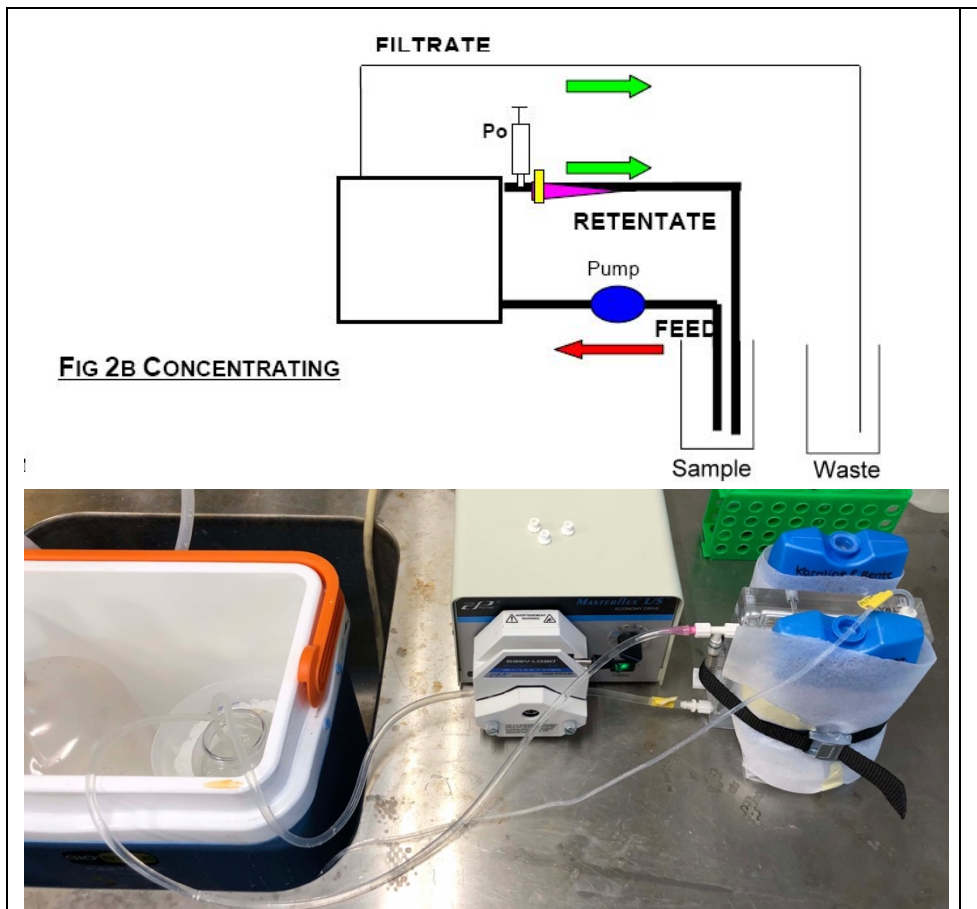

Fig. 7.14-1 Tangential flow filtration (TFF) concentration of phytoplankton (D. Vaultot: www.protocols.io)

Literature:

- Daniel Vaultot: Tangential flow filtration (TFF) concentration of phytoplankton. [protocols.io/doi.org/10.17504/protocols.io.krmcv46](https://doi.org/10.17504/protocols.io.krmcv46)

7.15 LIGHT MICROSCOPY PHYTOPLANKTON/PROTISTS

Measured parameter: Phytoplankton/protist abundance (in cells L⁻¹) using the Utermöhl method.

Method responsible: Rolf Gradinger (UiT, rolf.gradinger@uit.no), Philipp Assmy (NPI, philipp.assmy@npolar.no), Bente Edvardsen (UiO, bente.edvardsen@ibv.uio.no)

Description of parameter: Identification and quantification (abundance in cells L⁻¹) of phytoplankton/protists with an inverted light microscope using the Utermöhl method.

Methodological description:

- **Special requirements/gear:** Fume hood for addition of fixatives. Wear personal protection. Use waste containers as needed.
- **Sampling depths:** Standard depths at process stations 5, 10, 30, 60, 90 and DCM
- **Chemicals used:** hexamethylenetetramine-buffered formaldehyde and acidic Lugol's solutions.

Material:

- measuring cylinder 200 mL
- 6x 200 mL brown glass bottles, one per depth (see 9.1 for picture)
- hexamethylenetetramine-buffered formaldehyde (20%)
- glutaraldehyde (25%, EM grade)
- dispensers for the formaline
- Automatic pipette 1 mL with tips
- gloves of nitrile

Method:

1. Label six bottles (or 5 if 5m cannot be taken) with sample ID.
2. Wear gloves.
3. Fill ca 190 ml of seawater from each depth directly from the Niskin bottles into 200 ml measuring cylinder and transfer into the 200 ml brown glass bottles (see picture below). Rinse the cylinder with new sample between the samples and start with the deepest sample.
4. Under the fume hood add 0.8 mL glutaraldehyde (25%, EM grade, final concentration 0.1%), mix by gently turning the bottle up-side down three times.
5. Wait 5 min and then add 10 ml of 20% hexamethylenetetramine-buffered formaldehyde (final concentration 1%), mix.

→ **Samples storage/shipment address:** Store samples in cold room (formalin room) during the cruise. Ship the samples to NPI (and then to IOPAS) at end of cruise. Make sure that the bottles are safely packed for transport (hard-casing boxes with bubble-foil filling).

Literature:

- Edler, L.& Elbrächter, M. 2010. 2. The Utermöhl method for quantitative phytoplankton analysis. In: Karlsson, B. (ed.). Microscopic and molecular methods for quantitative phytoplankton analysis. IOC, UNESCO. Manuals and guides 55:13-20.
- Utermöhl, H. (1958). Zur Vervollkommung der quantitativen Phytoplankton-Methodik. Mitt. Int. Ver. Theor. Angew. Limnol. 9, 1-38.



Fig. 7.15-1 200 ml brown glass bottle

7.16 LIGHT MICROSCOPY LARGE PROTISTS/RARE TAXA

Measured parameter: Protist (>20 µm) and mesozooplankton abundance (in cells L⁻¹) of larger protists and small mesozooplankton

Method responsible: Rolf Gradinger (UiT, rolf.gradinger@uit.no), Philipp Assmy (NPI, philipp.assmy@npolar.no), Bente Edvardsen (UiO, bente.edvardsen@ibv.uio.no), Luka Supraha (UiO, luka.supraha@ibv.uio.no)

Description of parameter: Identification and quantification (abundance in cells L⁻¹) of larger protists (>20 µm) and small mesozooplankton (e.g. copepod nauplii and *Oithona*) with an inverted light microscope using the Utermöhl method and the enriched water samples. Please note that naked/delicate protists are not quantitatively retained by this method. Those taxa are counted in directly fixed non-enriched water samples.

Methodological description:

→ **Special requirements/gear:** Requires potentially an extra CTD cast due to the large volume needs. Fume hood for addition of fixatives. Wear personal protection for fixation and sample handling. Use waste containers.

→ **Sampling depths:** Standard depths: 5, 10, 30, 60, 90 and DCM and 200m (if available, depending on bottom depth)

→ **Chemical used:** hexamethylenetetramine-buffered formaldehyde, strontium chloride

→ **NOTE:** Suggested as sampling activity at all process stations only due to large water and time demand for sampling.

Method:

- a) Three Niskin bottles (10 L each) are closed per depth and their entire contents drained into a large carboy via long silicon tubing. Note the volume in the carboy.
- b) The contents of the carboys are then gently filtered over 20 µm mesh via a handnet

- c) Samples are washed off the mesh with GFF filtered seawater using a squeeze bottle and concentrated to approx. 90 ml (measure exact volume with 100 ml cylinder)
- d) Sample is filled into 100 ml brown glass bottle and 10 mL 20% hexamethylenetetramine-buffered formaldehyde (final concentration of 2%) add 3 ml strontium chloride stock solution.
- e) Wear personal protection when adding fixative!
- f) Label all bottles with sample ID.
- g) Store the samples dark and cold, do not freeze!

→ **Samples storage/shipment address:** Store samples in fridge or cool room during the cruise. Make sure that bottles are safely packed for transport (hard-casing boxes with bubble-foil filling).



Fig. 7.16-1 100 ml brown glass bottle (left hand side)



Fig. 7.16-2 Example of filtration tower (AWI-made; contact Uwe John) to concentrate large protists and small mesozooplankton (right side)

Literature:

- Throndsen J (1995) Estimating cell numbers. In: GM Hallegraeff DM Anderson AD Cembella. Manual on Harmful Marine Microalgae. Paris: UNESCO. pp. 63-80.
- Utermöhl, H. (1958). Zur Vervollkommung der quantitativen Phytoplankton-Methodik. Mitt. Int. Ver. Theor. Angew. Limnol. 9, 1-38.

7.17 METABARCODING (DNA AND RNA) OF PROTISTS AND PROKARYOTES

Measured parameter: Metabarcoding (DNA and RNA) of protists and prokaryotes

Method responsible: Anna Vader (UNIS, anna.vader@unis.no), Bente Edvardsen (UiO, bente.edvardsen@ibv.uio.no), Lise Øvreås (UiB, lise.ovreas@uib.no)

Description of parameter: Cells collected on filter, to be used for DNA and RNA isolation. Will result in OTU table of organisms.

Methodological description:

→ **Special requirements/gear:**

- Clean area for filtration/sample handling (KPH Filtration Lab)
- Fume hood for adding Glutaraldehyde and Lugol's
- Safety-sheets for Glutaraldehyde and Lugol's
- Minus 80°C freezer (and liquid nitrogen tank)

→ **Sampling depths:** 5m, DCM, "deep" (=15 m above-bottom), 200m (at deep stations)

→ **Chemicals used:** Glutaraldehyde EM grade 25% Merck and Lugol's

Method:

Important:

- Always use lab gloves (also when handling equipment, e.g. washing, storing).
- RNA degrades quickly due to hydrolysis and RNAses (which are everywhere!). Change gloves after touching surfaces, work quickly. Never leave RNA at room temperature.
- DNA is very stable. Cross-contamination of samples is thus an issue. Clean tweezers with ethanol before use. Change gloves between samples.
- Immediately after use, rinse all containers, tubes and filtration equipment with distilled water and leave to dry in clean area.
- Glutaraldehyde is very toxic, and should be added in fume-hood. Also keep waste in fume hood.

Filtration should be done in triplicate for each depth. In total $3 \times 7\text{L} = 21\text{L}$ of water should be filtered.

1. Prior to sampling: Print labels (size medium), enter sample information into xls log sheet and scan corresponding labels. Attach label to Sterivex filters, and put labeled Sterivex back into wrapping, making sure not to contaminate filter (use gloves). Label wrapping. Prepare pumps (insert tubing). Number the 10L waste containers (1, 2, 3 for each depth). Label 25L sample-carboys (one for each depth), and cover in dark garbage bags.
2. From each depth, collect appr. 25L of water from Niskins into 25L carboys.
3. Before connecting Sterivex filters, rinse tubes by pumping appr. 0.5L of sample water through tube.
4. Connect Sterivex filter to Luer-Lok fitting on tube (with a twist, see photo). The female Luer-lok is the inlet. Connect thin tubing to male outlet of Sterivex and insert other end into waste container. Tape tubing to container to prevent end from jumping out. Note starting time. Cover filter with foil to protect from light.
5. Set pump speed (flow rate 6 mL per sec) and direction (forward). Filter appr. **7 liters** of water through each Sterivex filter. Make sure the connections are tight and that there is no pressure build up (seen as considerable expansion of tubing and leaks)! Exchange filter if it shows signs of clogging.
6. Disconnect Sterivex filter from both tubes. Remove as much of remaining water as possible by pressing air through Sterivex filter using a 50 mL Luer-Lok syringe. Repeat until filter is empty.
7. Cap both ends of filter with inlet and outlet caps. Freeze filter in liquid N_2 or in -80°C freezer if nearby. Transfer to -80°C freezer for storage. Note end time.
8. Measure volume of filtered water from the 10 L waste containers using measuring cylinders. Note down volume filtered. If FSW is needed, e.g. for ice-samples: Collect filtered water in 20L containers, and store dark (garbage bag) in cool room.
9. Repeat procedure with next Sterivex filter (note that with three pumps with double pump-heads each, 6 filters can be run simultaneously).
10. For each filter, note down time of sampling, filtration volume, filtration time, size fraction, any deviation from protocol, observation (e.g. colour on filter) in log-sheet.

Extra procedure during bloom conditions (only surface and DCM samples, ID XX-B):

→ **Note:** this filtration is carried out to enrich for small cells that may be poorly represented due to clogging by larger cells. It should be done **in addition to standard sampling.**

1. Pour water sample through pre-filtration funnel equipped with 20 μm net.
2. Collect cells (from 20 μm flow-through) on labelled Sterivex filter using a peristaltic pump as above.
3. Cut out the 20 μm mesh from the funnel using a sterile scalpel and a tweezer washed in 70% EtOH, and transfer to 50 mL of sterile filtered seawater in a 50 mL Falcon tube. Shake tube gently to wash off organisms from mesh. Transfer 14 mL of sample to a 15mL Falcon tube and add 560 μL 25% glutaraldehyde (1% final), and 14 mL of sample to another 15mL Falcon tube and add 150 μL Lugol's (1% final conc.). The remaining is kept alive (ca 4°C in growth chamber or fridge) for microscopy and single cell PCR.

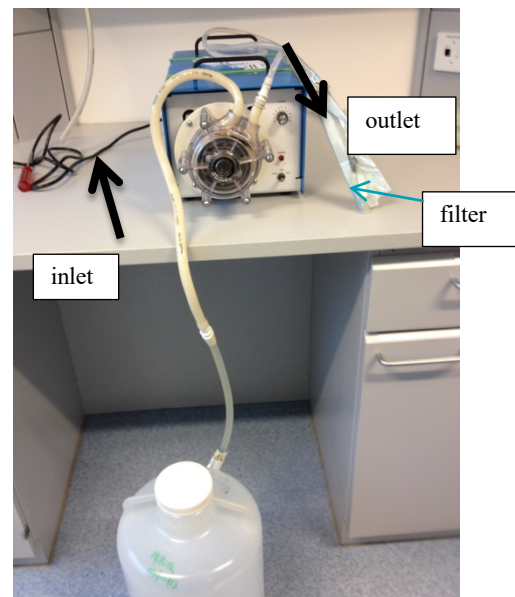

Fig. 7.17-1 Left: Sterivex filter with indication of inlet and outlet; Right: Peristaltic pump filtration set-up

→ **Samples storage/shipment address:** Store samples in minus 80°C freezer on ship (boxes labelled “metabarcoding/Anna Vader/UNIS”). Will be unloaded at UNIS by operator after each cruise (dry-shipper needed for transport).

Amount of water needed:

3 x 7000 mL (plus extra for rinsing, total 25L)

Sampling time:

appr. 1 hour per sample

Sample labelling:

Station, date, depth, volume

Parameters to be recorded:

Station, date, time of sampling (UTC), depth, size-fraction, volume, filtration time, protocol used (ID nr?), any deviations from protocol, filter colour, buffer added (volume and type), storage (i.e. LNG), operator, sample responsible

Sampling equipment (on “deck”):

- Niskin bottles (rosette)
- Clean silicon tubes to attach to the Niskin bottles to empty them, one per Niskin bottle, length ca 60 cm x 12
- Labelled 25L carboys in garbage bags (for collecting samples, x4)
- Sterile lab gloves (all sizes)
- Plastic funnels lined with 20 µm mesh (KC Denmark, for pre-filtration), labelled with depth

Filtration equipment (in lab):

- Peristaltic pump (ideally 3 with 2 pump-heads each, to filter 2 depths simultaneously)
- Tubing with Luer-Lok fitting
- 0.2 µm Sterivex filters, SVGPL10RC
- Syringes with luer-lok end (50 mL)
- Inlet and outlet caps for sterivex filters
- Zip-ties for tightening tube to Luer-Lok connection
- Sterile lab gloves (all sizes)
- 10 L containers to collect flow-through (x6)

- Liquid Nitrogen (LNG) tank (only if no -80°C freezer available)
- Measuring cylinder (1 L, x3)
- Labelling pens
- Measuring beakers (2 L, x4)
- 70% Ethanol in squeeze-bottle

During bloom conditions:

- 25% Glutaraldehyde
- Lugol's solution (see protocol for microscopy fixatives)
- Micropipettes for Glutaraldehyde and Lugol's and pipette tips
- 50 mL and 15 mL Falcon tubes

7.18 METATRANSCRIPTOMICS (MRNA) OF PROTISTS AND PROKARYOTES

Measured parameter: Metatranscriptomics (mRNA) of protists and prokaryotes

Method responsible: Anna Vader (UNIS, anna.vader@unis.no)

Description of parameter: Cells collected on filter, to be used for mRNA isolation. Will result in catalogue of gene activities.

Methodological description:

→ **Special requirements/gear:**

- Should be sampled at local noon (to allow comparison between stations).
- Samples need to be processed immediately
- Clean lab area for filtration and sample handling
- Minus 80°C freezer (and liquid nitrogen tank)

→ **Sampling depths:** 5m, only process stations

→ **Chemicals used:**

Method:

Important:

- Always use lab gloves (also when handling equipment, i.e. washing, storing).
- RNA degrades quickly due to hydrolysis and RNAses (which are everywhere!). Change gloves after touching surfaces, work quickly. Never leave RNA at room temperature.
- The mRNA composition changes according to the environment of the cell. Process samples immediately after collection, and try to keep sample at conditions resembling in vivo environment (i.e. light, temperature)
- Immediately after use, rinse all containers, tubes and filtration equipment with distilled water and leave to dry in clean area.

NOTE that filtration should be done on 5 filters simultaneously, to process samples as quickly as possible.

In total 5x(5-6)L=25-30L of water should be filtered.

1. Prior to sampling: Print labels (size medium), enter sample information into xls log sheet and scan corresponding labels. Attach label to Sterivex filters, and put labeled Sterivex back into wrapping, making sure not to contaminate filter (use gloves). Label wrapping. Prepare pumps (insert tubing). Number the 10L waste containers (1, 2, 3, 4 and 5).
2. Collect 35L of water from Niskins into two 25L clean carboys.
3. Before connecting Sterivex filters, rinse the tubes by pumping appr. 0.5L of sample water through each tube.
4. Connect Sterivex filter to Luer-Lok fitting on tube (with a twist, see photo). The female Luer-lok is the inlet. Connect thin tubing to male outlet of Sterivex and insert other end into waste container. Tape tubing to container to prevent end from jumping out. Note start time. Cover filter with foil to protect from light.
5. Set the pump speed (flow rate 6 mL per sec) and direction (forward). Filter **5-6 liters** of water through each Sterivex filter. Make sure the connections are tight and that there is no pressure build up (seen as considerable expansion of the tubing and leaks)! Exchange filter as soon as it shows signs of clogging.
6. Disconnect Sterivex filter from both tubes. Remove as much of remaining water as possible by pressing air through Sterivex filter using a 50 mL Luer-Lok syringe. Repeat until filter is empty.
7. Cap filter in both ends with inlet and outlet caps. Freeze filter in -80°C freezer (or liquid N₂ if no freezer nearby). Store in -80°C freezer. Note down end time.

8. Measure volume of filtered water from 10L waste containers using measuring cylinders.
9. For each filter, note down time of sampling (UTC), filtration volume, filtration time, size fraction, any deviation from protocol, observation (e.g. colour on filter) in log-sheet.
10. After filtering all samples, clean tubes by flushing distilled water through them (from tap), and hang to dry.

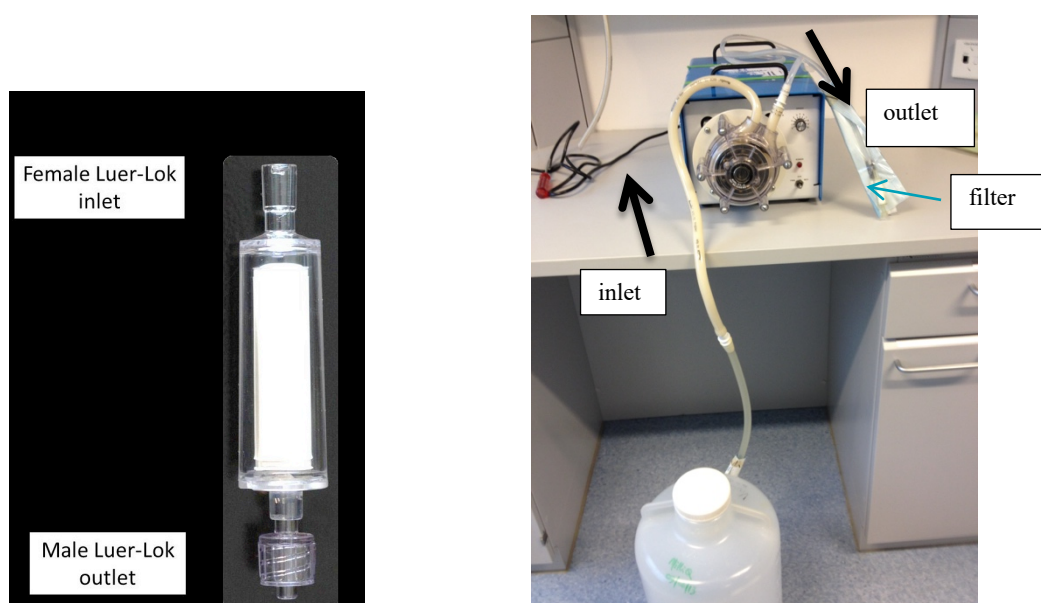

Fig. 7.18-1 Left: Sterivex filter with indication of inlet and outlet; Right: Peristaltic pump filtration set-up

→ **Samples storage/shipment address:** Store samples in minus 80°C freezer on ship (boxes labelled “metatranscriptome/Anna Vader/UNIS”). Will be unloaded at UNIS by operator after each cruise (dry-shipper needed for transport).

Amount of water needed:

30L (plus extra for rinsing tubes, total 35L)

Sampling time:

appr. 30 mins

Sample labelling:

Station, date, depth, volume

Parameters to be recorded:

Station, date, time of sampling (UTC), depth, size-fraction, volume, filtration time, protocol used (ID nr?), any deviations from protocol, filter colour, buffer added (volume and type), storage (i.e. LNG), operator, sample responsible

Sampling equipment (on "deck"):

- Niskin bottles (rosette)
- Silicon tubes to attach to the Niskin bottles to empty them, one per Niskin bottle, length ca 60 cm x 12
- Sterile lab gloves (all sizes)
- Labelled 25L carboys (x2) in garbage bags

Filtration equipment (in lab):

- Peristaltic pumps (3 with double pump-heads)
- Tubing with Luer-Lok fitting
- 0.2 µm Sterivex filters, SVGPL10RC
- Syringes with Luer-Lok end (50 mL)
- Inlet and outlet caps for Sterivex filters
- Sterile lab gloves (all sizes)
- 10L containers to collect flow-through (x5)
- Liquid Nitrogen (LNG) tank (only if no -80°C freezer nearby)
- Measuring cylinder (1L, x3)
- Measuring beakers (2L, x4)
- Labelling pens
- Zip-ties for tightening tube to Luer-Lok connection
- Squeeze bottle with 70% EtOH for cleaning

7.19 FILTRATION FOR DNA/RNA SAMPLES USING 0.22 μ M DURAPORE FILTERS

Measured parameter: Microorganisms are collected on a 0.22 μ m Durapore filter for molecular analyses

Method responsible: Oliver Müller (UiB, oliver.muller@uib.no)

Description of parameter/Aim: Water samples from experiments are filtered on 0.22 μ m Durapore filters to collect cells on the filter. The filter is later used for DNA and/or RNA isolation. The DNA/RNA can be used for different molecular analyses including community composition analysis which will have an OTU table of organisms as data output.

Methodological description:

→ **Special requirements/Gear:**

- Vacuum pump, 0.22 μ m Durapore filters,
- filtration bottles with 47mm funnel (including tubing and connections)

→ **Sampling depths:** Only water from experiments is used

→ **Chemicals used:** No chemicals

Method:

Filtration of water on a 0.22 μ m Durapore filters

Important: Work sterile!!!

- Always use lab gloves (also when handling equipment, e.g. washing, storing).
- Clean tweezers with ethanol between different filters.

- Transfer the respective volume (depends on the time point of sampling T0: 1L; T3: 200ml; T6: 500ml) from the experimental container (1L PC bottle or 0.5L whirlpack bag) into sterile bottles (1L).

- Use vacuum filtration systems and 0.22µm Durapore filters to collect biomass on the filters.
- Retrieve filters, transfer them into marked sterile Eppendorf tubes, flash-freeze in LiqN2 and store in -80°C freezer.

→ **Sample storage/shipping address:** Eppendorf tubes with Durapore filters inside are stored in cryoboxes in the -80°C freezer. The shipping address for all samples is:

Department of Biological sciences
 Att.: Oliver Müller/Gunnar Bratbak
 Thormøhlensgate 53A, 2. et.; 5006 Bergen
 Norway

7.20 FLOW CYTOMETRY SAMPLING

Measured parameter: Bacteria, virus and small protists abundance

Method responsible: Aud Larsen (Uni Research/Norce, aula@norcereasearch.no) / Gunnar Bratbak (UIB, Gunnar.Bratbak.uib.no)

Description of parameter: Samples for enumeration of bacteria, virus and small protists (primarily <10µm) by flow cytometry.

Methodological description:

→ **Special requirements/gear:** Liquid nitrogen for flash freezing and -80 freezer for storing of samples. Fume hood for use of fixatives.

→ **Sampling depths:** Standard depths at process stations 5, 10, 25, 50 75, 100 and 200m, DCM and deep sample (bottom -15m)

→ **Chemicals used:** 25% glutaraldehyde (EM grade)

Method:

- When preparing for station: Label each cryovial (2mL) with running number using cryomarker and/or use pre-printed label – NB: If using label make sure the label sticks after snap-freezed in liquid nitrogen.
- Under the fume hood, add 38 µl of 25% glutaraldehyde (EM grade) to each cryovial.
- Add sample directly from Niskin bottle into 20 ml scintillation vial (same as used for nutrients).
- Under the fume hood, pipette 1.8 ml of sample into 2 ml cryovial (3 vials per depth).
- Fix the samples for 2 h in a fridge.
- Snap freeze in liquid nitrogen.
- Store in cryobox at -80°C.

→ **Samples storage/shipment address:** Store samples in -80C during the cruise. Ship samples on dry ice using:

World Courier (Norway) AS
Industrivegen 20
2069 Jessheim (Oslo)

Tel: 47 6394 6200; Fax: 47 6394 6201; Email:
ops@worldcourier.no



OBS: Make appointment for pick up well in advance of docking at the end of the cruise and coordinate with shipping of other frozen samples (e.g. Sterivex filters)

Ship to:
Institutt for biovitenskap, Biologen
Thormøhlens gate 53A, 2. etg
5006 BERGEN

7.21 BACTERIAL BIOMASS PRODUCTION

Measured parameter: Bacterial production of carbon biomass (gC per volume per unit time)

Method responsible: Gunnar Bratbak (UIB, Gunnar.Bratbak.uib.no)

Description of parameter: Bacterial production of carbon biomass (gC per volume per unit time) estimated from incorporation of tritiated leucine ([2,3,4-³H] leucine).

Methodological description:

- **Special requirements/gear:** Isotope lab or area approved for use of ³H. Incubator if not *in situ* incubation. Operator must hold a radioisotope safety course certificate.
- **Sampling depths:** Standard depths at process stations
- **Chemicals used:** tritiated leucine, 100% TCA

Method:

- Use sterile 2 mL Eppendorf tubes labelled on top, 4 per sample (3 parallels + 1 blank)
- Dilute enough isotope for one experiment/incubation 1:10 in sterile saline (eye drops (physiological salt-water) ampules are convenient). Add 10 µL isotope to each tube to give a final concentration of 27µM leucine. *Volume added and dilution has to be recalculated for every new Lot nr of isotope.*
- Start timer. For each sample (depth) add 1.5 mL water to 4 tubes and then 80µl 100% TCA to the blank. Close the tubes. Start each new sample with 30 sec intervals to keep track of the incubation time.
- Incubate in situ or at in situ temperature for 2 hours.
- Add 80µl 100% TCA to all samples (except blanks) following the same sequence as used for starting the incubations.

- Check that tube label is readable and store them in sequence in a cryobox. Label the cryobox and make a sample log sheet for the box where all samples are listed. Store the samples in the fridge and ship home for workup and scintillation counting as described in standard protocols.
- Clean the working area and perform wipe test.

→ **Samples storage/shipment address:** Store samples in fridge during the cruise. Ship to operators address at end of cruise following protocols for shipment of radioactive material.

Literature:

- Simon M and Azam F (1989). Protein content and protein synthesis rates of planktonic marine bacteria. *Mar. Ecol. Prog. Ser.* 51: 201-213.
- Smith DC and Azam F (1992). A simple, economical method for measuring bacterial protein synthesis in seawater using ³H-leucine. *Mar. Microb. Food Webs* 6: 107-114.
- Kirchman DL (1993). Leucine incorporation as a measure of biomass production by heterotrophic bacteria. In: *Current Methods in Aquatic Microbial Ecology* (P. Kemp, BE Sherr EB Sherr and JJ Cole, Eds). Lewis Publishers, Boca Raton, FL.
- Kirchman D (2001) Measuring bacterial biomass production and growth rates from leucine incorporation in natural aquatic environments. *Methods in Microbiology*. 30: 227-237

7.22 IRON CHLORIDE PRECIPITATION OF VIRUSES FROM SEAWATER

Measured parameter: Recover viruses from natural waters.

Method responsible: Ruth-Anne Sandaa (UiB, ruth.sandaa@uib.no)

Description of parameter: Recover viruses from natural waters via iron chloride precipitation.

Methodological description:

→ **Special requirements/gear:** -80 freezer for storing of samples.

→ **Sampling depths:**

- WATER: Chl a max (or 20m if not detectable) and deepest sample at process stations. At deep stations (> 1000 m) add one sample at 500 m. 2 parallel samples of 20L pr event.
- SEA ICE: Bottom 10 cm of 2-4 ice cores.

→ **Chemicals used:** FeCl₃, 0,1M EDTA-0,2M Ascorbate buffer (see recipe below)

Method:

WATER SAMPLES

- a) Use of Masterflex I/P pump with Easy Load head pump and Millipore Stainless Steel Filter Holder (Tripod):** Prepare pump and Tripod by mounting the tubing to the pump head (see Figure and Tripod assembly diagram below). Set occlusion adjustment to 3 and the pump in direction of the Tripod (see Figure). Open the air vent/relief valve on the tripod (handle in vertical position). Start the pump at low speed, tighten the occlusion adjustment if needed and let it run until only water and no air comes out of the air vent/relief valve and then close it (handle in horizontal position). Increase to pump speed to 10 (will give a flow rate of ca 400 mL per min). When the appropriate amount of water has been filtered, let the pump run with air to remove water from the Tripod, turn off the pump and open the air vent/relief valve before opening the Tripod to remove the filter.
- b) Filter 20 L of sample through 0.45 µm, 142mm Durapore filters into clean 20 L containers.** This is the water (filtrate) to be used for virus concentration, discard the filter.
- c) Prepare FeCl₃ stock solution (10g/L) by adding 20 mL MQ water to pre-weight 0.966 g FeCl₃ x 6H₂O in 50 mL falcon tubes.**
- d) Add 1 mL of the FeCl₃ stock solution to each 20 L of sample.** Shake vigorously for 1 min (roll the containers back and forth on the floor).
- e) Add additional 1 mL of the FeCl₃ stock solution to each 20 L of sample.** Shake vigorously for 1 min (roll the containers back and forth on the floor).

- f) Let the FeCl_3 treated water sit for 1h at room temperature to precipitate.
- g) Filter the FeCl_3 treated water using 1.0 μm , 142 mm polycarbonate (PC) membrane on top of a 0.8 μm , 142 mm Supor Membrane filter (support). Change the PC and the Supor filter 1-3 times during filtration if necessary (slow filtration rate, depending on biomass).
- h) Place all PC filters from the same 20L sample in one 50 mL Falcon tube, with the precipitate facing out. Discard the Supor filter.
- i) Prepare fresh 0.1M EDTA-0.2M Ascorbate buffer, pH 6.0-6.5 (See buffer recipe below)
- j) Add 20mL of 1x buffer to each of the Falcon tubes (precipitate from 20L seawater)
- k) Place tubes on a rotor o/n at 4°C.

ICE CORE SAMPLES

- Melt the ice, filter through 0.45 μm Durapore filters, measure the volume filtered and add the appropriate amount of FeCl_3 stock solution (100 $\mu\text{L/L}$) in c) and d), proceed as above.

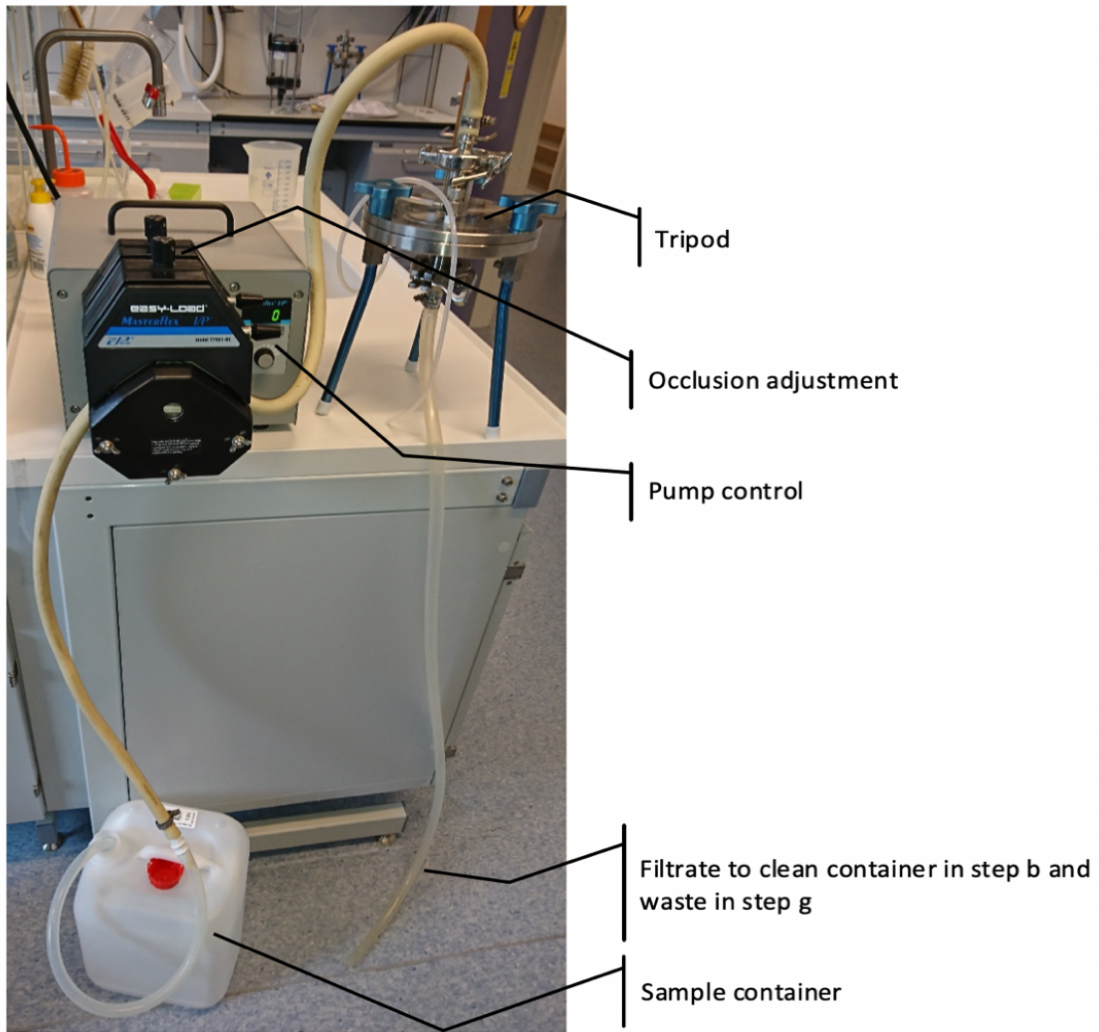

Fig. 7.22-1 Filtration set up for viruses using a Masterflex I/P pump with Easy Load head and a Millipore Tripod - Standing Stainless Steel Filter Holders (142 mm)

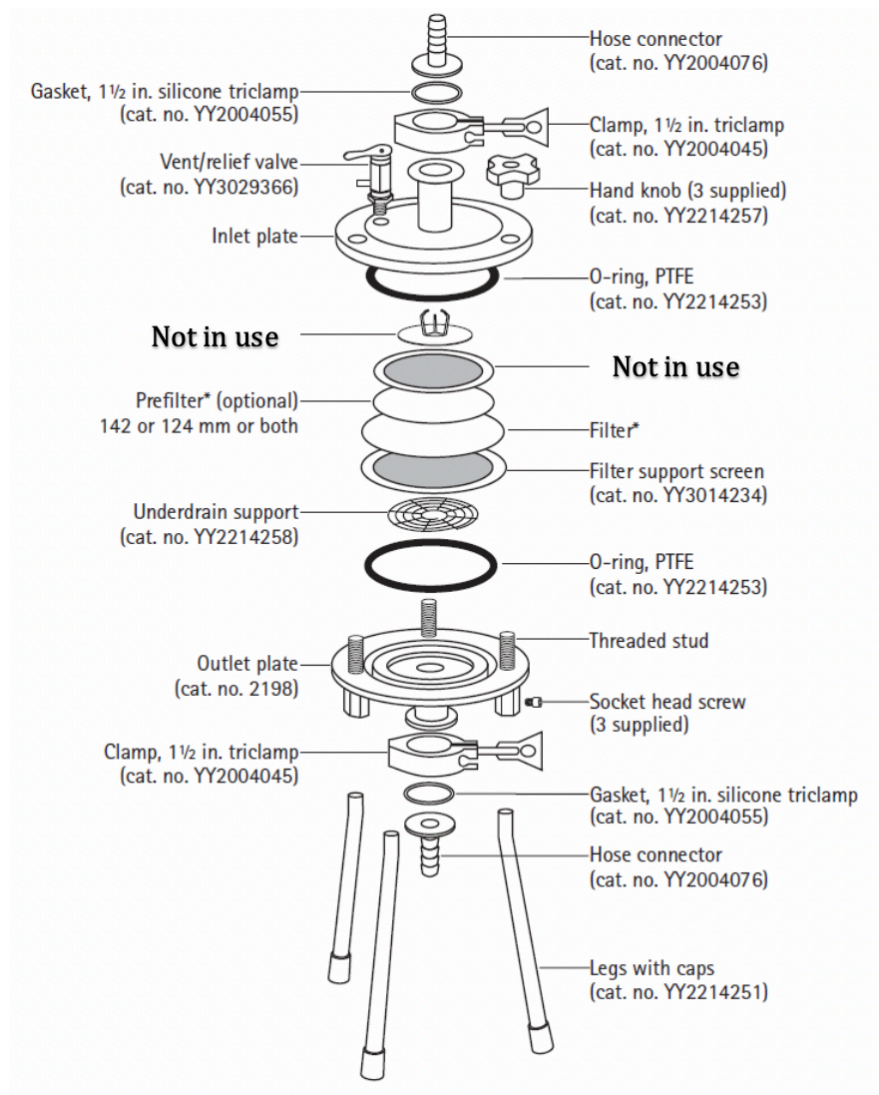

Fig. 7.22-2 142 mm stainless steel filter holder assembly diagram (© Merck Life Science).

→ **Samples storage/shipment address:** Store samples in -80 during the cruise and on dry ice during transport.

NOTE: Make appointment for pick up well in advance of docking at the end of the cruise and coordinate with shipping of other frozen samples (e.g. Sterivex filters)

Ship samples on dry ice using
World Courier (Norway) AS
Industrivegen 20
2069 Jessheim (Oslo)
Tel: 47 6394 6200; Fax: 47 6394 6201; Email: ops@worldcourier.no

Ship to:
Institutt for biovitenskap, Biologen
Thormøhlens gate 53A, 2. etg
5006 BERGEN

Buffer preparation: 0,1M EDTA-0,2M Ascorbate buffer, pH 6.0-6.5 – 100ml

Chemicals:

- 0.966 g $\text{FeCl}_3 \times 6\text{H}_2\text{O}$ in 50 mL falcon tubes (20 mL MQ gives 10g/L Fe Stock Solution)
- 10g NaOH (50ml MQ gives 5N NaOH)
- 1.51g Tris-base
- 3.72g $\text{Na}_2\text{-EDTA}$ dihydrate
- 4.07g MgCl_2 .
- 3.52g of ascorbic acid
- HCL 5N
- pH paper

Buffer preparation:

- Dissolve 1.51g Tris-base in 80ml Milli Q water.
- Dissolve 3.72g $\text{Na}_2\text{-EDTA}$ dihydrate into solution. (For info: pH will be ~10.0)
- Once EDTA is in solution, dissolve 4.07g MgCl_2 . (For info: pH will drop to ~8.0)
- Add 3ml of 5N NaOH. (For info: This will drop the pH to ~4.5 and the solution will become cloudy which indicates that the EDTA is coming out of solution.)
- Dissolve the reductant (3.52g of ascorbic acid or 2.52g of oxalic acid). (For info: The pH will increase to ~8.3 and the solution will clear up.)
- Once the reductant is in solution, add the last 1ml of 5N NaOH.
- Check the pH using pH paper (the buffer should be at pH 6.0 - 6.5). The solution may need some minor adjusting with NaOH or HCl to achieve a pH of 6.0. pH 6.0 is ideal for good recovery of viruses.

- Check the volume and add MilliQ water for a total volume of 100ml.
- Store the buffer in the dark (bottle wrapped in foil) and visually inspect prior to use. It should be clear without precipitates. At this point, 10-15ml of buffer can be sacrificed for a final pH check using a pH meter (if available).

The buffer will start to change colour after about 24 hours. It is okay to use if slightly discoloured, but do not use after about 36 hours (eventually the buffer will turn almost orange!).

Literature:

- John, S, Poulos, B and Schirmer C. 2015, Ion Chloride Precipitation of viruses from seawater, Protocols.io
- <https://www.protocols.io/view/Iron-Chloride-Precipitation-of-Viruses-from-Seawat-c2wyfd>

7.23 VIRAL PRODUCTION AND DECAY (REV.1)

Measured parameter: Viral production and decay

Method responsible: Ruth-Anne Sandaa (UiB, ruth.sandaa@uib.no)

Description of parameter: Measure rate for viral production and degradation

Methodological description:

→ **Special requirements/gear:** -80C freezer for storing of samples.

→ **Sampling depths:** Chl a max (or 20m if not detectable) and deepest sample at process stations

→ **Chemicals used:** 0.5 M NaOH, Ethanol

Method:

Prepare two Vivaflow 200 cassettes, one 0.2 µm PES and one 100 000 MWCO PES, and flush the systems with 500 mL MQ water as described (see *Vivaflow*

*Assembly and operation, Fig. 7.23-1). After use wash cartridges according to producer manual and store 10 % EtOH (4°C) (see *Cleaning and storage of Vivaflow* below)*

Concentration of prokaryote and prokaryote free water (0.2 µm cartridge)

- Flush the Vivaflow 0.2 µm PES cartridge with 50 ml of a 500 mL sample
- Start concentrating the sample while collecting the prokaryote-free filtrate.
- At approx. 50 mL, turn off the pump and transfer the sample to a 50 mL Falcon tube before continuing concentration to approx. 20 mL.

Virus-free water (100 000 MWCO cartridge)

- Flush the Vivaflow 100 000 MWCO PES cartridge with 50 ml of a 200 mL aliquot of the prokaryote-free filtrate.
- Collect 150 mL of virus free filtrate

Virus production

- Dilute the prokaryote concentrate to 150 mL with virus-free filtrate
- Distribute ca 50 mL to each of three Falcon tubes
- Incubate at *in situ* temperature in the dark.
- Collect, fix and store 1.8 mL samples for viral and bacterial counts according to the FCM protocol at time zero and after approx. 3, 12, 24 and 48 h of incubation (make notes of exact incubation time).

Viral decay

1. Distribute 50 mL of the prokaryote-free water to each of three Falcon tubes
2. Incubate at *in situ* temperature in the dark.
3. Collect, fix and store 1.8 mL samples for viral and bacterial counts according to the FCM protocol at time zero and after approx. 3, 12, 24 and 48 h of incubation (make notes of exact incubation time).

Vivaflow Assembly and operation

1. Set up the system as illustrated below. Note the positioning of the flow restrictor on the return line.
2. Place 500 ml deionised water in a suitable reservoir and pump liquid through the system to purge any air pockets. The recirculation rate should be 200–400

- ml/min, and suitable flow should exit the filtrate line. If used, the pressure indicator should read approximately 2.5 bar.
3. Allow 400 ml to pass into the filtrate vessel. Check for any leakage at tubing connection points.
 4. Drain the system and empty or replace the filtrate vessel

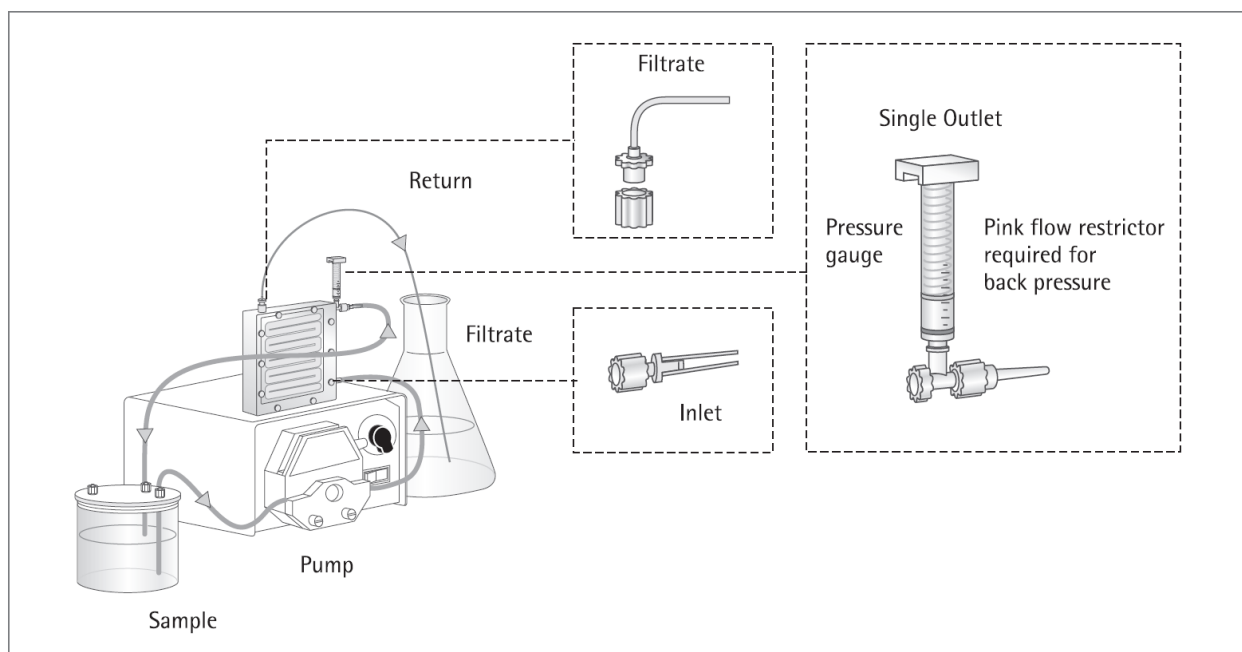

7.23-1 Vivaflow 50R and Vivaflow 200 set up (@Sartorius AG, provided by courtesy of Sartorius AG)

Cleaning and storage of Vivaflow

Cleaning

1. Flush the system with 200 ml of deionised water with the filtrate going to waste.
2. Place the feed, return and filtrate lines in a container with 250 ml 0.5 M NaOH (cleaning solution).
3. Recirculate at 50–100 ml/min for 30–40 minutes.
4. Drain the system and recirculate 250 ml of deionised water through the system for 5–10 minutes.
5. Drain and discard rinse solution and flush with a further 500 ml of deionised water with the filtrate going to waste. The system is now ready for further use.

To store Vivaflow after cleaning, fill module with deionised water and 10% ethanol. Seal inlet, outlet and filtrate ports and refrigerate at approximately 4°C.

For full description see Sartorius Lab Instruments Publication No.: SLU6097-e160609, Directions for Use Vivaflow 50 | 50R | 200

→ **Samples storage/shipment address:**

Store samples in -80C during the cruise. Ship samples on dry ice using

World Courier (Norway) AS
Industrivegen 20
2069 Jessheim (Oslo)
Tel: 47 6394 6200; Fax: 47 6394 6201; Email: ops@worldcourier.no

NOTE: Make appointment for pick up well in advance of docking at the end of the cruise and coordinate with shipping of other frozen samples (e.g. Sterivex filters)

Ship to:

Institutt for biovitenskap, Biologen
Thormøhlens gate 53A, 2. etg
5006 BERGEN

Literature:

- Weinbauer, Rowe, Wilhelm, 2010, Determining rates of virus production in aquatic systems by the virus reduction approach., MAVE, chapter 1 pp 1-8
- Matteson, A.R., Budinoff, C.R., Campbell, C.E., Buchan, A., Wilhelm, S.W. Estimating Virus Production Rates in Aquatic Systems. J. Vis. Exp. (43), e2196, DOI: 10.3791/2196 (2010).URL: <http://www.jove.com/video/2196/>

7.24 COCCOLITHOPHORES AND OTHER SMALL PLANKTON FOR SEM

Measured parameter: Qualitative and quantitative analysis of coccolithophores and other small plankton

Method responsible: Luka Supraha (luka.supraha@ibv.uio.no), Bente Edvardsen (bente.edvardsen@ibv.uio.no), Karoline Saubrekka (karoline.saubrekka@ibv.uio.no)

Special requirements: Vacuum filtration system for 4 samples and 25mm filters with a peristaltic pump.

Sampling depths: Standard depths as for quantitative phytoplankton samples (5m, DCM, 200m and bottom).

Methodological description

Material:

- Polycarbonate filters (25mm, pore size 0.8 μm)
- Cellulose nitrate membrane filters (MCE, 25mm, pore size 3 μm)
- Vacuum filtration setup for 25 mm filters (rack and funnels with funnel holders for 4 samples, peristaltic pump with Masterflex tubing).
- Measuring cylinder (250 mL) x 4
- Plastic bottle (1L) x 4
- Tweezers, x2
- Millipore dishes (50 mm) for storing filters
- Plastic pipette, 2 mL
- Waterproof marker

Method:

- Use clean and dry equipment.
- Mount the filtration unit. Add 2 mL sterile seawater on top of the scint. Place the cellulose nitrate membrane on the scint, and then the polycarbonate filter on top of it and turn on the vacuum pump. Filters should be well aligned and without wrinkles.
- Collect 1 liter of sample from the Niskin flasks in a plastic bottle. Turn the bottle gently five times (do not shake it) to ensure even distribution of material.
- Fill the measure cylinder with the desired volume, 250 mL – 1 L, depending on cell density. The material should be visible, but not be a thick layer on the filter.
- Pour the water gently into the filtration funnel. Turn on the pump. The flow should be steady and not too fast. Filter until dry. Write down the volume filtered per sample.

- Carefully transfer the polycarbonate filter to a labeled Millipore filter dish (sample side up). The filters should be dried in room temperature for >2 h. The filter dishes with filters should be partially covered with a lid while drying.
- Rinse all the equipment with freshwater and wipe off the tweezers between samples.

→ **Samples storage/shipment address:** Once dried, the filters should be stored in closed Millipore dishes or Petri dishes. During transport and storage, it is important to keep the filters with the sample side up. The samples will be analysed at the University of Oslo.

Literature:

- Bollmann J, Cortes MY, Haidar AT, Brabec B, Close A, Hofmann R, et al. Techniques for quantitative analyses of calcareous marine phytoplankton. *Mar Micropaleontol.* 2002;44(3-4):163-85.
- Šupraha L, Ljubešić Z, Mihanović H, Henderiks J. Coccolithophore life-cycle dynamics in a coastal Mediterranean ecosystem: Seasonality and species-specific patterns. *J Plankton Res.* 2016;38(5).

7.25 MICROALGAL DIVERSITY BY CULTURING (SERIAL DILUTIONS)

Measured parameter: Microbial diversity

Method responsible: Bente Edvardsen (UiO, bente.edvardsen@ibv.uio.no), Luka Supraha (UiO, luka.supraha@ibv.uio.no).

Definition of parameter: Isolation of microalgal cultures by serial dilutions

Methodological description:

→ **Special requirements:** Cold room or incubator with plant light

→ **Sampling depth(s):** A) DCM concentrated by Vivaflow and net samples (50-0m) from all process stations. B) from meltponds, under ice 0.5 m net sample and ice core (0-10cm) at ice stations.

→ **Chemicals used:**

Material:

- Multiwell cell culturing plates (96 wells, TPP), with 1 mL wells. Each plate can be used for 1-4 samples. Ca 15-20 per cruise.
- Lids for all the plates.
- Suitable algal medium (e.g. IMR ½ or L1) with salinity similar to the sea water sample (30-34 PSU). For isolation of species thriving in low nutrient waters the strength of the medium can, to start with, be reduced to 1/2-1/10 of the full medium. Dilute, if possible, the medium with sterile sea water from the actual locality.
- Automatic pipettes -1000 µL and 200 µL with tips
- Sip lock bags x7
- Fresh samples, concentrated or non-concentrated
- Large cooling element and 2 smaller
- Cooling bag

Method:

1. Distribute 900 µL algal medium to each well with the 1 mL automatic pipette. Keep the plate at the same temperature as the water sample, e.g. by placing the plate in the fridge before use or on a cooling element. Mark a line on the lid of the plate between column 6 and 7, and label the plate with the sample ID on each side.
2. Add 100 µL of algal sample to the first well in all rows (column A-H).
3. Mix carefully the diluted sample in the first well in the row by pipetting up and down slowly with a 1 mL pipette. Transfer 100 µL from well A1 to A2 with the 100 or 200 µL pipette. Mix, transfer 100 µL from well A2 to well A3 etc, all the way to well A6. Do the same with rows B-H with the same sample. Do the same with sample 2, after turning the plate 180°, starting from the left side (in well H12 and ending at well A7).

4. Put on loosely a lid fitting the plates and then in a plastic bag with sip lock. Place the plates in a cooling room or incubator with plant light (ca 30-50 $\mu\text{mol photos m}^{-2} \text{s}^{-1}$) at suitable temperature (ca 2-4°C) for 2-4 weeks.
5. During transportation press the lid in place to close it, and pack them in a cooling box with cooling elements and bubble plastic to avoid tilting. Send the cooling box as luggage on the airplane you take.
6. Back in the lab (UiO), open up the lids from the plates and place the plates in plastic bags to allow gas exchange, but avoid evaporation. Place the plates in a cooling room (4°C) with suitable illumination.
7. After ca 4 weeks, check the plates under an inverted microscope. From the wells with colour, ca 50 μM is pipetted onto a Petri dish and examined under the microscope at 100-400x magnifications. If the culture is monoalgal and of interest, transfer it to a well in a 24 wells plate with 2 mL algal medium placed in a plastic bag. Finally, a monoalgal strain is placed a 20 mL glass tube with 15 mL suitable algal medium.

→ **Samples storage/shipment address:** Multiwell plates containing serial dilutions should be kept in a culture room or an incubator with plant light at low temperature (4°C). During transportation put on a fitting lid and place in a cooling box with cooling elements and fill up with packing material to avoid tilting. Monoalgal cultures can be deposited and maintained at the Norwegian culture collection of algae (NORCCA) at UiO.

Literature:

- Andersen, R.A. & Kawachi, M. 2005. Traditional microalgae isolation techniques. In: Andersen, R. A. (ed). Algal Culturing Techniques. Elsevier Academic Press, 578 p.

7.26 DETERMINATION OF *IN SITU* PRIMARY PRODUCTIVITY RATE \ USING THE 14C METHOD

Measured parameter: *In situ* primary production rate

Method responsible: Rolf Gradinger (UiT, rolf.gradinger@uit.no), Philipp Assmy (NPI, philipp.assmy@npolar.no), Marti Amargant Arumi (UiT, marti.a.arumi@uit.no)

Description of parameter: Determination of the production rate of organic material by phytoplankton under *in situ* conditions by using the ^{14}C method.

Methodological description:

→ **Special requirements/gear:** radioisotope container, permission to work with radioactive isotopes, in situ incubations through ice or deployed drifting buoys

→ **Sampling depth(s):** 5, 10, 20, 30, 40, 60, 90 m

→ **Chemicals used:** ^{14}C -sodium bicarbonate working solution (e.g. 20 $\mu\text{Ci/ml}$), Hydrochloric acid (HCl 6M and 1M), NaOH (6N), Ethanolamine, Scintillation cocktail Ecotone

Material:

- 1 Incubation bottles 250ml Polycarbonate
- Rope, buoy, carabiners
- GF/F filters
- Vacuum filtration manifold with waste bottles and vacuum pump and tubing
- Tweezers (2-3)
- Executor with fuming HCl (37%)
- Micropipets and tips (One of each: 1000 μl , 200 μl and 20 μl)
- Cylinder (100 ml)
- Rinsing bottles (3x)
- Scintillation vials
- boxes to store scintillation vials for further processing back on land
- Trays for radioactive work
- Gloves (nitril size dependend on operator)
- Paper towels
- Radioactive waste containers (solid, liquid)
- Absorbing bench paper
- Light sensor on CTD
- Go Flow bottles or Niskin bottles on CTD
- 2 glass duran bottles 0.5L
- ^{14}C -sodium bicarbonate working solution (e.g. 20 $\mu\text{Ci/ml}$)
- Hydrochloric acid (HCl 6M and 1M)

- NaOH (6N)
- Ethanolamine

Assumption: DIC determined by other group, otherwise additional sampling needed.

→ **NOTE:** Always wear safety goggles, a lab coat and gloves when working with ^{14}C and any hazmat (e.g. scintillation cocktail). Collect all chemical/radioactive waste in clearly labeled waste containers. Keep a clear protocol on how ^{14}C has been used. Do not mix radioactive waste with other chemical waste.

Method:

- 1) Preparation of incubation bottles/flasks
 - Use the provided 250ml culture tissue flasks. Rinse flasks between measurements with 10% HCl, followed by distilled water. Dry before re-use.
- 2) Taking of water samples/ice sample:
 - Water samples are taken at the same depth as sediment traps are deployed (5, 10, 20, 30, 40, 60, 90 m). This should be matched by Chl and POC data from the same depths. The selection of depth should cover the approximate light levels from >90 to ca 1% or less of surface PAR). PAR in the water should be determined during a CTD cast. If a Chl a maximum exists, one of the samples should be taken in the chl a max. If melt ponds exist on the ice, take one set of samples from the melt pond.
 - For water sample from ocean or for melt pond sample: Take one light and one dark bottle from each sampling depth. Rinse bottles three times before filling. Keep the samples as shaded/dark as possible during treatments.
 - For ice sample: take one complete ice core. Cut off and use only the bottom 1cm. Protect from direct sun light (black trash bag). Cut inside a dark tent. Crush the ice (likely it will be in small pieces anyway if skeletal layer present). Place the sample into a clean 500ml duran bottle. Add 400ml filtered sea water at 0-2degC from the surface. Shake to distribute the ice evenly and/or wait until it is melted. Use the melted sample as a water sample. Important: Note the final volume of the melted water sample to calculate the volume of the added ice sample. Take a subsample for chl a and POC.
 - Bring the samples in a dark container into the isotope lab for spiking.

- Note: make sure that for each sampling depth/melt pond/sea ice samples, also samples are processed for chl a, POC. Adjustment of sampling depths might be needed to match sampling by other groups. More important to cover the above given light profile range for the water column samples than precise depths.
- 3) Spiking with $\text{NaH}^{14}\text{CO}_3$ solution:
- Achieve a final concentration of $0.1\mu\text{Ci/ml}$ inside your incubation bottle. In case of low biomass in high Arctic samples you can also use a final concentration of $0.4\mu\text{Ci/ml}$ (e.g. Ferland et al. 2011, <http://dx.doi.org/10.1016/j.jmarsys.2011.03.015>).
 - Incubation bottles are filled with a measuring cylinder. The flasks should be filled up to the neck, leaving an air bubble in the flask. One dark flask from each original sample should be incubated. All places on the incubator wheel must be taken by bottles. So empty spaces should be filled with bottles filled with DI water.
- 4) Determination of total labelled carbon added:
- After mixing thoroughly add $250\mu\text{l}$ (x2) from each spiked bottle into 20ml scintillation vials which contain $250\mu\text{l}$ of ethanolamine. Keep at room temperature until measurement with scintillation counter. Prior to counting: add 10 ml of scintillation cocktail—shake the sample.
- 5) Incubation
- Incubate for 24 hours. Ideally incubation should go from dawn to dawn the next day to estimate net primary productivity. Attach the bottles with carabiners to the sediment trap rig for drifting incubations. For incubation in holes through the ice: use a bottom weight and a line with loops to attach the carabiners. Cover the hole in the ice with the white disk. Secure the line with two ice screws.
- 6) Filtration: particulate and dissolved PP
- After incubation the flask contents are filtered immediately. Maintain darkness or very low light intensities while processing the samples. In case of high algal biomass or high sedimentation load it might be needed to filter a subsample. A defined portion should be taken and filtered.
 - Glass-fibre filters (GF/F, $\varnothing 25\text{ mm}$) should be used. To avoid any contamination of the filter edges, prewetted filters should be used. The suction pressure

$$dP/dt (\mu\text{g C}\cdot\text{L}^{-1}\cdot\text{hr}^{-1}) = \frac{\text{dpm (a)} \cdot \text{total}^{12}\text{C O}_2 \text{ (c)} \cdot 12 \text{ (d)} \cdot 1.05 \text{ (e)} \cdot k_1 \cdot k_2}{\text{dpm (b)}}$$

should not exceed 30 kPa during filtration. The filters should be rinsed once with a small volume (5 ml) of filtered seawater from the original sample (use filtrate of the chlorophyll-a measurement!). Note: This rinsing step is debated, and some groups do not rinse the samples.

7) DOC production samples

- If DOC is going to be measured use the following sub-sampling from the spiked sample:
- Filter 3ml of the incubation from each incubation bottle through a GF/F or 0.2 or 0.4 μm filter into a scintillation vial. You can use a Syringe filter for this. Add 500 μl of 6N HCl. Leave in the fume hood for 24 hours to release of $^{14}\text{CO}_2$. Neutralize the sample with addition of 500 μl of 6N NaOH. Add 15ml of scintillation cocktail for immediate measurement in scintillation counter.

8) Post-Processing of particulate production filters:

- The filters are placed in the scintillation vials under the fume hood with a drop of fuming HCl (37% or 6N) for 24 h to eliminate all the non-incorporated ^{14}C . Once they are dry 6 ml of Ecolume Scintillation cocktail are added. Following addition of scintillation liquid, the samples should be kept in dark for at least 3 hours to reduce chemiluminescence.

9) Scintillation counting:

- Radioactivity of the samples is determined by a liquid scintillation counter of beta particles at the University of Tromsø.
- The total carbon uptake is calculated from the equation:

Where

(a) = Sample activity (minus background), dpm

(b) = Total activity added to the sample (minus background), dpm

(c) = Total concentration of $^{12}\text{CO}_2$ in the sample water, $\mu\text{mol/L}$ (or μM)

(d) = The atomic weight of carbon

(e) = A correction for the effect of ^{14}C discrimination

k_1 = subsampling factor (e.g. sample 50 ml, subsample 10 ml:
 $k_1 = \text{subsample factor } 50/10 = 5$)

k_2 = time factor (e.g. incubation time 125 minutes: $k_2 = 60/125 = 0.48$)
The results will be given as $\mu\text{g C}\cdot\text{L}^{-1}\cdot\text{h}^{-1}$ per irradiance level.

10) Check of ^{14}DOC in the stock solution:

- at beginning and end of the cruise fill 50 μl of stock solution into scintillation vial.
- Add 0.5ml of 6N HCl and place under fume hood for 24 hours.
- Neutralize with 0.5ml of 6N NaOH.
- Add 15ml of Ecotone scintillation cocktail and keep vial in the dark until counting.

11) Calculation of total PP:

- Daily production rates from each depth are integrated to using trapezoidal integration. The rate nearest to the surface is assumed to be constant up to 0m depth. The difference of DIC uptake between the dark bottle and the dark bottle with nitrification inhibitor is the DIC uptake based on nitrification. The uptake of DIC in the bottle with nitrification inhibitor is assumed to be solely by anapleurotic heterotrophic processes.

7.27 DETERMINATION OF PRIMARY PRODUCTIVITY RATE IN RELATION TO LIGHT INTENSITY (P VS I CURVES) USING THE ^{14}C METHOD

Measured parameter: Primary production rate

Method responsible: Rolf Gradinger (UiT, rolf.gradinger@uit.no), Philipp Assmy (NPI, philipp.assmy@npolar.no)

Description of parameter: Determination of the production rate of organic material by phytoplankton under defined light intensities using the ^{14}C method.

Methodological description:

→ **Special requirements/gear:** radioisotope container, permission to work with radioactive isotopes, incubator onboard in cold room close to in situ temperature

→ **Sampling depth(s):** Subject to change depending on context, physical and biological in situ measurements temporary depths, 10, 20, 50, 60, 100, DCM and ca 2 m above sediment-water interface

→ **Chemicals used:** ^{14}C -sodium bicarbonate working solution (e.g. 20 $\mu\text{Ci/ml}$), Hydrochloric acid (HCl 6M and 1M), NaOH 6N, Ethanolamine

Material:

- Hydrobios ICES P vs I Incubator
- Incubation bottles with light screens
- GF/F filters
- Vacuum filtration manifold with waste bottles and vacuum pump and tubing
- Tweezers (2-3)
- Excicator with fuming HCl (37%)
- Micropipets and tips (One of each: 1000 μl , 200 μl and 20 μl)
- Cylinder (100 ml)
- Rinsing bottles (3x)
- Scintillation vials
- boxes to store scintillation vials for further processing back on land
- Trays for radioactive work
- Gloves (nitril size dependend on operator)
- Paper towels
- Radioactive waste containers (solid, liquid)
- Absorbing bench paper
- Light sensor
- Thermometer
- 2 glass duran bottles 0.5L
- ^{14}C -sodium bicarbonate working solution (e.g. 20 $\mu\text{Ci/ml}$)
- Hydrochloric acid (HCl 6M and 1M)
- NaOH 6N
- Ethanolamine

→ Assumption: DIC determined by other group, otherwise additional sampling needed.

→ **NOTE:** Always wear safety goggles, a lab coat and gloves when working with ^{14}C and any hazmat (e.g. scintillation cocktail). Collect all chemical/radioactive waste in clearly labeled waste containers. Keep a clear protocol on how ^{14}C has been used. This needs to be reported after the cruise.

Method (based on ICES Primary Productivity Protocol):

1) Placement of the incubator:

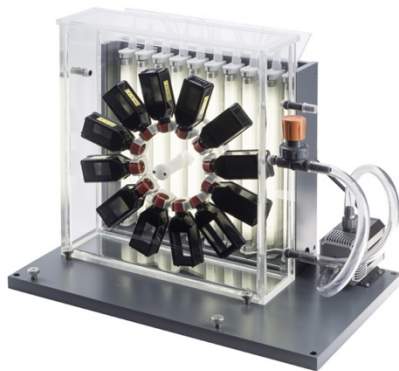

Fig. 7.27-1 HYDRO-BIOS ICES incubator (www.hydrobios.de)

- Place the incubator in a dark cold room (no additional light sources) close to in-situ temperature. Use 10 fluorescent tubes (will provide approximately a light intensity of $500\mu\text{E m}^{-2} \text{s}^{-1}$). Check with PAR sensor and note the correct 100% light value.

2) Preparation of flasks

- Use the provided 50ml culture tissue flasks. Rinse flasks between measurements with 10%HCl, followed by distilled water. Dry before re-use.
- Do a minimum of six different light intensities for a P vs I curve from one water depth or one ice core sample.

3) Selection of sample

- **Water sample:** take a water sample from either the chlorophyll a maximum (if present) or from the middle of the surface mixed layer (if no maximum present).
- **Ice sample:** take one complete ice core. Cut off and use only the bottom 1cm. Crush the ice (likely it will be in small pieces anyway if skeletal layer present). Place the sample into a clean 500ml duran bottle. Add 400ml filtered sea water at 0-2degC from the surface. Shake distribute the ice evenly and wait until it is melted. Use the melted sample as a water sample. Important: Note the final volume of the melted water sample to calculate the volume of the added ice sample. Take a sub sample for chl a and POC.
- **Melt pond sample:** if melt ponds are available on the ice, it should be treated like a water sample from the ocean.

4) Spiking with $\text{NaH}^{14}\text{CO}_3$ solution:

- Spike the entire volume of collected water with ^{14}C in a Duran glass bottle (e.g. if you use six light intensities plus one dark bottle you will need $7 \times 50 = 350\text{ml}$ spiked sample).
- Achieve a final concentration of $0.1\mu\text{Ci/ml}$ inside your incubation bottle. In case of low biomass in Arctic samples you can also use a final concentration of $0.4\mu\text{Ci/ml}$ (e.g. Ferland et al. 2011, <http://dx.doi.org/10.1016/j.jmarsys.2011.03.015>).
- Incubation bottles are filled with a measuring cylinder. The flasks should be filled up to the neck, leaving a small air bubble in the flask. One dark flask from each original sample should be incubated.
- All places on the incubator wheel must be taken by bottles. So empty spaces should be filled with bottles filled with DI water.

- 5) Determination of total labelled carbon added:
 - After mixing thoroughly 100 µl (x2) of the spiked solution are placed in two small scintillation vials and 6 ml of scintillation cocktail is added immediately if available.
 - in case direct counting is impossible the inorganic ^{14}C should be mixed with ethanolamine by pipetting 0.25 ml of sample with added activity together with 0.25 ml of ethanolamine.
 - 6ml of the scintillation cocktail can be added later and radioactivity determined in a scintillation counter.

- 6) Incubation
 - The incubation time should be two hours, and the rotor should rotate ca 10 rotations/min. Note precise incubations times (by minutes). Check proper functioning of the incubator, so that it does not stop – can be tricky....

- 7) Filtration: particulate and dissolved PP
 - After incubation the flask contents are filtered immediately. In case of high algal biomass or high sedimentation load it might be needed to filter a subsample. A defined portion should be taken and filtered.
 - Glass-fibre filters (GF/F, Ø 25 mm) should be used, To avoid any contamination of the filter edges, prewetted filters should be used. The suction pressure should not exceed 30 kPa during filtration. The filters should be rinsed once with a small volume (5 ml) of filtered seawater from the original sample (use filtrate of the chlorophyll-a measurement!).

- 8) DOC production samples
 - If DOC is going to be measured use the following sub-sampling from the spiked sample:
 - Filter 3ml of the incubation from each incubation bottle through a GF/F or 0.2 or 0.4 µm filter into a scintillation vial. You can use a Syringe filter for this. Add 500 µl of 6N HCl. Leave in the fume hood for 24 hours to release of $^{14}\text{CO}_2$. Neutralize the sample with addition of 500µl of 6N NaOH. Add 15ml of scintillation cocktail for immediate measurement in scintillation counter.

9) Post-Processing of particulate production filters:

- The filters are placed in the scintillation vials under the fume hood with a drop of fuming HCl (37% or 6N) for 24 h to eliminate all the non-incorporated ¹⁴C. Once they are dry 6 ml of Ecolume Scintillation cocktail are added. Following addition of scintillation liquid, the samples should be kept in dark for at least 3 hours to reduce chemiluminescence.

10) Scintillation counting:

- Radioactivity of the samples is determined by a liquid scintillation counter of beta particles at the University of Tromsø.
- The total carbon uptake is calculated from the equation:

$$dP/dt (\mu\text{g C}\cdot\text{L}^{-1}\cdot\text{hr}^{-1}) = \frac{\text{dpm (a)} \cdot \text{total}^{12}\text{CO}_2 \text{ (c)} \cdot 12 \text{ (d)} \cdot 1.05 \text{ (e)} \cdot k_1 \cdot k_2}{\text{dpm (b)}}$$

Where

(a) = Sample activity (minus background), dpm

(b) = Total activity added to the sample (minus background), dpm

(c) = Total concentration of ¹²CO₂ in the sample water, μmol/L (or μM).

(d) = The atomic weight of carbon

(e) = A correction for the effect of ¹⁴C discrimination.

k₁ = subsampling factor (e.g. sample 50 ml, subsample 10 ml:
k₁=subsample factor 50/10= 5)

k₂ = time factor (e.g. incubation time 125 minutes: k₂= 60/125= 0.48)

- The results will be given as μg C·L⁻¹·h⁻¹ per irradiance level and as well as the photosynthesis at light saturation (P_{max}), the maximum light utilization coefficient (a), and light saturation parameter E_k, from the P-E curve (see below for equation).

11) Check of ¹⁴DOC in the stock solution:

- at beginning and end of the cruise fill 50μl of stock solution into scintillation vial. Add 0.5ml of 6N HCl and place under fume hood for 24 hours. Neutralize

with 0.5ml of 6N NaOH. Add 15ml of Ecotone scintillation cocktail and keep vial in the dark until counting.

12) Calculation of PP:

- The carbon uptake ratios (y axis) are plotted against the light intensity received by each bottle (x axis). Fit the curve based on the equation of Platt and Gallegos (1980).

$$P = P_{\max} (1 - e^{-\alpha I / P_{\max}}) e^{(-\beta I / P_{\max})}$$

- Where P is the photosynthetic rate at irradiance I, α is the light-limited initial slope, β is a parameter describing the reduction in photosynthetic rate at high irradiance, and Pmax is a parameter equivalent to the light-saturated rate of photosynthesis when there is no photoinhibition.
- Manual for Marine Monitoring in the COMBINE Programme of HELCOM
- Part C: Annex C-5 Phytoplankton primary production
- Bouman et al. 2018: Earth Syst Sci Data 10: 251-266

7.28 MEASURING PHOTOSYNTHESIS USING PHYTO-PAM

Measured parameters: functioning of photosystem II

Method responsible: Natalie Summers (NTNU: natalie.summers@ntnu.no), Geir Johnsen (NTNU: geir.johnsen@ntnu.no)

Description of parameters: P vs I, ETR and Photosynthetic Yield at four different wavelengths

Methodological description:

→ **Special requirements/gear:** Vacuum Pump system next to sink and Phyto-PAM (Pulse Amplitude Modulated fluorometer) with the laptop in a dry area of the lab. Work area as dark and cold as possible.

→ **Sampling depths:** surface (5m) and Chl a max depth.

Method:

Keep everything in the dark and work in a dark room:

1. Surface water using CTD/rosette at three or five meters deep
 - Note depth and seawater temperature
 - Empty Niskin bottles into dark containers.
2. Concentrate sample if needed
 - When concentrations are below the detection limit of the Phyto-PAM.
 - 100x Volume concentration: from 300ml to 3ml.
 - Use a vacuum pump system but be gentle on samples. 5 seconds with the pump on followed by 10 seconds swirling with the pump off
 - Watch out when the volume gets below 25ml, filters fast
 - Do not let dry out or cells will die on the filter
3. Pour the 3mL sample into cuvette to analyse with Phyto-PAM
4. Setting up Phyto-PAM
 - Mount Optical unit (ED-101US/MP with standard 10x10 mm quartz-cuvette) onto the stand
 - Attach to the optical unit
 - Photomultiplier unit (PM-101P)
 - Measuring LED-Array-Cone (PHYTO-ML), for fluorescence excitation with blue (470 nm), green (520 nm), light red (645 nm) and dark red light (665 nm); with additional red LEDs (655 nm) for actinic illumination (up to 550 $\mu\text{E m}^{-2}\text{s}^{-1}$);
 - Photomultiplier-Detector (PM-101P) with filter box and special Detector-Filterset at a right angle to the Measuring LED-Array-Cone
 - Actinic LED-Array-Cone (PHYTO-AL) at 180° angle to Measuring LED-Array-Cone
 - Filters:
 - RG 9 has to be next to the photomultiplier,

- Special filter set (consists of a filter combination (in one frame) with 1 mm blue glass filter (BG3, Schott), 1 mm long-pass dichroic filter (R65, Balzers) and 2 mm long-pass red-glass filter (RG9, Schott)). The engraving "Cuv. Side" has to face towards the Perspex light-guide.
- Black anodised aluminium cover over the top
- Connect:
 - Power-and-Control unit:
 - Charger
 - PC
 - Photomultiplier tube
 - Actinic light array
 - Measuring light array
 - Temperature control unit:
 - Power
 - Peltier unit
- Laptop with Phyto-Win Software installed (Bio-optics 2 laptop)

7.29 PHYTOPLANKTON PIGMENT ANALYSIS (HPCL)

Measured parameters: Phytoplankton pigments

Method responsible: Natalie Summers (NTNU: natalie.summers@ntnu.no), Geir Johnsen (NTNU: geir.johnsen@ntnu.no)

Description of parameters: Pigment composition of phytoplankton samples for chemotaxonomy, pigment function, degradation status and photo-acclimation state. Samples will be analysed using a HPCL (High Pressure Liquid Chromatography)

Methodological description:

→ **Special requirements/gear:** Vacuum Pump system next to sink and Phyto-PAM with a laptop in a dry area. Work area as dark as possible. Store samples in a -80°C bio-freezer

→ **Sampling depths:** surface (5m) and Chl a max

Method:

Keep everything in the dark and work in a dark room

- Surface water using CTD/rosette at three or five meters deep
 - Note depth and seawater temperature
- Empty Niskin bottles into dark containers
- Insert 0.4 μ glass fibre Whatman filters onto the filter holder
- Shake water container five times
- Pour 1L or 2L at a time into a filtering bottle.
- Turn on the vacuum pump
 - Check nob on filtration manifold is in open position (vertical: open, horizontal: closed)
 - Make sure to secure the filtering containers with velcro
- Filter up to 3L of water using the vacuum pump
 - Start with 2L
 - Check the colour of the filter
 - Additional 1L if needed
 - Check time: don't filter for more than 20-30min
- When a few milliliters are left, turn the filter nob off
- Prepare a square of aluminium foil with a label
- Turn the filter nob back on until the filter dry
- Place the filter colour side up on aluminium
- Fold the filter. Make sure to use tweezers only on the edge of the filter where there is no colour
- Add a label and fold aluminium around the filter
- Label aluminium with a marker pen on the outside

→ **Storage:** Place in -80°C bio-freezer

7.30 PHYTOPLANKTON CELL SIZE AND HEALTH USING CYTO-SENSE

Measured parameters: Phytoplankton cell size and health

Method responsible: Natalie Summers (NTNU: natalie.summers@ntnu.no),
Geir Johnsen (NTNU: geir.johnsen@ntnu.no)

Methodological description:

→ **Special requirements/gear:** Vacuum Pump system next to sink and Phyto-PAM with a laptop in a dry area. Work area as dark as possible. Protective glove, a lab coat and safety goggles. Use of fume hood needed. Samples then kept in -80 C Bio-freezer

→ **Sampling depths:** surface (5m) and Chl a max

→ **Chemical:** Glutaraldehyde 25%, final concentration in fixed samples: 0.25%

Method:

Keep everything in the dark and work in a dark room

1. Surface water using CTD/rosette at three or five meters deep
 - Note depth and seawater temperature
 - Empty Niskin bottles into dark containers.
2. Concentrate sample if needed
 - When concentrations are below the detection limit of the Phyto-PAM.
 - 100x Volume concentration: from 450ml to 45ml.
 - Use the vacuum pump system but be gentle on samples. 5 seconds with the pump on and 10 seconds swirling with the pump off
 - Watch out when the volume gets below 25ml, filters fast
 - Do not let dry out or cells will die on the filter
 - Add 45 mL of seawater into a 50 mL centrifuge Falcon tube

- Cover tube in aluminium when transporting to fume hood (to keep samples in the dark)
- 3. In fume hood
 - add glutaraldehyde to a final concentration of 0.25% in the sample using the pipette
 - Dispose of the tip of the pipette in the appropriate bin (NON-HALOGENATED ORGANIC WASTE)
 - Close the centrifuge tube, seal it with a parafilm and cover in aluminium foil
 - After fixing the samples for 30 min, store samples in a -80°C freezer

→ **Storage:** After fixing the samples for 30 min, store samples in a -80°C freezer

7.31 WATER SAMPLING FOR BENTHIC EXPERIMENTS (NISKIN ROSETTE)

Measured parameter: Water sampling for benthic experiments chapter 10.3

Method responsible: Elisabeth Alve (elisabeth.alve@geo.uio.no) and Silvia Hess (silvia.hess@geo.uio.no), Paul Renaud (APN, per@akvaplan.niva.no), Lise Øvreås (UiB, lise.overas@uib.no), Arunima Sen (Nord, arunima.sen@nord.no)

Description of parameter: Water sampling for benthic experiments chapter 10.3

Methodological description:

→ **Special requirements/gear:** Niskin bottles on CTD

→ **Sampling depth(s):** Bottles need to be fired as close to the seafloor as possible in order to obtain bottom water

→ **Chemicals used:** none

Method:

- Approximately 100L of bottom water per station where respiration incubations will take place. Note: total volume need not be from a single deployment.
- Data needed: latitude / longitude, water depth.
- Bottles need to be fired as close to the seafloor as possible in order to obtain bottom water.
- Upon recovery to the ship, open bottles and use a funnel with a coffee filter to pour water into canisters.
- Keep canisters in the cold rooms in the dark where the respiration experiments will take place to get them to the temperatures that will be used for the experiments.
- The water will be used for filling up the cores used for the respiration experiments.

7.32 MICROBIAL/PARTICLES EXPERIMENTAL DESIGN

7.32.1 Grazer-exclusion experiment

Measured parameter: Abundance, activity and diversity of microorganisms (<0.8 μm ; <3 μm ; <90 μm)

Method responsible: Oliver Müller UiB (oliver.muller@uib.no); Lasse Mork Olsen (Lasse.Olsen@uib.no); Aud Larsen (aula@norceresearch.no); Gunnar Bratbak (Gunnar.Bratbak@uib.no)

Description of parameter/Aim: Surface water samples is gentle reverse filtrated to retain organisms of different size fractions (<0.8 μm ; <3 μm ; <90 μm) and are incubated for six days. Samples for abundance and diversity analysis are taken at different frequencies throughout the incubation period.

Methodological description:

→ **Special requirements/Gear:**

- Reverse filtration tubes, nylon filter mesh (<math><3\mu\text{m}</math>; <math><90\mu\text{m}</math>) and $0.8\mu\text{m}$ (142mm) polycarbonate membrane filters
- Set up experiments (filtration and filling bottles) in a cold room (301-chilled lab)
- Incubation in Termaks-incubator with close to *in-situ* light (ca. 30-50 $\mu\text{mol photons m}^{-2} \text{ s}^{-1}$) and at temperatures close to *in-situ* at the different stations (from 0-6°C)

→ **Sampling depths:** Process stations P1, P4 and PICE at chlorophyll a maximum (DCM or 20m)

→ **Chemicals used:** For sub-sampling as described in respective separate protocols ([7.20 Flow cytometry sampling](#); [7.21 Bacterial biomass production](#); [7.15 Light microscopy phytoplankton/protists](#))

Method:

NOTE: Since only trained personnel will conduct these experiments, the protocol provides only a shortened outline.

1. Preparations

- Make sure that all the bottles, reverse-filtration equipment and carboys have been acid-washed (5% HCL) and rinsed in Milli-Q water (3 times) and are labeled accordingly (e.g. "P1, <math><90\mu\text{m}</math>, A, 15.02.2020").

2. Sampling for the experiment

- Fill up each 20L in two carboys from the DCM at station P1, P4 and PICE and store the carboys cold until further processing when they cannot be processed at once.

3. Setting up the experiment

- Take the carboys with the water you sampled first and gently mix it and transfer it into the large HDPE bucket. Then use the plexi-tubes for reverse filtration with the $90\mu\text{m}$ net mounted to it (always start with the largest size fraction). Transfer 12L of the filtrate from inside the tube

into a new 20L container using silicone tubing and from there staggered fill 3+6 (including copepod addition) x 1L PC bottles (Fig. 7.27.1-1) controlled via an opening/closing system integrated to the tubing. The rest is stored cold until later to take samples for generating T0 data of different parameters as stated in Table 1.

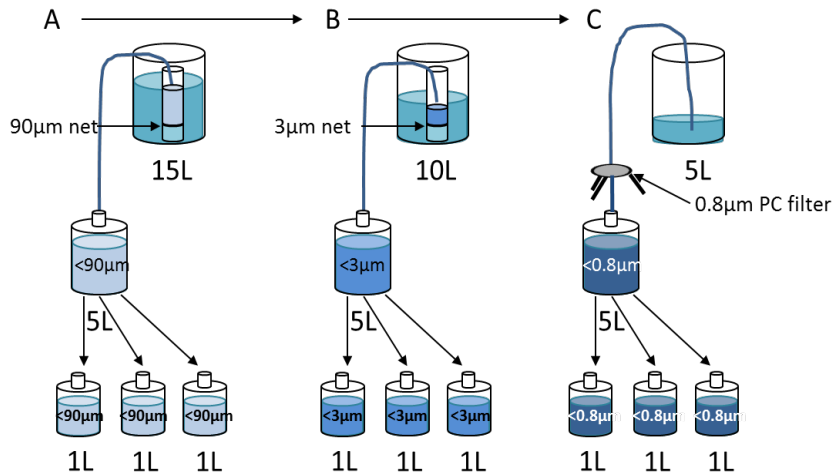

Figure 7.32.1-1 Schematic overview of the experimental set-up of the grazer-exclusion experiment and the reverse filtration procedure

- Repeat reverse filtration process, now with the 3µm net and after that with the 0.8µm polycarbonate filter via gravity flow through a tripod filtration device. For these two size fractions only each 3 1L bottles have to be filled and thus only 5L have to be filtered and transferred into a smaller 5L container. Now you should have filled 9 (15) x 1L PC bottles (3 for each size fraction and 2x3 extra for the copepod treatment of the <90µm fraction) and have 3 times 2L left which is stored to be processed later.
 - Transport all the bottles to the incubator where they will be incubated at close to *in-situ* conditions regarding temperature and light.
4. Taking sub-samples for different parameters at T0, throughout the incubation and at the end of the experiment (Important: different sampling frequencies for the different parameters)

Tab. 7.32.1-1 Overview of the parameters measured in course of the grazer exclusion experiment at different time points

Parameter	Protocol	Frequency	Volume	#Samples
FCM	7.18 [Flow cytometry sampling]	T0, T2, T3, T4, T6	6ml	T0: 21 2.: 102 (x5) T6: 102
Molecular sample	7.17 [Filtration for DNA samples using 0.22µm Durapore filters]	T0, T3, T6	T0: 1L T3: 200ml T6: 500ml	T0: 9 T3: 34 T6: 34
Bacterial production	7.19 [Bacterial biomass production]	T0, T3, T6	T0: 5ml T3: 5ml T6: 5ml	T0: 18 T3: 9 T6: 18
Flow-Cam/Microscope	7.13-14 [Light microscopy phytoplankton/protists]	T0 + T6	T0: 300ml T6: 100ml	T0: 9 T6: 10
Chl a	7.11 [Water sampling for chlorophyll a]	T0 + T6	T0: 300ml T6: 100ml	T0: 9 T6: 16
Macronutrients	7.10 [Inorganic nutrients]	T0 + T6	T0: 30ml T6: 30ml	T0: 9 T6: 16
TOC	7.5 [TOC]	T0 + T6	T0: 30ml T6: 30ml	T0: 9 T6: 16
POC	7.4 [POC]	T0 + T6	T0: 50ml T6: 50ml	T0: 9 T6: 16

→ **Sample storage/shipping address:** Samples that are taken during the experiment are stored according to the conditions stated in their respective protocols. The shipping address for all samples is:

Department of Biological sciences
 Att.: Oliver Müller/Gunnar Bratbak
 Thormøhlensgate 53A, 2. et.; 5006 Bergen
 Norway

7.32.2 Aggregation experiment

Measured parameter: Contribution of dissolved carbon pools to particle aggregation

Method responsible: Yasemin Bodur (UiT, yasemin.v.bodur@uit.no), Maria Guadalupe Digernes (NTNU, maria.g.digernes@ntnu.nu)

Description of parameter: contribution of dissolved carbon pools to particle aggregation and its seasonal variation

Methodological description:

→ **Special requirements/gear:** CTD Niskin bottles, roller tanks and roller table

→ **Sampling depth(s):** 30m

→ **Chemicals used:** acid detergent for pre-cleaning, HCl

Method:

- 15l will be carefully collected from the Niskin bottle and pooled in a canister
- 9l will be filtered through pre-combusted (4h at 450C) GF/F filters. The filters will be stored for POC analyses at -20C. After taking samples for DOC/C from the filtrate (3x 40ml), the filtrate will be filled in 3 pre-washed containers. Unfiltered water from the CTD will be incubated in 3 pre-washed containers for control treatments. All six tanks will be placed on a roller table at 3rpm and incubated at 4C in dark for ~24h.
- After the incubation time, the water from the tanks will be extracted and filtered through pre-combusted GF/F filters and samples for POC and DOC/C will be taken.
- For a detailed description of DOC/C sampling, see [chapter 7.6.1](#) in the sampling protocol

8 Short-time drifting Sediment traps

Measured parameter: Sinking particle flux

Method responsible: Marit Reigstad (UiT, marit.reigstad@uit.no), Miriam Marquardt (UiT, miriam.marquardt@uit.no), Yasemin Bodur (UiT, yasemin.v.bodur@uit.no)

Description of parameter: Water collection via sediment trap deployment. Water will be used for analysis of several parameters: Chla (size fractionated), POC/PON, phytoplankton, fecal pellets, stable isotopes, HPLC, IP25, particulate biogenic Silica (PBSi, DNA/RNA metabarcoding)

Methodological description:

- **Special requirements/gear:** Sediment trap type: KC-Denmark
- **Sampling depth(s):** 30, 40, 60, 90, 120 and 200m.
- **Chemicals used:** 4% GA-Lugol's Solution, buffered formalin (2%), Ethanol

Method:

- Duration of deployment ~24h
- Depths of the sediment trap cylinders are 30, 40, 60, 90, 120 and 200m.
- Deployment of 2 cylinders at 40, 90, 120m; 4 cylinders at 30, 60, 200m
- Cylinders are filled with pre-filtered deep seawater (GF/F filtrate, about 0.7µm pore size) prior to deployment

Processing of core parameters:

From each depth, Chla (size fractionated), POC/PON, stable isotope, phytoplankton and fecal pellet samples will be taken. Additionally, samples for IP25, HPLC, PBSi and stable isotopes will be taken at 30, 60 and 200m depth. Water from the trap is pooled before subsampling. The pooled sample needs to be thoroughly but carefully inverted before taking subsamples as the particles can sink down very quickly.

- **Chla** 100-500ml (light coloration) in triplicate
 - Total Chla is filtered onto GF/F filters, Chla > 10µm onto 10µm Polycarbonate filters. Otherwise the protocol for Chla samples will be followed.
- **POC/PON, stable isotopes** 100-500ml (light coloration) in triplicate onto pre-combusted GF/F filters, wrapped in pre-combusted aluminium foil, and stored at -20°C.
 - POC/PON and stable isotopes will be analyzed from the same filter simultaneously on an IRMS coupled to an elemental analyzer.
- **IP25** will be filtered in triplicate on a regular GF/F filter, wrapped in aluminium foil and stored at -20°C.
- **HPLC** will be filtered in triplicate on a regular GF/F filter, wrapped in aluminium foil and stored at -80°C.
- **PBSi** will be filtered on Polycarbonate filters, stored in capped, graduated polypropylene centrifuge tubes and frozen at -20°C.
- **Phytoplankton** 100ml fixed with 4% GLA-Lugol's Solution (2ml) and stored at 4°C in brown glass bottles.
- **Fecal pellets** 100-200ml fixed with buffered formalin (2% final concentration) and stored at 4°C in Kautex bottles.
- **DNA/RNA:** Approx 500-1000 ml from 30, 60 and 200 m will be filtered onto Sterivex filters for DNA/RNA metabarcoding according to [chapter 7.17](#).

9 Net sampling

9.1 PHYTOPLANKTON NET HAUL SAMPLING

Measured parameter: Qualitative collection of protists with a phytoplankton net

Method responsible: Rolf Gradinger (UiT, rolf.gradinger@uit.no), Philipp Assmy (NPI, philipp.assmy@npolar.no), Bente Edvardsen (UiO, bente.edvardsen@ibv.uio.no), Luka Supraha (UiO, luka.supraha@ibv.uio.no)

Description of parameter: Qualitative collection of protists for 1) documentation of live material on board by live microscopy and video/imaging, 2) collection of concentrated material for electron microscopy (TEM and SEM) analyses, 3) fixed samples for sharing with taxonomic specialists, and 4) establishing of protist cultures.

Methodological description:

→ **Special requirements/gear:**

- Phytoplankton net (10 µm mesh size) attached to a metallic frame onboard R/V Kronprins Haakon
- The crew will take the net haul on a winch. Agree with the crew on depth 50-0 m and speed 0.1 m/s on the way up.
- Fume hood for addition of fixatives.
- Waste container for gloves and tips

→ **Sampling depth(s):** Vertical net haul in upper 0- 50 m (or below the DCM if this is deeper than 50m) with a phytoplankton net onboard KH (see below).

→ **Chemicals used:** 20% hexamethylenetetramine-buffered formaldehyde (final concentration 2%), Lugol's (final concentration 1%), glutaraldehyde (EM grade 25%, final concentration of 1%)

Material:

- 3x 100 mL brown bottles
- 1x 15 mL centrifuge tube with screw lid

- 1x 50 mL Nalgene cell culturing bottle
- 1L plastic bottle with a wide opening
- 0.5L measuring cylinder
- Automatic pipette, 1 mL with tips
- Plastic pipette, 2 mL
- Gloves of nitrile
- 20% hexamethylenetetramine-buffered formaldehyde with data sheet
- 25% glutaraldehyde (EM grade) with data sheet
- Acidic Lugol's solution (10g KI, 5g J₂, 10 mL conc. acetic acid diluted to 100 mL with MQ)

Method:

1. Label three 100 mL brown glass bottles, one 15 mL plastic tube for fixed samples, and one clear 50 mL Nalgene cell culturing bottle for live sample with ID (if someone onboard will inspect the live sample, otherwise drop).
2. Attach the net on a wire run by the crew. Check that the canister is properly screwed in place.
3. Lower the net to 50 m depth (or 5-10 m below DCM) with the maximum speed 0.5 m/s, and retrieve with a slow and constant movement (0.1 m/s) back to above the water surface and deck.
4. Rinse the net very gently with a hose with seawater. Wait until the sample is below the top of the cod.
5. Open the cod with two screws. Pour the sample into a 1000 ml plastic bottle. Rinse the cod inside with filtered sea water from squeeze bottle. Remount the cod on the net and rins the net with fresh water from a hose.
6. Pour the sample into a 500 mL measuring cylinder. Distribute 90 mL into the 3 brown bottles, 14.4 mL into the tube and 50 mL into the clear bottle. Keep the samples cooled.
7. Under a fume hood and wearing gloves, add to brown bottle 1 and 2) 10 ml of 20% formaldehyde (2% final concentration), brown bottle 3) 1 mL Lugol's (1% final conc.) and to the 15 mL tube 600 μ L 25% glutaraldehyde (1 % final conc.). Use dispenser for the formaldehyde, a 2 mL plastic pipette for Lugol's and a 1 mL automatic pipette with tips for glutaraldehyde. Throw the used tip in a contained for risk garbage.
8. Store fixed samples dark and cold (see below), **do not freeze!**
9. For live samples: keep sample alive in cold room with plant light. Use the sample for microscopy, imaging, picking cells for monoalgal cultures and for single cell-PCR.

→ **Fixed samples storage/shipment address:** Store fixed samples in the formalin room (ca 10-15oC) during the cruise. Make sure that bottles are safely packed for transport (hard-casing boxes with bubble-foil filling). Brown bottles 1 are sent to NP (and then to IOPAS) and the rest is sent to UiO, IBV, AQUA.

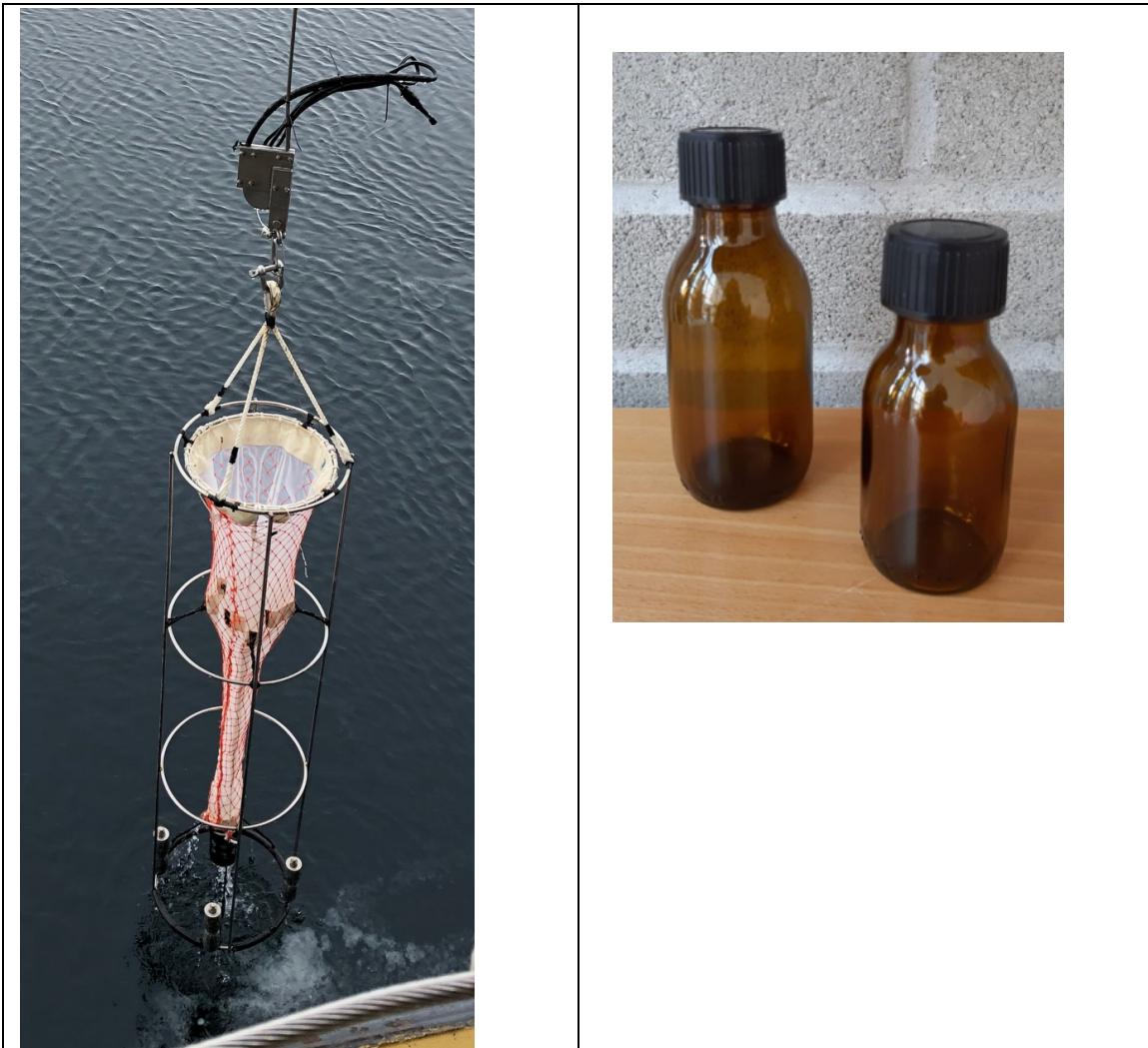

Fig. 9.1-1 Phytoplankton net from IMR net with steel frame (left hand side) and collection of brown glass sampling bottles (right hand side).

9.1.1 Microalgal diversity by culturing (capillary isolation)

Parameter definition: Capillary isolation of microalgal cells for culturing

Method responsible: Bente Edvardsen (UiO, bente.edvardsen@ibv.uio.no),
Luka Supraha (UiO, luka.supraha@ibv.uio.no)

Methodological description:

→ **Special requirements/gear:** Inverted microscope, cold room or cold plate, culture chamber or culture room with white illumination.

→ **Sampling depth(s):** Vertical phytoplankton net hauls (0-30m depths) from all sampling stations

→ **Chemicals used:**

Material:

- Pasteur pipettes that are heated and pulled out into a very thin tube (capillary), preferably with a 30° angle about 5-10 mm from the point. The diameter of the point should be 3-5 x the diameter of the cells to be isolated.
- Silicon tubing fitting to the wide end of the pipette and with a tube tip as a mouthpiece in the other end.
- Sterile Petri dishes in plastic or glass slides that must be clean.
- 50 mL tube with distilled water and 50 mL tube with algal medium
- Multiwell plates (96 wells, TPP, tissue culture testplate) with fitting lid, or glass tubes with screw lid, in rack, filled with algal medium.
- Inverted microscope with 4/5x, 10x, 20x and 40x objectives.
- Temperature control as far as possible: keep samples, petri dishes and solutions cooled on cooling elements or in a cooling box if sample is from a cold environment. If available use a microscope with a lamp with low heat emission (led).
- Plankton concentrated by net haul or a raw culture. Collect and keep the sample in a non-toxic bottle and avoid rapid changes in temperature or light shock during transportation and storage.
- The algal medium IMR 1/2 can be used for diatoms in coastal waters. For dinoflagellates and other flagellates that can be difficult to grow it may be worth to try other media such as ES- K- or L1-medium. Addition of soil extract

can help. It is important to avoid salinity shock. For isolation of species that thrive in oligotrophic waters the strength of the medium can, to start with, be reduced to 1/2-1/10 of the ordinary level. Dilute, if possible, the medium with sterile sea water from the actual locality.

Method:

1. Add 300 μ L suitable algal medium into each well of a 96 well plate. Add small droplets of medium in a row in a Petri dish (about 8) or on a glass slide (3). Add a droplet of the algal sample in the first droplet.
2. Fill some medium from a tube into the capillary by capillary-forces without sucking. By this it is easier to control the water movements in point 3.
3. Localize a cell under the microscope and pick up the cell (using 4 or 10x objective) with the capillary by gently sucking on the mouthpiece, together with as little medium and other cells as possible. Transfer the cell into the next sterile droplet of medium with a gentle blow.
4. Suck up distilled water into the capillary to kill other algae that stick to the pipette and blow it out again.
5. Repeat step 2-4 with the actual droplet, so that the cell is transferred to the next unused droplet and continue until the cell is seen alone in the next droplet, upon a quick look into the microscope.
6. Suck up the cell and transfer it to a well in the Multiwell plate with unused medium. Mark the used well and make a table with information about cell ID and origin.
7. When the desired cells are isolated place the plate in a clear plastic bag to avoid evaporation and place it for growth in a culture room or incubator with light and correct temperature.
8. Check the Multiwell plates in an inverted microscope (or a stereo microscope) after about 3-4 weeks depending on temperature and growth rate. From the wells with apparently uniform cultures a droplet is examined under the microscope at higher magnifications.
9. It is important to work fast to avoid heating and desiccation that will harm or kill the cell. It is better to take a chance and isolate many cells within a short time with the danger of including a "co-passenger" in some tubes, than to stress a few cells intensively to be safe that they are clean. You can also isolate several cells of the same species in one tube /well and let them start to grow,

and from this culture repeat the isolation to obtain a clonal culture (originating from one single cell).

→ **Samples storage/shipment address:** Multiwell plates containing serial dilutions should be kept in a culture room or an incubator with light/dark cycle at low temperature (4°C). During transportation put on a fitting lid and place in a cooling box with cooling elements and fill up with packing material to avoid tilting. Transported to University of Oslo.

Literature:

- Andersen, R.A. & Kawachi, M. 2005. Traditional microalgae isolation techniques. In: Andersen, R. A. (ed.). Algal Culturing Techniques. Elsevier Academic Press, 578 p.

9.1.2 Protist diversity by single cell PCR

Measured parameter: Isolation of protist cells for single cell PCR

Method responsible: Bente Edvardsen (UiO, bente.edvardsen@ibv.uio.no), Luka Supraha (UiO, luka.supraha@ibv.uio.no)

Description of parameter:

Methodological description:

→ **Special requirements/gear:** Inverted microscope, cold room or cold plate, freezer (-20°C or -80°C)

→ **Sampling depth(s):** Vertical net hauls from all sampling stations

→ **Chemicals used:** none

Material:

- Inverted microscope with objectives x4 or 5, x10, x20 and x40 magnification and x10 in the oculars with camera for photographing picked cells.
- Sterile plastic Petri dishes (10 cm diameter)
- Automatic pipette with sterile filter tips, 0.5-10µL

- Pasteur pipettes drawn out over a flame to a thin capillary with a ca 30 ° angle 1-2 cm from the tip. The diameter of the opening should be about 4-5 times the cell diameter.
- Silicon pipeline fitting to the wide end of the Pasteur pipette and a mouth piece (e.g. pipettetip) fitted in the other end.
- Sterile filtered sea water or algal medium in 50 mL tube in a rack
- Distilled water in a 50 mL tube (for cleaning capillary)
- PCR-water (Eppendorf) in 15 mL or Eppendorf tube
- 0.2 mL PCR- tubes in cooling rack
- Cooling blocks, x2 (to cool Petri dishes and racks with samples)
- Marking pen
- Diluted net haul sample (kept cool)

Method:

1. Pick cells by capillary isolation (see separate protocol).
2. For cells sticking to the bottom of a Petri dish, such as dinoflagellates: Transfer the cell into a droplet with sterile sea water (or medium) in a Petri dish. Remove most or all of the water (but not your dinoflagellate cell) in the first drop by a clean capillary (cleaned in sterile distilled water) and quickly add a new drop of sterile sea water on top of the cell (use a sterile pipette). Repeat this washing at least once with sterile sea water, or until no other cells are seen in the same droplet. Many dinoflagellates tend to stick to the bottom of the Petri dish and then this is the easiest way. If the cells do not stick to the bottom, e.g. planktonic diatoms or flagellated haptophytes or cryptophytes, transfer a single cell from one drop to another until you have only one cell in the droplet.
3. Prior to the last washing step, the cells are examined and photographed in an inverted light microscope at 200-400 x magnification.
4. Remove all water with capillary and add 10 µl of PCR-water to the cleaned cell with an automated pipette, and the cell and water is then transferred to a 0.2 µL PCR tube and frozen to -20°C. Mark the tube with a code and collect information about the sample (sample ID, species etc) in a table. The cells can be stored up to several months prior to the PCR-reaction.

→ **Samples storage/shipment address:** PCR tubes with isolated single cells must be kept frozen at -20°C prior to the PCR reaction.

Literature:

- Edvardsen et al. 2003. Genetic variability and molecular phylogeny of Dinophysis species (Dinophyceae) from Norwegian waters inferred from single cell analyses of rDNA. J. Phycol. 39: 395-408.

9.2 ZOOPLANKTON SAMPLING

Tab. 9.2-1 Overview of zooplankton sampling during Nansen Legacy cruises.

Gear	Depth	Haul	Station	Wire time (hrs)	No. depth	No. stations	No. samples	Taxa	Sample-type	Responsible
Multinet 64 µm	bott-200-100-50-20-0m	vertical	all P	1	5	7	35	Small mesozooplankton	Abundance	RF3: C. Svensen
Multinet 180 µm	bott-200-100-50-20-0m	vertical	all P	1	5	7	35	Mesozooplankton	Abundance	RF3: J. Søreide, A. Wold
								Gelatinous zooplankton	Abundance; Volume	RF3: J. Søreide, A. Wold
Multinet 64 µm	bott-200-100-50-20-0m	vertical	all P	1	5	7	35	Foraminifer & Pteropod		RF2: K. Zamelczyk
Bongonet 180 µm	bottom-0m	vertical	all P	1	1	7	7	Mesozooplankton	Metabarcoding	RF3: J. Søreide, K. Præbel
									Biomass	RF3: J. Søreide
Bongonet 64 µm	bottom-0m	vertical	all P	1	1	7	7	Small mesozooplankton	Metabarcoding	RF3: C. Svensen, K. Præbel
									Biomass	RF3: C. Svensen
Multinet 180 µm	bott-200-100-50-20-0m	vertical	P1, 4, 7	1	5	3	15	Mesozooplankton	Mortality	RF3: J. Søreide, K. Karlsson
									Respiration	RF3: J. Søreide, K. Karlsson
WP2 90 µm	70-0m	vertical	P1, 4, 7	1	1	3	3	Mesozooplankton	Experiments	RF3: C. Svensen
WP2 90 µm	70-0m	vertical	P1, 4, 7	1	1	3	3	Mesozooplankton	Experiments	RF3: A. Stippkugel, K. Karlsson
WP2/Bongo 180 µm	bottom-0m	vertical	P1, 4, 7	2	1	3	3	Mesozooplankton	Ecotox; SI; FA; HBI	RF2: K. Borgå, D. Kohlbach
MIK 1.5 mm	bottom-0m	vertical	P1, 4, 7	2	1	3	3	Macrozooplankton	Ecotox; SI; FA; HBI	RF2: K. Borgå; D. Kohlbach
MIK 1.5 mm	bottom-0m	vertical	all P	1.5	1	7	7	Macrozooplankton	Abundance	RF3: E. Bagøyen
									Biomass	RF3: E. Bagøyen
									Metabarcoding	RF3: E. Bagøyen, K. Præbel
Macrozooplankton trawl 3 mm	bottom-0m	v-haul	ad hoc	1.5	1	ad hoc	ad hoc	Macrozooplankton	Abundance; Biomass	RF3: E. Bagøyen

9.2.1 Mesozooplankton

Measured parameter: Mesozooplankton abundance, species composition, biomass dry weight (Multinet sample) and total biomass & genetic/metabarcoding (Bongo net sample)

Method responsible: Anette Wold, NPI (anette.wold@npolar.no), Janne Søreide, UNIS (janne.soreide@unis.no) and Camilla Svensen, UiT (camilla.svensen@uit.no)

Description of parameter/Aim: Provide information on mesozooplankton seasonal, annual and regional variations in abundance, biomass and species composition along a latitudinal environmental gradient in the Barents Sea from South to North.

9.2.1.1 *Mesozooplankton abundance/taxonomy*

Measured parameter: zooplankton abundance (ind/m³) and biomass (mg C/m³)

Method responsible: Anette Wold, NPI (anette.wold@npolar.no), Janne Søreide, UNIS (janne.soreide@unis.no)

Description of parameter: Provide information on mesozooplankton seasonal, annual and regional variations in abundance, biomass and species composition along a latitudinal environmental gradient in the Barents Sea from South to North.

Methodological description:

→ **Sampling depths Multinet 180 µ:**

- Bottom depth <600m (5 depths): bottom-200; 200-100; 100-50, 50-20 and 20-0 m
- Bottom depth >600m (5 depths): bottom-600; 600-200; 200-50; 50-20; 20-0 m

→ **Chemicals used:** 37% formaldehyde free from acid, 96% non-denatured EtOH

Material and Method:

- **Stations:** All process stations
- **Gear:** Multinet midi 180 µm mesh size (opening 0.25m²), see [Multinet manual section](#)

Sample treatment:

- The nets should be rinsed, and samples should be treated as gentle as possible throughout the process.
- Samples should be processed immediately after sampling.
- Larger gelatinous zooplankton should be removed prior to preservation, by use of plastic pipette or spoon with wholes, over a light table/ or white tray.
- Filter the rest of the content of the sample through a 180 µm sieve placed over a white tray in case something gets spilled.

- Move the samples from sieve into 125 ml bottle, fill the bottle to the neck with sea water
- Samples are preserved with Formaldehyde 37% (stabilised for histology free from acid).
- **Labels:** Use UUID labels including short human readable ID

9.2.1.2 *Small mesozooplankton abundance/taxonomy*

Measured parameter: zooplankton abundance (ind/m³) and biomass (mg C/m³)

Method responsible: Camilla Svensen, UiT (camilla.svensen@uit.no)

Description of parameter: Provide information on small mesozooplankton seasonal, annual and regional variations in abundance, biomass and species composition along a latitudinal environmental gradient in the Barents Sea from South to North.

Methodological description:

→ **Sampling depths:** (same as Multinet 180 µm)

- Bottom depth <600m (5 depths): bottom-200; 200-100; 100-50, 50-20 & 20-0 m
- Bottom depth >600m (5 depths): bottom-600; 600-200; 200-50; 50-20; 20-0 m

→ **Chemicals used:** 37% formaldehyde free from acid, 96% non-denatured EtOH

Material and Method:

- **Stations:** All process stations
- **Gear:** Multinet midi 64 µm mesh size (opening 0.25m²) → See [Multinet manual](#) for details
- **Sample treatment:** Same as for mesozooplankton abundance
- **Labels:** Use UUID labels including human readable ID

9.2.1.3 *Mesozooplankton mortality/activity*

Measured parameter: zooplankton abundance (ind/m³) and biomass (mg C/m³), zooplankton activity and percentage of dead zooplankton (non-consumable mortality)

Method responsible: Janne Søreide, UNIS (janne.soreide@unis.no), Anette Wold, NPI (anette.wold@npolar.no)

Description of parameter: Provide information on mesozooplankton non-consumptive mortality & respiration seasonally and regionally along a latitudinal environmental gradient in the Barents Sea from South to North. If time, mesozooplankton communities (known fraction of total sample) will be incubated to measure carbon utilization (respiration). After ended incubation, biomass of the community will be measured.

Methodological description:

→ **Sampling depths Multinet 180 µ:**

- Bottom depth <600m (5 depths): bottom-200; 200-100; 100-50, 50-20 and 20-0 m
- Bottom depth >600m (5 depths): bottom-600; 600-200; 200-50; 50-20; 20-0 m

→ **Chemicals used:** 37% formaldehyde free from acid, 96% non-denatured EtOH

Material and Method:

- **Stations:** P7, P5/P4 and P1
- **Gear:** Multinet midi 180 µm mesh size (opening 0.25m²), see [Multinet manual](#) section

Sample treatment:

- Samples should be processed immediately after sampling.
- The nets should be gently rinsed, and samples should be treated as gentle as possible throughout the process.
- Each sample (each depth) shall be divided in two by a Metoda plankton splitter. One part goes to non-consumptive mortality estimates (see

section A below) and the other part to incubations for measuring respiration (see section B below)

A. Non-consumptive mortality

- Gelatinous zooplankton should be removed prior to preservation, by use of soft tweezers or spoon with wholes. Note down in log book what is removed (species and size)
- Filter the rest of the content of the sample through a 180 μm sieve placed over a white tray in case something gets spilled.
- Move the samples from sieve into 125 ml bottle, fill the bottle to the neck with sea water and add 10 ml of red stain stock solution (for preparation see below) and let it stand for 20 minutes before the sample is preserved with Formaldehyde 37% (stabilised for histology free from acid) to a concentration of 4% (i.e. 12.5 ml per 100 ml sample volume).
- Store chilled and in the dark (must be analysed within 2-3 months)
- **Labels:** Use UUID labels including short human readable ID

Preparation of neutral red stock solution—Stock solution is prepared by adding 0.1 g neutral red powder (Neutral Red high purity biological stain; Acros Organics) to every 10 mL deionized water and slowly stirring the solution under dim light overnight to completely dissolve the powder. After preparation, the stock solution can be stored in the dark at room temperature in a sealed amber borosilicate glass vial. The exact shelf life of the stock solution was not tested, but we obtained good staining performance using a single stock for a month. It is therefore recommended that the stock solution be replaced monthly or after less than ideal storage conditions (e.g., excessive heat or light exposure).

B. Incubations - respiration

- Larger organisms of gelatinous zooplankton, krill and amphipods must be removed prior to incubations by use of soft tweezers or spoon with wholes.
- If dense sample divide it further with the Metoda plankton splitter and incubate these several parts of the same sample depth in separate bottles.
- Filter the sample-part gently through a 180 μm sieve placed over a white tray sub-ducted in sea water (to avoid organism to be damaged/ smashed).
- Move the sample from sieve into glass incubation bottles (Winkler bottles with glued on sensor spots), using GF/F filtered sea water, air bubbled for several hours, of ambient temperature and fill the bottle full and put on the cap (no bobbles should be present)
- Bottles are placed in a water bath at ambient temperature in the dark and is regularly (every hr) gently turned to keep the water well-mixed. For

information about the respiration equipment and how it functions see below.

- Read the O₂ concentration every hour, or even more frequently if they respire a lot until 80% of the initial oxygen concentration remain.
- After ending the measurements preserve the samples as described above with red stain and thereafter with 37% formaldehyde to 4% seawater-formaldehyde solution.
- Alternatively put the sample in pre-weighed aluminium dishes and freeze them for later analyses of dry weigh and CN in the lab on shore.
- **Labels:** Use UUID labels including short human readable ID

Respiration equipment / system:

For measuring the oxygen concentration in the incubated bottles sensor spots are glued on the inside of the glass bottles. By pointing an optode mounted to a 1-channel oxygen analyzer (©Loligo systems) to the spot the O₂ level can be measured. The instrument LEDs emits blue-green light that excites the oxygen mini sensor (optode) to emit fluorescence. If the oxygen sensitive dye encounters an oxygen molecule, the excess energy is transferred to the oxygen molecule in a non-radiative transfer, decreasing or quenching the fluorescence signal. The degree of quenching correlates to the partial pressure of oxygen inside the dye matrix, which is in dynamic equilibrium with oxygen in the sample. The decay time measurement is internally referenced.

9.2.1.4 Mesozooplankton genetics/ metabarcoding & biomass

Measured parameter: Molecular species diversity and relative abundance and biomass dry weight (mg/m³)

Method responsible: Metabarcoding, Kim Præbel, UiT (kim.præbel@uit.no); total biomass, Janne Søreide, UNIS (janne.soreide@unis.no)

Description of parameter: Provide information seasonal, annual and regional variations in biomass and genetic composition of the mesozooplankton fraction along a latitudinal environmental gradient in the Barents Sea from South to North.

Methodological description:

→ **Sampling depth:** Bottom-0 m

→ **Chemicals used:** non-denatured 96% EtOH

Material and Method:

- **Stations:** Standard stations & process stations
- **Gear:** Bongo-net, two nets of 180 µm (60 cm dia./0.2827m² opening)

Sample treatment:

- One net for metabarcoding and community - split sample in two.
- One net for biomass and overall food quality (fatty acid) - split sample in two.

For the metabarcoding & community net:

- Filter the content of the net through a 180 µm sieve placed over a white tray to remove as much water as possible (max. 300 ml). Put the sample into a plankton splitter (Motodo plankton splitter) to divide the sample in two equal parts.
- Part 1: Transfer the community part into a 125- or 250-ml bottle, fill the bottle to the neck with sea water and preserve the samples with Formaldehyde 37% (stabilised for histology free from acid). Final concentration 4% seawater-formaldehyde solution.
- Part 2: Use a sieve to remove as much water as possible for the metabarcoding sample. Transfer the organisms to a canister with as little seawater as possible and make sure the canister has space approx. 10x volumes of ice cold non-denatured 96% EtOH to the amount/volume of organisms. Place and store the canister at -20°C. After 24-48 hours, gently shake the canister, and change as much as possible of the EtOH with new ice cold EtOH.
- For the biomass & food quality net sample
- Sort out larger specimen such as krill and amphipods and treat the rest as one sample. Larger specimen should be measured individuals. Gelatinous zooplankton should also be picked out prior to preservation in the same manner as for the abundance samples.

- The biomass samples should be dried at 60°C for 24 hours and weighted and re-weighted in the laboratory at UNIS on a fine-balanced weight – the same used for weighing the aluminium dishes.
- Dried sampled should be stored and analysed for CN content back in the laboratory at UNIS.
- If the biomass samples are not dried and weighted it should be stored frozen (-20°C) until further processing.

Labels: Use Pre-printed Mesozooplankton genetics & Mesozooplankton biomass UUID labels

9.1.1.5 Small mesozooplankton genetics & biomass

Measured parameter: Molecular species diversity and relative abundance and biomass dry weight (mg/m³)

Method responsible: Metabarcoding, Kim Præbel, UiT (kim.præbel@uit.no); biomass, Camilla Svensen, UiT (camilla.svensen@uit.no).

Description of parameter: Provide information seasonal, annual and regional variations in biomass and genetic composition of the small mesozooplankton fraction along a latitudinal environmental gradient in the Barents Sea from South to North.

Methodological description:

→ **Sampling depth:** Bottom-0 m

→ **Chemicals used:** non-denatured 96% EtOH

Material and Method:

- **Stations:** Standard stations & process stations
- **Gear:** Bongo-net, two nets of 64 µm (60 cm dia./0.2827m² opening)

Sample treatment: Same as for mesozooplankton genetics & biomass

9.1.1.6 *Gelatinous zooplankton comments*

Measured parameter: Gelatinous zooplankton volume (ml/m³), abundance(inds/m³) & genetics.

Method responsible: Anette Wold (anette.wold@npolar.no) & Sanna Majaneva (sanna.majaneva@gmail.com)

Methodological description:

Gelatinous zooplankton should be taken from MIK net and either Bongonet or Multinett in order to cover all the size groups.

→ **Sampling depths:** (same as MIK net, Bongonet & Multinet)

→ **Chemicals used:** 96% non-denatured EtOH

Method/Sample treatment:

Gelatinous zooplankton should be removed prior to preservation

- keep the sample in a bit of water at all times in a white tray
- Be gentle when rinsing the samples
- Use wide mouthed pipettes or spoons to move the specimens from one container to another (do not pick them up with forceps or pour them from one container to another)

Features to consider when identifying ctenophores are:

- General size, shape and color
- Tentacles: length, location, tentacle bulbs, tentilla structures
- Comb row: lengths, length of individual cilia
- Radial canals
- See the «ID guide for pelagic Ctenophores in Norwegian Arctic” by Sanna Majaneva

What to record

- They should be identified to lowest taxonomic level possible, counted number of individuals and measure the volume for each taxon.

- Take a picture of each group of taxa including measuring tape or millimetre paper size reference.
- If time permits some individuals of each taxa group should be size measured (length and weight) and stored individually in Eppendorf, vials or falcon tubes in >96% non-denatured EtOH and stored at -20°C.
- Exchange as much of the EtOH as possible after 24-48 h

9.1.2 Macrozooplankton abundance, biomass & genetics

Measured parameter: Macrozooplankton abundance (ind/m³), biomass wet-weight (g/m³), and metabarcoding

Method responsible: Abundance & Biomass, Espen Bagøien, IMR (espen.bagoien@imr.no) & Metabarcoding, Kim Præbel, UiT (kim.præble@uit.no)

Description of parameter: Provide information on seasonal and regional variation in abundance, biomass and genetic composition of the macrozooplankton along a latitudinal environmental gradient from the Barents Sea into the Arctic Ocean

Methodological description:

- MIK net (Midwater Ring Trawl): use on all stations - both in open water and ice
- Macroplankton trawl: use *ad hoc* in ice-free water whenever time permits. A supplement to sampling with MIK - not a replacement.

→ Sampling depths:

For MIK: 1000m (or near bottom) to surface for MIK

For Makrozooplankton trawl: 700m (or near bottom) to surface

Material and Method:

Guide for MIK sampling - and processing of samples:

- Both in open waters and in ice: Haul MIK net vertically from near bottom - or from 1000 m when bottom-depth exceeds this depth - to surface (lowering speed: 0.3 m/s and hauling speed 1.5 m/s).

→ **Chemicals used:** 4% formaldehyde free of acid, 96% non-denatured EtOH

Sample treatment:

- Remove large gelatinous zooplankton (cnidarians, ctenophores) and fish, as well as other particularly large and few organisms, from the total sample. Place these removed organisms aside in the refrigerator or cold room (4°C).
- Weigh the remaining sample (total sample minus removed taxa) after removing excess water by use of sieve with mesh-size 0.5 mm.
- Mix the remaining sample gently to randomize the organisms
- Remove and weigh a sub-sample of < 100 g for metabarcoding (EtOH). Ensure that at least 3/4 of the sample from which the metabarcoding-subsample is taken is left for traditional, non-molecular analyses.
- **Metabarcoding subsample:** preserve the sample in approx. 10-times ice-cold (-20 °C) 96% non-denatured ethanol (EtOH) in 250, 500- or 1000-mL bottles. Store the sample at -20°C. After 24-48 hours, gently shake the bottle, and change the EtOH with new ice-cold EtOH.
- **Abundance/taxonomy sample:** Weigh and preserve the rest of the sample after the metabarcoding subsample was removed in seawater with final solution of 4% buffered formaldehyde in 250, 500- or 1000-mL bottles. To ensure a proper preservation of the organisms, their total volume should not exceed ca. ¼ of the bottle before adding sea-water and fixative.
- **Picked-out taxa:** The larger organisms that were previously removed from the total sample should now be identified to the lowest possible taxonomic level, length-measured, weighed (one collective weight per taxa) and photographed. Note the different procedure for gelatinous zooplankton & other taxa (described below). Freeze the length-measured and/or weighed groups of the removed taxa at -20 °C, each taxon in a separate plastic bag.

- **Gelatinous zooplankton:** Sort to lowest possible taxa, make length-measurements if time, and take pictures (to aid subsequent species identification/verification). Organize the pictures in digital folders according to stations. Remember to add a scalebar in the pictures (use white tray with measuring tape). Store individual specimen (up to 30 individuals of each taxa) in EtOH.
- **Registration of data:**
 - Register all data and metadata including UUID's in the Nansen Legacy sample-log
 - Register additional parameters such as:
 - weight of removed larger taxa (weight per taxa)
 - weight of remaining sample after removal of large individuals
 - weight of subsample for metabarcoding
 - weight of sample fixed with formaldehyde for abundance/taxonomy.
 in the "macrozooplankton journals and forms".
 - Register all data from the MIK trawl in the IMR Plankton database (latest version of "RegPlankton") either during the cruise or after the cruise. Keep the paper version in a journal.
- All samples and journals must be sent to IMR after the cruise.

Guide for Macroplankton-trawl sampling - and processing of samples:

- Comes in addition to the MIK sampling in ice-free waters whenever time permits.
 - V-hauls from Surface -> Maximum depth -> Surface
 - Sampling depth: Maximum of 700 m (or near bottom)
- **Chemicals used:** 4% formaldehyde free of acid, 96% non-denatured EtOH

Sample treatment:

- Almost same procedure as for MIK samples (see above).
- However, after removing large organisms such as jellyfish, fish, etc, from the total sample, three subsamples are collected from the remaining sample (described

below). If the sample is small, the whole sample can be preserved with formaldehyde instead of taking subsamples. Be sure to note weights of all removed organisms, the remaining sample after removals, as well as all subsamples to enable back-calculations representing the total sample.

- Collect and weigh one random subsample (< 100 g) for metabarcoding from the “mixed remains” after removal of large jellies, fish, etc – put in 10-times ice-cold (-20 °C) 96% non-denatured ethanol (EtOH) - see procedure for MIK above)
- Collect and weigh 2 random subsamples (for instance 200 grams each) from the mixed remaining sample (after removal of larger organisms). These 2 subsamples are dedicated to estimation of species composition and abundance. The first subsample is first weighed (without excess seawater), and thereafter preserved in seawater with final solution of 4% acid-free formaldehydes in a 1000 mL bottle. To ensure a proper preservation of the organisms, their total volume should not exceed more than ca. ¼ of the bottle before adding sea-water and fixative. The second subsample is just weighed (without excess sea-water) and frozen directly at -20 °C in a plastic bag – preferably flatly.
- Treatment of picked-out (removed) organisms, jellyfish, and registration of data follows the same procedure as for the MIK (described above).

9.1.3 Zooplankton acoustics EK80

Measured parameter: Zooplankton acoustics

Method responsible: Tom Van Engeland/Nils Olav Handagaard (IMR, tom.van.engeland@hi.no)

Description of parameter:

Methodological description:

GOALS

Map acoustic classes from ship mounted echo sounders and drop sonde over the diel cycle, the north-south gradient and seasonal components.

GENERAL

Two types of acoustic platforms are used during the cruise. The main instrument will be an EK80 echosounder with split-beam transducers registering at the frequencies at 18, 38, 70, 120, 200 and 333 kHz. This echosounder is mounted on the drop keel of the ship and cannot be operated under heavy sea ice conditions. Whenever unable to operate, its function will be taken over by a similar system mounted in arctic tanks in the hull. Considering the higher noise level in the latter because of the thick protective windows, the drop keel system is preferred. The decision on when to switch systems will be taken by the captain or bridge personnel. The second type of system consists of a probing setup in which the primary instrument is a sideways-looking EK80 echosounders operating at 4 frequencies.

DROP KEEL/ ARCTIC TANK SYSTEM

Setup

The echosounder systems on the drop keel and in the arctic tanks are Simrad EK80 systems with six split-beam transducers (18, 38, 70, 120, 200, and 333 kHz), that are mounted in such a way that their beam overlap is maximized along the vertical. Simultaneous current measurements will be made with an RDI 150 kHz ADCP, externally triggered by the echosounder as a master. A fixed time delay in transmission is implemented to prevent interference from the ADCP transmit pulse to the echo sounder data.

Echosounder calibration

Calibration is performed on the ship prior to the start of the cruise. Individual frequency channels are calibrated using appropriate tungsten carbide spheres.

Deployment

The drop keel system will work continuously throughout the campaign, but the backup system in the arctic tanks will take over its function, when ice conditions no longer warrant safe use of the drop keel (decided by bridge personnel/captain). The near-real-time data, that it provides, can be used to adjust net samplings if this is deemed interesting. The system will work in continuous wave (CW) mode at a ping rate of 200 milliseconds.

PROBE SYSTEM

Setup

The probe system consists of a steel frame that harbors an echo sounder system (EK80) with four split-beam transducers: (38, 70, 120, 200 kHz), that are mounted to “look” horizontally. In this configuration a larger part of the water column is scanned than in a vertically looking configuration. The probe can be equipped with a stereo-camera system that targets the water column within the acoustic beams.

Calibration

Calibration of the echosounder system is performed prior to the start of the cruise. Individual frequency channels are calibrated using appropriate tungsten carbide spheres. During this calibration the echosounder is mounted downward looking. After the calibration the transducers are re-installed in their sideways-looking configuration.

Deployment

TS probe casts are made at the process stations over 24-hour cycles, where applicable. This will enable an in-depth analysis of potentially occurring vertical migration behavior. In addition, the TS probe will be deployed on CTD stations in between the process stations whenever possible to increase the sampling density along the transect. On the down-cast, the probe is set to continuous wave mode (CW). During the down-cast, the probe is lowered at a constant velocity of 1 m/s in the dark. The down-cast will also be used to assess probe avoidance behavior by particular species. For this reason, no lights will be used on the down-cast. After the downcast, the probe will remain at depth (10 m above the bottom for safety, or max 1500 m depth) for 30 seconds with lights switched off. Subsequently, the echosounder is switched to frequency modulation mode (FM) and run at constant depth for 30 seconds before the up-cast is initiated. This will allow for longer assessment of avoidance behavior and additional information from the FM mode. At the start of the up-cast, lights (natural light) are switched on, and the probe ascends to the surface at 1 m/s. If the ship-borne acoustics (data available in real-time) show a pronounced scattering layer, the up-cast is interrupted to remain within the scattering layer for 30 seconds. This strategy is used for every substantial aggregation of scatterers that the probe encounters on its way up. In continuous wave mode (down-cast) the ping rate of the echosounder is set to 200 milliseconds. In FM

mode the pinging periodicity will be 300 ms. The ping range will be fixed at 50 meters in both modes.

The camera system will be used on the up-cast when light is available, and will provide information on the presence/absence (always) and size distribution (whenever in stereographic mode; not on Q4 cruise due to technical problem) of plankton/fish species.

DATA PROCESSING

Initial semi-automatic data processing of the echosounder data is performed by the Large Scale Survey System (LSSS, Korneliussen et al., 2006, 2016). This consists of noise removal (other acoustic instruments, trawl sensors, ship-induced, ...), signal alignment, imputation of missing data, automatic school detection and an automatic categorization, based on frequency response information in acoustic libraries and plankton inversion models (Korneliussen et al. 2016). Further interpretations will be made per standard procedures where the total backscatter will be split into target categories (see ICES, 2015; Korneliussen et al., 2016). Categories used for the Nansen Legacy will be: capelin, herring, polar cod, blue whiting, Norway pout, cod, haddock, redfish, saithe, O-group mixed, plankton mixed and other scatterers, in accordance with the protocol for acoustics during the ecosystem surveys. The scrutinized acoustic backscattering data in the echo sounder output will be in the form of the Nautical area scattering coefficient (NASC) in standard units; ($\text{m}^2 \text{nmi}^{-2}$, MacLennan et al. 2002). They will be integrated to 10-m depth bins relative to the sea surface, starting from about 15 m depth, depending on the draft of the transducers. The scrutinized data will be stored in accordance with standard procedures at IMR:

[//kvalitet.hi.no/docs/pub/dok03896.pdf](http://kvalitet.hi.no/docs/pub/dok03896.pdf):

Prosedyre for innsamling og bearbeiding av akustikkdata (Procedure for collection and treatment of acoustic data. Scrutinizing and storing the probe data to a local database will be made according to procedures under development.

All echosounder data and synthetic echograms will also be exported to a more common data format after initial processing, and combined with accessory data from CTD, ADCP, and zooplankton sampling. Further in-depth analyses will be performed in the R statistical software, Python and Matlab, and will

include non-supervised and supervised classification exercises, as well as correlative analyses with potential physical drivers.

Literature:

- ICES (2015). Manual for International Pelagic Surveys (IPS). Series of ICES Survey Protocols SISP 9 - IPS. 1–92.
- Korneliussen, R. J., Heggelund, Y., Macaulay, G. J., Patel, D., Johnsen, E., and Eliassen, I. K. (2016). Acoustic identification of marine species using a feature library. *Methods Oceanogr.* 17, 187–205. doi: 10.1016/j.mio.2016.09.002.
- Korneliussen, R. J., Ona, E., Eliassen, I., Heggelund, Y., Patel, R., Godø, O. R., Giertsen, C., et al. (2006). "The large scale survey system - LSSS," in Proceedings of the 29th Scandinavian Symposium on Physical Acoustics (Ustaoset).
- MacLennan, D. N., Fernandes, P. G., and Dalen, J. (2002). A consistent approach to definitions and symbols in fisheries acoustics. *ICES J. Mar. Sci.* 59, 365–369. doi: 10.1006/jmsc.2001.1158

9.1.4 Mesozooplankton & macrozooplankton for ecotox, stable isotopes & fatty acid samples

Measured parameter: Organic pollutants, stable isotopes, fatty acids, Hg, Carbohydrates, Proteins and Energetics (see section 13: Ecotoxicological samples)

Method responsible: Katrine Borgå (UiO, katrine.borga@ibv.uio.no)

Description of parameter: ([see section 13](#))

Methodological description:

→ **Sampling depths:** Samples will be collected from two distinct depth layers containing Atlantic & Arctic water masses. The depth will be decided depending on CTD profile.

→ **Chemicals used:** No chemicals used. All samples will be frozen

Material and Method:

- **Stations:** Process stations only
- **Gear:** WP3 1000 μm & MIK net
- **Sample treatment:** Samples will be sorted to species or higher taxa, see protocol for RF 2 regarding the amount needed for the different sample types and pay attention to avoid contamination

9.1.5 Stable isotopes, Fatty acids & Highly branched isoprenoids (HBIs)

Measured parameter: Stable isotopes, fatty acids & HBIs of POM and main zooplankton species

Method responsible: Philipp Assmy (NPI, philipp.assmy@npolar.no), Doreen Kohlbach (NPI, Doreen.kohlbach@npolar.no), Anette Wold (NPI, anette.wold@npolar.no)

Description of parameter:

Stable isotopes, fatty acids & HBIs of POM and the dominating zooplankton taxa will be used to study coupling/de-coupling of sympagic and pelagic primary and secondary producers. The relative abundances of sympagic and pelagic HBIs can be used to estimate the importance of sympagic carbon in the consumer's diet. For example, the HBI IP25 is known to be selectively produced by Arctic sea ice diatoms and can thus be used as a proxy for sea ice-associated diets. In addition, fatty acids (together with C/N ratios) will be used as a measure of food quality for the planktonic grazer communities and will be linked to on board grazing experiment. Water for POM-samples will be collected from chlorophyll maximum. We aim to samples all size categories from small mesozooplankton such as *Oithonia* spp. and *Pseudocalanus* to macrozooplankton such as krill, amphipods and gelatinous zooplankton.

Methodological description:

- **Special requirements:** The sampling will be done in collaboration with ecotox zooplankton sampling.
- **Sampling depths:** Zooplankton will be collected for Atlantic and Arctic water masses when separate layers are detected if no distinct water

masses zooplankton will be collected from the entire water column. The depth will be decided depending on CTD profile.

→ **Chemicals used:** 95 % Ethanol for rinsing (forceps, filtration equipment)

Material and Method:

Stations: Process stations only

Gear: Niskin bottle, ice corer, WP2 or Bongo Net 180 µm, MIK net 1500 µm

Sample treatment sea ice & watersamples:

Equipment sea ice and seawater sampling:

- Niskin bottles
- Ice corer 9 cm
- Stainless steel handsaw, cutting board, ruler for cutting ice cores
- Melting cups for ice cores
- 20 L containers for seawater samples
- 47 mm GF/F filters (pre-combusted: 6h, 500°C)
- Wheaton glass vials 8 mL (pre-combusted: 6h, 500°C)

Procedure seawater samples:

- Sample up to 24 L water from chlorophyll max (3 replicates for each parameter SI, HBI & FA)
- Fill the water into 20L containers

Procedure sea ice samples:

- Cut bottom 10 cm of the ice core with stainless steel handsaw
- Melt ice cores in container (cleaned with MilliQ) over a period of 24-36 h
- During period with little biological material pool several ice cores if possible.

Procedure filtration of sea ice and seawater samples:

- Filter the sample on pre-combusted 47 mm GF/F filters (6 h, 500°C)
- Duplicate or triplicate filters per sample plus one blank per filtration event
- Filtration volume: for sea ice typically between 150 and 500 mL, for seawater typically between 2 and 7 L. Filters need strong color (need approx. 50-60 ng of sample material)
- Filter manipulation only with ethanol-rinsed forceps
- Wrap filters in into pre-combusted 8 mL Wheaton glass vials (6 h, 500°C)

Sample treatment zooplankton

Equipment zooplankton sampling

- Forceps for handling organisms (ethanol-rinsed)
- Wheaton glass vials 8, 12, 16 or 25 mL (pre-combusted: 6h, 500°C)

Zooplankton, in-ice fauna:

- Zooplankton sampling is done together with zooplankton ecotox sampling by using WP2/Bongo net 180 µm to collect mesozooplankton and MIK net 1.5 mm for microzooplankton.
- Sample two depth layer per station, one in the Atlantic layer and one in the Arctic layer if there are distinct layers and if time permits. If time does not permit for sampling two layers aim for the most pronounced layer at that station.
- Pre-sort the sample by taking out larger specimen and gelatinous zooplankton. Dilute the sample in ambient sea water and keep the sample either in a cooler or cold room. Make sure the samples are diluted in ambient temperature sea water and not too dense.
- Take out sub samples and concentrate it gently before sorting it in the lab.
- Sort the samples to highest possible taxa under stereomicroscope for the smaller taxa and in white trays using head lamps for macrozooplankton. Use forceps, pipettes or spoons with holes. Make sure to keep the samples cold during sorting by use of cold packs or ice.
- Transfer the samples to Wheaton glass vials and store immediately at – 80 °C

- Sample size: small copepods: 15-30 individuals/sample & large amphipods: 1-2 individuals/sample
- Store the samples at -80°C until processing

Wear gloves at all time when manipulating sample material

9.1.6 Marine calcifiers (planktonic foraminifera and pteropods) abundance and their contribution to carbon flux

Measured parameter: zooplankton abundance (ind/m³) and carbon fluxes (mg C/m²d)

Method responsible: Griselda Anglada-Ortiz (Griselda.a.ortiz@uit.no) and Kasia Zamelczyk (kza002@post.uit.no)

Description of parameter: Provide information on planktic foraminifera and pteropods seasonal, annual and regional variations in abundance and species distribution along a latitudinal environmental gradient in the Barents Sea from South to North.

Methodological description:

→ **Sampling depths:** Multinet 63 µm: bottom-200; 200-100; 100-50, 50-20 and 20-0 m

→ **Chemicals used:** none

Material and Method:

- Stations: All process stations
- Gear: Multinet midi 63 µm mesh size (opening 0.25m²), see [Multinet manual](#) section

Sample treatment:

- The nets should be rinsed, and samples should be treated as gentle as possible throughout the process.
- Samples should be processed immediately after sampling: pick from the upper 150 m living foraminifera and pteropods (coloured cytoplasm), rinse them, transfer individually into Eppendorf's and freeze them at -80° C.

- Filter the rest of the sample through a 63 µm sieve to reduce the volume.
- Transfer the samples into 250 ml Whirl-Pak® *Nasco* plastic bags
- Samples are frozen at -20 °C or -80°C.
- Labels: Use UUID labels

9.2 ZOOPLANKTON EXPERIMENTAL DESIGN

9.2.1 Two-point dilution experiment

Instrument type: Plankton wheel for 2-liter bottles and WP-2 net (mesh size depends on target species)

Method responsible: tba (NTNU, tba) and Nicole Aberle-Malzahn (NTNU, nicole.aberle-malzahn@ntnu.no)

Description of parameter: Experiments will be used to determine phytoplankton growth and selective grazing of micro- and mesozooplankton on phytoplankton. Experimental water and hand-picked mesozooplankton will be used for analysis of several parameters: Chl a and other phaeopigments, POC/PON, fatty acids, dissolved and particulate nutrients (nitrate, phosphate and silicate), microscopic counting of phyto- and microzooplankton, flow cytometry of phytoplankton, bacteria and heterotrophic nanoflagellates (HNF)

Methodological description

- **Special requirements:** Incubation room with adjustable temperature to mimic in situ temperature, lab space in room with adjustable temperature to prepare seawater and organisms for experiments as well as for filtration work and microscopic hand-picking of mesozooplankton
- **Sampling depth:** DCM (5 m in case of no characteristic DCM) and 5 m at ice stations for phyto- and microzooplankton and 100 to 200 m for mesozooplankton

→ **Chemicals used:** neutral and acidic Lugol solution, 25% Glutaraldehyde, Methanol and 10% HCL (for cleaning)

Materials:

- Safety equipment (safety shoes, lab coat, goggles and gloves)
- Eventually polar suite for work in temperature regulated room
- Plankton wheel for 2-liter bottles
- Water pump to keep wheel in motion
- Acid-washed, non-cytotoxic bottles with a volume of 2 liters
- Thermometer
- 36 W luminescence tube
- Sieve with 180 μm mesh
- Funnel with silicon tube
- Buckets for water collection
- Filtration rack with vacuum pump, tubes and bottle for waste water
- GF/F filter (pre-combusted for POC/PON and fatty acids)
- 50 ml falcon tubes
- VacuCap 0.2 μm filter units with pressure bottles and acid-washed container to collect filtered seawater
- Tweezers
- Cryo vials, Eppendorf tubes and pre-combusted glass vials
- Light sensor
- Petri dishes
- Pipettes and tips (20 to 1000 μm)
- Nutrient medium
- Pasteur pipettes
- Brown bottles 200 ml
- Syringe filter 0.2 μm
- Syringes (10 and 50 ml)
- Tin capsules
- 96- well plates
- Tin foil
- Measuring vessels
- Anti-slide mats
- Stereomicroscope for mesozooplankton picking

Method:

(modification of Landry and Hassetts (1982) dilution series):

1) Placement of the plankton wheel:

- Place the plankton wheel in a room that is adjusted to in situ temperature of the sample depth
- Fill the plankton wheel with fresh- or seawater according to the water pump
- Adjust a thermometer inside the plankton wheel to monitor temperature
- Use external luminescence tubes as light sources according to seasonal condition and depth
- Shade the plankton wheel with e.g. black curtains of other light sources and disturbance

2) Seawater preparation:

- Collect with a CTD as much seawater (SW) as necessary from the desired depth
- Screen the SW with a 180 μm mesh to exclude mesozooplankton and transfer it according to the funnel-transfer technique in a separate bucket
- Store the SW in a room with *in situ* temperature and no light if further processing is delayed
- Filter as much SW as needed through a 0.2 μm filter to fill six 2-liter bottles with a 10% dilution (1 to 10 SW to filtered SW) as well as to have spare water to store mesozooplankton

3) Mesozooplankton sampling:

- Collect mesozooplankton vertically from 100 to 200 m upwards with a WP2 net (90 to 180 μm mesh)
- Put a plastic bag inside the bucket of the net to avoid distortion of delicate species
- Veer the net with less than 1 m s^{-1}
- Transfer content of bucket in bucket with filtered SW that was acclimatized to in situ temperature
- Store organisms in a room with *in situ* temperature and no light if further processing is delayed
- Take subsamples from bucket and either concentrate the sample through a 180 μm sieve and fill it in a petri dish with little water or divide

the subsample in smaller subsamples and use a tweezer or Pasteur pipette to catch desired mesozooplankton specimens

- Collect as many individuals as needed for each bottle in consideration of species-specific clearance rates
- Transfer hand-picked individuals in e.g. falcon tubes filled with filtered SW
- Store organisms in room with *in situ* temperature and no light if samples are not further processed immediately
- Pick some more individuals, clean them with Milli Q and transfer some of them in i) cryovials for preservation in liquid nitrogen for fatty acid analysis and other in ii) tin capsules, dry them for 24 hours at 60°C, roll the tin capsules up and store the samples in 96-well plates for CN analysis

4) Beginning of experiment - t_0 :

- Collect parameters mentioned above from the unfiltered SW (see other chapters for preparations of the different parameters)
- Samples for fatty acid analysis get solely sampled from t_0 SW and not from the experimental bottles at the end
- Mix enough 10% dilution (1 to 10 SW to filtered SW) to fill six 2-liter bottles and to collect the same parameters as for the unfiltered SW (except fatty acids)

5) Bottle preparation:

- Soak 2-liter bottles in 10% HCL for 24 hours and rinse them thoroughly with Milli Q or distilled water afterwards
- Record the volumes of the individual bottles
- Prepare 3 bottles with 10% diluted water mix, seal them bubble-free with parafilm and close the lit
- Prepare 3 bottles with 10% diluted water mix and add 1 ml of nutrient medium per liter as nutrient control, seal them bubble-free with parafilm and close the lit
- Prepare 3 bottles with unfiltered SW that was screened though 180 μ m mesh, seal them bubble-free with parafilm and close the lit
- Prepare 6 bottles with unfiltered SW that was screened though 180 μ m mesh, separate bottles in two different treatments with three bottles each, add one selected mesozooplankton species (e.g. *Oithona* sp.) according to species specific clearance rates in each bottle of one treatment and from another selected mesozooplankton species (e.g. *Calanus* sp.) in each bottle of the other treatment, seal them bubble-free with parafilm and close the lit

- Fill one bottle additional bottle with water to balance the wheel
 - Rotate bottles with not more than 1.5 rpm in the plankton wheel for 24 to 48 hours depending on the in-situ temperature
- 6) End of experiment – $t_{24(48)}$:
- Take bottles out of the plankton wheel
 - Filter same parameters as for t_0
 - Wash bottles in 10% HCL and rinse them with Milli Q or distilled water afterwards

→ **Sample storage/Shipments:** Samples are either stored dry at room temperature, at -20°C or -80°C or in liquid nitrogen, frozen samples need to be transported with dry ice or in a dry shipper, the samples are to be shipped to Angela Stippkugel, Trondhjem Biologisk Stasjon, Bynesveien 46 in 7018 Trondheim

Literature:

- Landry, M. R., & Hassett, R. (1982). Estimating the grazing impact of marine microzooplankton. *Marine biology*, 67(3), 283-288.
- Landry, M. R., Haas, L. W., & Fagerness, V. (1984). Dynamics of microbial plankton communities: experiments in Kaneohe Bay, Hawaii. *Marine Ecology Progress Series*, 16, 127.
- Morison, F., & Menden-Deuer, S. (2017). Doing more with less? Balancing sampling resolution and effort in measurements of protistan growth and grazing-rates. *Limnology and Oceanography: Methods*, 15(9), 794-809.
- Löder, M. G. J., Aberle, N., Klaas, C., Kraberg, A. C., & Wiltshire, K. H. (2010). Conserving original in situ diversity in microzooplankton grazing set-ups. *Marine Biodiversity Records*, 3.

9.2.2 Measurements of respiration of Calanus species

Measured parameter: Calanus respiration rates

Method responsible: Konrad Karlsson (UNIS, konrad.karlsson@unis.no)

Description of parameter/Aim: Respiration is an important estimate of biological activity and closely connected to the organisms' life history. This

experiment is aimed to measure respiration and the main factors that affect respiration on an individual level.

Methodological description:

→ Special requirements/gear:

→ Sampling depth(s):

→ Chemicals used:

Material (brief list):

- Cold room to store the samples
- 3 x 60 L buckets, 2 for samples, 1 for chlorophyll max water (CTD)
- Plastic pipettes, filters and small buckets for sorting zooplankton
- Incubator for experiments
- Computer with respiration software
- Microplate respiration system, wells with 500 and 1700 μL , the later for *C. hyperboreus*
- Filtration system to get GF/F filtered seawater
- Air pump with air stones to aerate water for experiments
- Tissue culture flasks 200 x 50 ml
- Microscope with camera + software + computer
- 5 x 96 well plates with pre-weighted tin cups
- NaSO_3 , for calibration of oxygen readers
- Silicone rubber compound, to fix loose oxygen sensors

Method:

Sampling

Copepods are sampled with a multinet to collect individuals from different depth (see chapter 9.3.1 Multinet manual).

The samples to keep for experiments are decided after the content is inspected, this will depend on the number of individuals at the different depths, to ensure there is enough material for experiments.

Two samples from different depths are placed individually in 60 L buckets filled with approximately 40 L sea water. The buckets are placed in a cold room with the temperature set to the prevailing water temperature; here the zooplankton is expected to be kept 3-4 days, until the next process station. Larger zooplankton such as jellyfish and appendicularians are removed to avoid fouling of the water.

Species and life stages are sorted from the samples, *Calanus finmarchicus* and *C. glacialis* for station P1 and P4; at station P7 *C. hyperboreus* will be used in addition. The experiments will be limited to the life stages C4, C5 and female C6, which stages that will be used has to be decided after the samples has been inspected. Priority will be on (1) the life stages and species that are the most abundant at the time and (2) present at as many depth fractions, stations, and seasons as possible.

Respiration is measured on a micro plate system that is placed in incubators at 0 °C. The plates have 24 wells that are filled with GF/F filtered water that has been aerated with air stones for approximately 24 hours at 0 °C, that is, the same temperature as the experiments are run at.

Copepods are added to 20 wells while 4 wells are left with experimental water only, in order to measure background respiration. Measurements are run for 3-4 hours, the copepods are then removed alive and placed in tissue culture flasks filled with water collected at chlorophyll max and screened through a 60 µm filter. The copepods are allowed to graze in the flasks for 24-48 hours; meanwhile the flasks are turned to disrupt settling of microorganisms.

At the end of the grazing experiment the complete content of the flask is poured out on a 20 µm filter from where the fecal pellets and the copepod are collected. The copepod is photographed under the microscope at a known magnification and pixel size and then placed in a tin-cup in a 96 well plate; these samples are later used for measurements on C/N ratio and dry weight. Pellets are counted and photographed at a known magnification and pixel size.

It is important to keep track of the individual in the experiments in order to link it to the data from respiration, grazing, morphology, and the 96 well plates. In addition to the data from experiments, information about species, life stage,

sampling site, and depth should be noted and linked to the individual. Aim for readings of 160 individuals at station P7 and 120 at station P1 and P4.

→ **Sample storage and processing of data:**

This experiment will only produce one type of physical sample, the 96 well plates. These should be stored at – 20 °C and later be analyzed for C/N ratio and dry weight.

The remaining data has to be stored in a way that it is possible to link it to the individual. In the final processed data file should have individual as a row and each parameter as a column. This may be challenging as the raw data produced during the cruise will be in different formats:

- The respiration software produce readings were each individual is a column and each row is a measurement in time.
- The morphology data will be pictures of each individual named after the specific well used during the respiration measurements (A1... A6, D1... D6).
- The fecal pellet production data will be added to an excel sheet with one column for the well, one column for the pellet count, and one column for the duration of the experiment (in hours). To the fecal pellet excel sheet, additional columns will be added: species, life stage, depth, station, and information about the individuals place in the 96 well plate.

→ Hence, for each plate reader, one file of respiration data is produced together with 20 pictures of copepods, 20 pictures of pellets, and one excel file with pellet production and the auxiliary data. These files will be generated for every respiration read and placed together in one folder, e.g. 8 folders for station P7 given 160 readings. Processing of data will be done after the cruise.

The shipping address for samples and equipment is:

Ship 96 well plates frozen at – 20 °C

The University Centre in Svalbard
Att.: Konrad Karlsson/Janne Søreide
Address: P.O. Box 156 N-9171 Longyearbyen

9.2.3 Experimental protocol for copepod egg incubations to determine secondary production and grazing experiment

Measured parameter: Secondary production and grazing rates of copepods

Method responsible: Christine Gawinski (UiT, christine.gawinski@uit.no)

Description of parameter/Aim: Mesozooplankton productivity will be determined experimentally for selected key copepod species through egg-production/egg-hatching incubations in different seasons, representing species with contrasting life-history traits and reproductive strategies in open and ice-covered waters.

Egg-production or egg-hatching incubations will be conducted seasonally to determine the egg production rate (number of eggs produced in 1 day) and the weight specific egg production rate (SEPR, defined as carbon mass of eggs produced over 24 h per carbon mass of female) of selected key species, such as *Oithona similis*, *Microcalanus sp.*, *Calanus finmarchicus*, *C. glacialis* and *C. hyperboreus* during different seasons along the transect.

The SEPR can subsequently be used to estimate the copepod production, assuming that female copepods allocate their ingested carbon into egg production rather than into growth. Because SEPR is assumed to equal the growth rate of younger stages, total production can be calculated from the SEPR and the standing stock (Kiørboe und Sabatini 1994).

Data from on-board grazing experiments and fatty acids and stable isotope samples will be used to determine food quantity and quality of selected copepod grazers throughout the seasons and how it relates to secondary production.

Methodological description:

→ Special requirements/gear:

→ Sampling depth(s):

- Bottom depth < 600 m: bottom – 200 m, 200 – 100 m, 100 – 50 m, 50 – 20 m, 20 m – surface

- Bottom depth > 600 m: bottom – 600 m, 600 – 200 m, 200 – 50 m, 50 – 20 m, 20 m – surface

→ **Chemicals used:**

Method:

To determine *mesozooplankton community composition*, samples will be taken with a Multinet Midi (5 nets, 64 µm mesh size, 0.25 m² opening, Hydrobios Kiel, Germany) at all process stations in the following depth intervals:

- Bottom depth < 600 m: bottom – 200 m, 200 – 100 m, 100 – 50 m, 50 – 20 m, 20 m – surface
- Bottom depth > 600 m: bottom – 600 m, 600 – 200 m, 200 – 50 m, 50 – 20 m, 20 m – surface

Samples will be preserved in 4 % buffered formaldehyde (final concentration) immediately after collection and analysed at the collaborative institute IOPAN – Institute of Oceanology, Polish Academy of Sciences, Poland.

Live copepods for the egg incubations will be caught with a non-filtering 64 µm meshed WP2 net in surface waters (70 – 0 m) at three process stations, namely P1 (reference station for Atlantic water communities), P4 (mix of Atlantic and Arctic water masses) and P7 (sea ice station).

To reduce water pressure and a consequent harm of the copepods during trawling, a large plastic bag will be inserted into the cod end before each haul (non-filtering cod end). After the catch is on deck, the WP2 net will not be washed, because this might cause injuries and stress to the copepods. A bucket that has previously been filled with a small amount of sea water, will be placed under the cod end. The cod end will be opened carefully (as water might spill over) and the content of the cod end will cautiously be transferred into the bucket. If immediate processing of the copepods after sampling is not possible, the copepods will be stored in a cold room and oxygen will be provided via an Aqua pump.

To determine the *sex ratio, the female/egg-ratio and the developmental stages* of the copepods, an additional haul with a 50 µm meshed WP2 net will be performed from 100 – 0 m. Females with eggs will be counted on board and the rest of the

sample will be fixed in 4 % buffered formaldehyde (final concentration) for analysis back at UiT.

Egg incubation experiments:

Egg-carrying copepods – incubation method (egg-hatching)

During the egg-hatching incubations, 30 egg-carrying females of a selected sac-spawning copepod species will be incubated per station, using the *in situ* water temperature at the chlorophyll *a* maximum found at the station (possibly in a range of: P1 Atlantic: 3 – 6 °C, P4 mixed: 2 – 4 °C, PICE Arctic: < 0 – 2 °C).

Copepods will be identified and picked in a cold room under a stereomicroscope, with the temperature of the cold room being in the range of the temperatures found in the upper surface waters at each of the stations. After reverse filtration of the content of the bucket, a small amount of the copepods will be transferred into an evaporation dish. From there, copepods will be picked with a pipette and put into a separate evaporation dish filled with filtered sea water (same temperature as experimental temperature). Females with egg-sacks will be placed individually into 2.5 ml of 0.2 µm FSW, in 12-well culture plates. Each well will be checked individually for contamination with e.g. nauplii. The plates will be transferred in a cooling box from the cold room to the hangar, where they will be incubated in temperature-controlled incubators.

In total, six 12-well plates will be used, as only 5 wells of each plate will be filled with a copepod, to decrease handling time of each plate during the hatching controls. A temperature logger (HOBO logger) will be placed in a bowl with sea water and temperature will be logged every five minutes for the duration of the experiment. The plates will be placed next to each other in the incubator.

Each of the plates and wells will be labelled with a unique number and the clutch size of each individual copepod will be recorded during the first two days (total eggs carried in the egg sacks of a female will be defined as a clutch. During each of the hatching controls, the clutch size of all females of one plate will be counted visually under the stereomicroscope. Note: all clutches have to be counted in the first two days, because it has been observed that eggs can dissolve after 5 days). Depending on the incubation temperature and capacity, the wells will be checked

every 12 h for hatching (24 h checks up to 3 °C, 12 h checks up to 5 – 6 °C, 8 h checks > 6 °C if possible). To keep the experimental conditions as stable as possible and to decrease the handling time in the cold room (should be less than 10 minutes), only one plate at a time will be examined. The exact date and time of the hatching event (time when the first nauplius of the clutch was seen moving freely) and the number of newly hatched nauplii for each interval will be recorded. Nauplii will be removed after counting and can be stored in a labelled tube filled with 4 % formalin (buffered) if needed.

The water will be mixed with 8 gentle strokes after checking for nauplii. Every second day ca. 50 % of the water will be replaced with FSW. Wells containing dead females during the first 24 h of the experiment will be excluded from the data set. During the first two days all females will be photographed using a camera connected to a stereomicroscope for prosome length. The experiment will be run as long as possible and terminated after at least 50 % of the eggs have hatched (however, 50 % might not be reached at lowest temperatures due to time constraints). All unhatched eggs will be counted, and the copepods will be stored in labelled tubes filled with 4 % formalin (buffered), if needed.

The EPR (eggs female⁻¹ d⁻¹) from the incubation experiments can be calculated as follows:

$$EPR = \frac{E}{I \times F}$$

Where E is the total number of eggs produced, I is the incubation period in days and F is the number of females incubated (Harris et al. 2000).

Broadcast spawning copepods – egg production/direct observation method

To determine the egg production rate of broadcast spawning copepods, 30 adult females without eggs of a selected broadcast-spawning copepod species will be incubated separately for 24 h or 48 h at in situ temperatures in a spawning chamber equipped with a screened partition that allows the eggs to sink away from the female. After the incubation time, the produced eggs will be counted. To evaluate hatching success, the produced eggs will be incubated and checked every 12 h for hatching. Date and time of each hatching event will be recorded.

The egg production rate can be calculated as follows:

$$EPR = \frac{E}{I \times F}$$

Where E is the total number of eggs produced (estimated after 24h or 48h of incubation), I is the incubation period in days and F is the number of females incubated (Harris et al. 2000).

Estimation of secondary production

Growth rate is assumed to be exponential, in which case the secondary production can be calculated as:

$$PR = \sum [G_i B_i] + G_f B_f$$

Where G_i and G_f are the weight specific growth rates (d^{-1}) of stage i and egg production rate of females, respectively, and B is the biomass ($B_i = N_i W_i$) (Harris et al. 2000).

Carbon content analyses:

In addition to the 30 copepods picked for the egg-hatching experiments, 60 – 100 females of the same species will be picked per station for carbon content analysis (minimum value detected by the instrument is 5 μ g C and 1 μ g N, therefore 60 – 100 individuals are needed for one filter, aim for 100).

For sac-spawning copepods the egg sacks of each female will be removed carefully and placed into a petri dish. After that, the females will be transferred into an evaporation dish with FSW. If there is a lot of algae in the water, this procedure might be repeated twice, to rinse the animals. It is important to count the animals accurately. Then, as much of the FSW as possible will be removed from the evaporation dish (making sure to not remove animals, so a stereoscope will be used). A pre-burned GF/F filter will be placed on the filtration rack, without using the cup that holds the water (the plastic cup that is put on top of the filter). The filter will be moistened with milli-q water and the pump will be turned on. Gently, using a glass Pasteur pipette, the water with the copepods will be transferred drop

by drop onto the filter, making sure not to spill anything off the sides of the filter. The pump will be running during the whole procedure. The evaporation dish will be rinsed with FSW, to make sure all copepods are transferred. In the end, 1 ml of milli-q water will be used to wash away salt from the filter with the copepods. The filter will be folded once, wrapped in aluminium foil, labelled, placed in a small zip lock bag and stored frozen at -20 °C (note how many females on the filter).

The same procedure will be conducted for 50 egg sacks. Based on the average number of eggs per egg sack, the number of egg sacks needed for the carbon content analysis will be determined (based on the assumption that one egg has a carbon content of around 14 nanogram C and one egg sack has an average number of 15 eggs, around 25 egg sacks would be needed to reach the minimum detection limit of the instrument, personal communication Barth-Jensen, to be on the safe side, 50 egg sacks will be used).

The carbon content analyses of the females and egg sacks will be done in two replicates.

Clutch and egg sizes:

The number of eggs of a total of 30 egg sacks will be counted and the sizes of 50 eggs (5 eggs per egg sack) will be measured (via stereomicroscope photo. With the boat vibrations, taking a picture and measuring after is more effective and measurements can be delayed, if other things have to be done at the moment. The data will be backed up on a USB stick).

Fatty acid and stable isotope samples:

For each fatty acids and stable isotope analyses, 50 individuals of each experimental copepod species will be placed in a cryotube, labelled according to the Nansen-Legacy labelling protocol and immediately frozen at -80 °C. Three replicates will be conducted for both fatty acids and stable isotopes.

General things:

5 – 10 l incubation water from each process-station will be taken from the CTD-rosette and will be filter through a 0.2 µm filter in the cold room. Afterwards, it will

be put in the incubator, which will be set to a proxy of the surface temperature that can be expected at the next station. After the CTD cast at the station has been performed, the incubator will be set to the correct temperature. A bottle of FSW of the station will be kept in the incubator during the duration of the experiment, which will be used for water exchange in the incubation wells. Before putting female copepods into the water, the water temperature has to be checked and should be close to the incubation temperature ($\pm 1.5\text{C}$ max). To accelerate the cooling process, the FSW can be put in a small dish (cover the dish, as dust might fall into it), so that the volume to cool is smaller and therefore will cool down faster.

The incubator has to be started well in advance before the first station, as it could take about 4 hours to cool down from 20°C to 2°C .

Grazing experiment

On-board grazing experiments will be conducted in collaboration with the research group 'Marine microbiology' of the University of Bergen, to determine food web interactions on a spatial and temporal scale. The microbiology group is conducting different grazer exclusion experiments with $0.8\ \mu\text{m}$ screened (Prokaryotes only), $3\ \mu\text{m}$ screened (Prokaryotes + heterotrophic nanoflagellates (HNF)) and $90\ \mu\text{m}$ screened sea water (Prokaryotes + HNF + Ciliates + Diatoms). During this collaboration two additional zooplankton treatments, one with 20 *Oithona similis* and one with 3 *Calanus sp.*, each in three replicates, will be added to their setup. The data will be analysed by the microbiology group in Bergen.

Literature

- Harris, Roger; Wiebe, Peter; Lenz, Jurgen; Skjoldal, Hein-Rune; Huntley, Mark (2000): ICES zooplankton methodology manual: Elsevier.
- Kjørboe, Thomas; Sabatini, Marina (1994): Reproductive and life cycle strategies in egg-carrying cyclopoid and free-spawning calanoid copepods. In: *Journal of Plankton Research* 16 (10), S. 1353–1366.

9.2.4 Calanus exposure experiment

Measured parameter: Global transcriptome analysis of different Calanus species in response to oil contaminants.

Method responsible: Fekadu Yadetie (UiB, fekadu.yadetie@uib.no)

Parameter description: Calanus are harvested during the zooplankton sampling and species as well as stage of development determined. Calanus are then exposed for three days at their ambient temperature to oil contaminants such as benzopyrene, phenanthrene, or the water fraction of raw oil. The transcriptional response is determined in the laboratories at UiB and compared across species.

Species

- Calanus hyperboreus, stage CV
- Calanus finmarchicus, stage CV
- Calanus glacialis, stage CV

Sampling protocol

- See Mesozooplankton sampling

Material:

- 500 mL measuring cylinder
- Tape for labelling
- Marker pen
- 500 mL glass bottles
- BaP and Phenanthrene stock solutions
- DMSO
- Pipette & Pipette tips
- Filtered sea water (0.7 µm)
- Plastic Pasteur pipettes
- Dishes and beakers for sorting
- Fridge for incubations (in chemical room for 3.5 °C and other incubator for 1-2 °C)

- Cryotubes
- Liquid N₂
- A small liquid N₂ container
- Containers for hazardous liquid and solid waste

Method:

All work with chemicals has to be performed in a laminar flow hood/fume hood and hazardous waste has to be treated according to the standard waste treatment protocol of the host university.

- Fill glass bottles with 500 mL filtered sea water
- Work on ice
- Add 10 specimens of *Calanus hyperboreus*, 10 specimens of *Calanus glacialis*, or 20 specimens of *Calanus finmarchicus* per bottle using a plastic Pasteur pipette
- Preferably 5 replicates per exposure group
- After all specimens are added, add chemical to bottles
- Incubate for 72h @ 3.5 °C (fridge in chemical room; *C. hyperboreus* and *C. finmarchicus*) or @ 1-2 °C (*C. glacialis*) – or use ambient temperature
- Check every 24h and note immobile specimens (dead *Calanus* appear whitish) without opening the bottle
- Collections:
 - Harvest only alive *Calanus* with a 180 µm filter (water into waste container)
 - *Calanus* in small petri dish with filtered sea water
 - Transfer *Calanus* to cryotube
 - Remove excess liquid using a 1 mL pipette
 - Snap freeze in liquid nitrogen and store at -80 °C
 - Snap freeze in liquid nitrogen and store at -80 °C

Concentrations used on August cruise 2019

BaP exposure concentration	0.1 µM
BaP stock solutions (in DMSO)	0.5 mM
Amount of stock to be added to 500 mL	100 µL

Phenanthrene concentration	exposure	0.1 μ M
Phenanthrene stock solutions (in DMSO)		0.5 mM
Amount of stock to be added to 500 mL		100 μ L

Notes for 2020:

- The protocol can be modified to try different exposure conditions.
- Correct staging and species identification are critical.
- Stock solutions of the exposure chemicals (e.g. BaP and Phe) should be prepared before going onboard.
- For RNA extraction snap-freezing of the samples in liquid N2 (and storing at at -80 °C) gives best results. RNAlater can be used as alternative, if liquid N2 is not available. Samples should be transported in a dry shipper or in dry ice packages.

9.3 ZOOPLANKTON MANUALS

Tab. 9.3-1 Overview table of hauling speed for the different nets

Net & mesh size	Lowering speed	Hauling speed	Ship speed
Multinet 180 μ m	0.5 m/s	0.5 m/s	n.a.
Multinet 64 μ m	0.5 m/s	0.3 m/s	n.a.
Bongonet/WP2 180 μ m	0.5 m/s	0.5 m/s	n.a.
Bongonet/WP2 64 μ m	0.5 m/s	0.3 m/s	n.a.
MIK net 1500 μ m vertical	0.3 m/s	1.5 m/s	n.a.
MIK net 1500 μ m V-haul	0.4 m/s	0.25 m/s	Ship speed during hauling 3 knot

9.3.1 Multinet manual

Specification: Opening 50cm*50 cm = 0.25m², size of box: 80 cm*90 cm*95 cm, 5 net bags 250 cm long with mesh size of 180 µm & 64 µm, overall length 560 cm.

Introduction: The Multinet is deployed with all net bags closed and the water flowing freely through the frame. The instrument can be lowered with high speed to the greatest desired depth. It can either be operated by use of communication cable and deck unit and nets can be opened manually or it can be used off-line by pre-programming it as described below. All measuring data are stored inside the internal data memory during the operation and can be read out by a PC when the Multinet is back on board.

Hauling speed of different net types:

Multinet 180 µm: lowering 0.5m/s and heaving 0.5 m/s

Multinet 64 µm: lowering 0.5m/s and heaving 0.3 m/s

Off-line preparation of Multinet: Check that the small pin on the rotating cylinder is in the right position (if not see instructions below).



Fig. 9.3.1-1 There is a small pin on the rotating cylinder which should point straight at the pin seen here.

1. Turn on the Multinet
2. Connect Multinet to the Toughbook, open program "OceanLab3" from desktop.
3. Check the battery (3* Lithium 123A/ 3V status), should be >7.
4. Connect to Multinet using *connect symbol* (1st from left in menu bar)
5. Open the *control mode* (6th from left in menu bar)

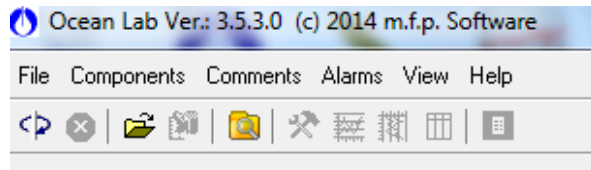

Fig. 9.3.1-2 Menu bar of the Ocean Lab software

6. Choose *Pressure programming* to program the releasing depth. Remember that the Unlock depth must be minimum 1 m below the depth of the 1st net. The nets do not open if the Multinet has not been set below the unlock depth. Always go at least 5 m below to make sure it opens (if not the cast needs to be repeated).
7. Send to Multinet.
8. Disconnect Multinet. **Remember to put dummy plug back on.**

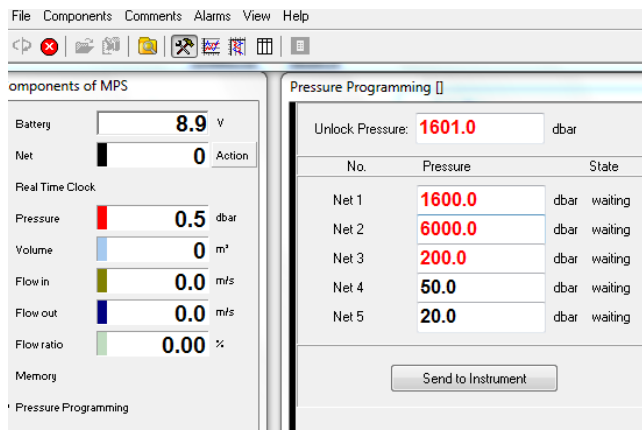

Fig. 9.3.1-3 Pressure programming. Unlock pressure needs to be deeper than opening depth of Net 1

→ **NOTE:** Depth of Net 2 is wrong in this picture, should be 600m

→ If not all the net opened during the previous deployment, check that the small pin of the rotating cylinder that controls the opening of the nets, is in the right position, pointing straight up towards the pin at the net (see picture above). If not mark *Net* and reset the rotating cylinder either by using *reset counter* or *half step*.

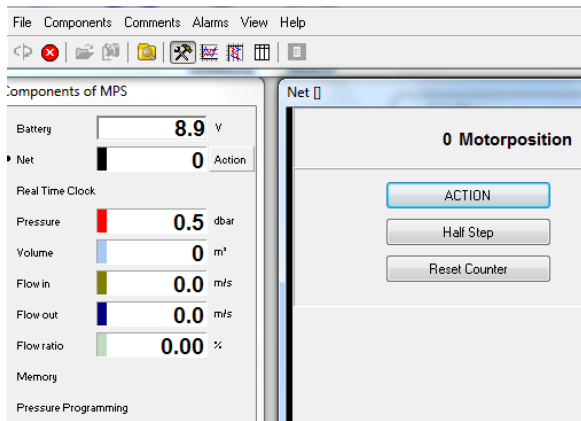

Fig. 9.3.1-4 Mark Net in the right menu and use Half step to reset rotating cylinder

9. Prepare the nets (strain the spring by using the bar to lift them into position).



Fig. 9.3.1-5 The springs are in this position before they are strained.

- Net #1 samples the deepest layer, Net# 5 the surface layer.
- Make sure that cod ends are placed at the right net!
- Make sure that the nets are not twisted before the Multinet is lowered into the water.
- The weight of the lower part of the Multinet should be entirely supported by the ropes and not by the nets! The nets have to hang loose, the ropes should be straight.
- More information can be found in the "Multiplankton Operational Manual from HydroBios".

9.3.2 MIK

Specifications: Metal ring with diameter of 2 m, with a 14 m long net. Mesh-size of the net is 1.5 mm, except for the last 1.5 m of the rear part, where mesh-size is 500 µm.

For oblique hauls, a depressor is used, preferably a “saddle-shaped” Scripps-depressor, but an IKMT-depressor can also be used.

NB! A flowmeter is attached in the centre of the opening for estimation of filtered volume whenever sampling with MIK. This is particularly important when sampling by V-hauls, as a lack of flowmeter implies that no reliable estimation of volume filtered can be made.

For more information - see the protocols «ICES 2013» & «ICES 2016».

Oblique V-hauls:

- Deploy the MIK with 25 m/min. (0.4 m/s) while keeping ship speed as low as possible (steering speed) until desired lower sampling depth is reached.
- Once at lower sampling depth, heave the MIK with 15 m/min. (0.25 m/s) while holding a ship-speed of 3 knots throughout the haul.
- Flowmeter mounted in centre of the ring.
- Use a depressor – preferably saddle-shaped
- Depth measured by Scanmar depth-sensor or trawl-probe (mounted on the ring).
- Deployed from shipside, or if required behind the ship.
- Use 10 m long «bridles» - which requires a large «block» in the crane.

Vertical hauls:

- 4 wires connected to the ring for increased stability
- Flowmeter mounted in centre of the ring.
- No depressor
- Attach weights to the rear end or cod-end of the MIK (20-30 kg)
- Depth measured by Scanmar depth-sensor or trawl-probe (mounted on ring).
- Deploy slowly 0.3 m/s to avoid the collecting bucket from flipping around.
- From desired lower sampling depth, heave with 1.5 m/s throughout the water-column

Literature:

- Anon. 1990. Manual for the International Young Fish Surveys in the North Sea, Skagerrak and Kattegat.
- ICES 2013. Manual for the Midwater Ring Net sampling during IBTS Q1. *Series of ICES Survey Protocols SISP 2-MIK 2*. 18pp.
- ICES 2016. Interim report of the Working Group on North Sea cod and plaice egg survey in the North Sea 2 (WGEGGS2). *ICES CM 2016/SSGIEOM:26*.
- Munk, P. 1988. Catching large herring larvae: Gear applicability and larval distribution. *J.Cons.int.Explor.Mer*, 45:97-104.
- Wiebe, P.H., D. Allison, M. Kennedy, G. Moncoiffé 2015. A vocabulary for the configuration of net tows.
- Hassel, A., Endresen, B., Martinussen, M., Gjertsen, K., Knutsen, T., Johannessen, M. (2018). Prosedyrer for prøvetaking og pre-analyse av dyre- og planteplankton på forskningsfartøy og i laboratorium på land. Versjon 4.0 (november 2018). Havforskningsinstituttets kvalitetshåndbok.

9.3.3 Macroplankton trawl

Specifications: 38 m² mouth opening, mesh-size of 3x3 mm throughout the trawl – from opening to cod-end, total length of about 45 m.

Background info: The Macroplankton trawl (Melle et al., 2006; Wenneck et al., 2008, Krafft et al., 2010; Heino et al., 2011) has been used regularly by IMR since 2010 to obtain quantitative samples of macrozooplankton, particularly for krill, amphipods, shrimps, and mesopelagic fish. This trawl will also give improved quantitative estimates of various types of jellyfish, in particular for scyphozoans but also for ctenophores.

For safety reasons the trawl can only be used as deep as the trawl-floats are specified for!

Deployment: V-hauls are applied for quantitative estimation of macrozooplankton abundances. The aim is that the trawl moves through the surrounding water with a speed of ca. 2.5 knots (affected by both vessel-speed and release/hauling-speed of wire) – both on the way down and up. After the trawl has reached its maximum depth, ship speed should be approximately

2.0 knots while the trawl is hauled obliquely towards the surface - heave as slowly as possible. Make sure that the height of the trawl opening is ca. 5 m during trawling – large departures from this height are an indication that the trawl is not behaving as it should – and the sample may then not valid.

It is important to attach a Scanmar trawl-eye and speed sensor for monitoring trawl performance. Data from these sensors must be logged on the computer at the ships bridge for later determination of trawl profile and volume of water sampled.

The trawl is to be used with standard pelagic trawl doors, sweep-length of 70 m, and 150-200 kg of weights (chain-weights 75-100 kg on each side), and 8 m strapping between the wings. More details regarding rigging of the trawl can be found in the IMR's Plankton Manual (pages 13-15).

Literature

- Heino, M., Porteiro, F.M., Sutton, T.T., Falkenhaus, T., Godø, O.R., Piatkowski, U., 2011. Catchability of pelagic trawls for sampling deep-living nekton in the mid-North Atlantic. *ICES Journal of Marine Science* 68, 377–389.
- Krafft, B.A., Melle, W., Knutsen, T., Bagøien, E., Broms, C., Ellertsen, B., Siegel, V., 2010. Distribution and demography of Antarctic krill in the Southeast Atlantic sector of the Southern Ocean during the austral summer 2008. *Polar Biology* 33, 957–968.
- Melle, W., Abrahamsen, M., Valdemarsen, J.W., Ellertsen, B., Knutsen, T. 2006. Design and performance of a new macro-plankton trawl in combination with a multiple cod-end system. *SCOR Working Group 115, Mini Symposium on Standards for the Survey and Analysis of Plankton*. Plymouth, England. 19-20 May 2006.
- Wenneck, T.dL., Falkenhaus T., Bergstad OA (2008). Strategies, methods, and technologies adopted on the R.V. G.O. Sars MAR-ECO expedition to the Mid-Atlantic Ridge in 2004. *Deep Sea Research II*. 55: 6-28.

9.3.4 WP2, WP3 & Bongo net manual

Specifications:

- WP2 stainless steel ring, diameter 57 cm, net 180 µm & 64 µm mesh size, length 2.6 m
- WP3 stainless steel ring of diameter 1 m, mesh size 1000 µm, length 2.6m

Deployment: Both WP2/ WP3 nets are deployed vertically. Both nets can be closed at specific depth by use of a messenger if needed.

→ **How to fix the net:** Connect the ring to the net (see picture guide below)



Connect the cup to the net





Insert the cup in the metal box



Connect the box to the net



→ NOTE: no twists (check before and during the net deployment)

Check presence of holes in the net (after each sampling) and eventually use tape to repair it



→ NOTE: Check the safety closure for the cup



10. Benthic sampling

This section contains information on planned seafloor sampling during joint AeN cruises. It has a focus on benthic organism sampling and processing as well as sediment sampling and processing where of joint biological-geological interest. We refer to sampling protocols provided by the geology team in several cases and for variables not of direct relevance to biologists in the project.

10.1 AEN TEAM MEMBERS INTERESTED IN BENTHIC INVERTEBRATE SAMPLES AND SEABED SEDIMENT SAMPLES

Sediment sampling is relevant for RF1 and RF3. Benthic invertebrate sampling is mostly relevant for RF3, with Foraminifera also of interest for RF1. Researchers interested in seafloor sampling (as of April 2018) are listed in Table 10.1-1. This list will obviously need updating as PhD students and Post-docs are hired into the project and other team members join.

Tab. 10.1-1 Researchers interested in biological seafloor sampling in the Nansen Legacy as off August 2019.

RF / RA	Name	Inst.	Role	Topic	Mail address
RF1, 3	Elisabeth Alve	UiO	Sci	Foraminifera	elisabeth.alve@geo.uio.no
RF1	Murat Ardelan	NTNU	Sci	Trace metals	murat.v.ardelan@ntnu.no
RF3	Bodil Bluhm	UiT	Sci	Biodiversity & community structure, food webs, population dynamics	bodil.bluhm@uit.no
RF3	Lise Øvreås	UiB	Sci	Sediment microbial communities	lise.ovreas@uib.no

RF3	Raphaelle Descoteaux	UiT	PhD (Arctic SIZE)	Meroplankton, benthic juveniles, barcoding, molecular diets	raphaelle.descoteaux@uit.no
RF3	Lis L. Jørgensen	IMR	Sci	Biodiversity & community structure, traits, vulnerability, management	lis.lindal.joergensen@hi.no
RF3	Paul Renaud	APN	Sci	Benthic community respiration,	per@akvaplan.niva.no
RF3	Luka Supraha	UiO	PhD	Phytoplankton spores	luka.supraha@ibv.uio.no
RF3	Emmelie Åström	UiT	PD	Food web, stable isotopes	emmelie.k.astrom@uit.no
RF3	NN	IMR	PD	Food web	
RF3	Snørre Flo	UNIS /UiT	PhD	Molecular diets plankton / meiofauna	snorre.flo@uit.no
RF1, 3	Thaise Ricardo de Freitas	UiO	PhD	Foraminifera	tba
RF3	Arunima Sen	Nord	PD	Benthic processes	Arunima.sen@nord.no
RF3	Eric Jorda Molina	Nord	PhD	Macrofauna community	eric.jorda-molina@nord.no
RF3	Yasemin Bodur	UiT	PhD	IP25, Biogenic Silicate	yasemin.v.bodur@uit.no
RF3	Marti Amargant Arumi	UiT	PhD	Diatom spores	marti.a.arumi@uit.no
RF3	Andreas Altenburger	UiT Museum	Sci	Museum collection	tba

RF1,3	Silvia Hess	UiO	Sci	Benthic forams/commu nity	silvia.hess@geo.uio.no
-------	-------------	-----	-----	---------------------------------	------------------------

10.2 BENTHIC SAMPLING GEAR

Sampling gear targeting sediment and organismal samples in AeN is listed in Table 10.2-1. Benthic meiofauna will be sampled with a Gemini-corer (back up gear is a box core).

- **Macrobenthos** (terms used synonymously with infauna here) and microbes will be sampled with a box corer (back up gear is a van Veen grab),
- and **Megabenthos** (term used synonymously with epifauna here) will be sampled with beam and Campelen trawls.
- **Sediment** for shared biological and geological variables will be sampled with a box corer (again, back up gear is a van Veen grab).

Naturally, the sampling depth of all sampling gear matches the total depth of a given station. Appropriate knowledge of the bottom depth from the ship's depth sounder is, therefore, a requirement. Knowledge on bottom topography and sediment type from multi-beam mapping is desirable.

→ **NOTE** that geologists prefer multi-corer samples for their measurements and will use that gear type during their cruises. In joint cruises where no geologists participate, select sediment properties will be sampled from box cores.

The gear will primarily be handled by the crew. Scientists, however, need to have the gear ready for deployment. Given that Kronprins Haakon is a new vessel with a new crew, it is advisable to discuss the procedures of deployment with them. This section briefly summarizes key facts about each gear deployment. At the date of this draft, not all gear features have been clarified.

Tab. 10.2-1 Sampling gear for sediment and benthic organisms to be used during AeN (in alphabetic order). Method responsible and affiliation, potential users, sampling goals and cruise information also given.

Gear type	Owner(s)/ responsible	Potential users	Sampling goals	Cruises
Beam trawl (10.2.1)	IMR/Jørgensen	RF3	Epifauna for population parameters / ECOPATH, fish, food web, barcoding, contaminants	All JC / seasonal cruises
Box corer (10.2.2)	Geology UiT/Forwick, NPI/Husum	RF1, 3 (??)	Sediment grain size, organic carbon content, pigments (chlorophyll, phaeopigments), macrofauna (juveniles / adults, for experiments, quantitative, for population parameters / ECOPATH), fauna, food web, pH (Geo cruises), oxygen (Geo cruises)	All JC / seasonal cruises
Campelen trawl (10.2.3)	IMR/Jørgensen	RF3	Epifauna (quantitative); for population parameters / ECOPATH, fish, food web, barcoding, contaminants	All JC / seasonal cruises
Gemini core (10.2.4)	UiO/Alve	RF1/3	Foraminifera (quantitative, for experiments); all meiofauna for quantitative estimates, food web (isotopes, molecular diets)	Seasonal cruises
Van Veen grab (10.2.5) → backup for Box corer	BFE UiT/Bluhm, APN/Renaud	See box core	See box core	All JC / seasonal cruises

10.2.1 Galvanize steel beam trawl (Figure 10.2 – 1 A,B)

Specifications: Specs. in Jennings et al. (1999), Mesh size: 20 mm (10 mm knot to knot)

Introduction:

- 1 haul per station
- Effective opening: 2 m
- No sensors
- Trawl data needed: latitude / longitude at bottom and off bottom, water depth, time at bottom and off bottom, station number, ship speed (available on screens around ship)

Deployment:

- Deploy at scope ca. 2
- Bottom time 3 min
- Trawl at 1.5 kn
- Wire in / out at 1 m s^{-1}
- Empty on deck / sorting table

10.2.2 Box corer (Figure 10.2 – 1 E)

Specifications:

- Box size: 0.5 x 0.5 x 0.5 m
- Amount of weight on top: 4 x 25 kg or 4 x 50 kg

Introduction/Requirements:

- 3-4 cores per process station (where surface is undisturbed). This number will include ALL benthic sampling needs (respiration, pigments/sediment parameters, community analysis, cores for experiments, etc.)
- Data needed: latitude / longitude, water depth

Deployment:

- To deploy, open spade
- Fix release mechanism to keep spade open

- Lower to seafloor at 1 m s⁻¹
- Lower speed to 0.5 m s⁻¹ near seafloor to avoid loss of sediment surface layer and organisms
- Weight will push core into sediment
- Release will pop out upon the corer touching the seafloor
- Upon slow retrieval from sediment, spade will close
- Place on deck very carefully to reduce sediment surface disturbance
- Upon retrieval, unscrew box with sediment sample, fix new box for next replicate
- For retrieved box core, follow sediment sampling protocols
- Before placing the cores on the sediment, remove some of the water from the surface (leaving some) with tubes (without disturbing the sediment) and pass the water through a 60 µm sieve (so that possible hyperbenthos is retained)
- Before the rest of the water is retrieved, stick all sampling cores in the box corer sediment (except from the ones for incubations, the 11,7 cm in diameter ones)
- Cores should be taken from undisturbed surface areas (e.g., not too close to the edges or in depressions or on elevations).
- Now, remove the rest of the water from outside of the cores following same procedure as before
- After removing as much water as possible, place incubation cores on the box corer sediment (try to avoid having water inside the incubation cores, since in the processes of retrieving the cores the shaking will produce waves and disturb the sediment surface → not good for the experiments!).

10.2.3 Campelen 1800 with Rockhopper ground-gear trawl (10.2 – 1 C,D)

Specifications: Mesh size: 80 mm in wings, 16-22 in the cod end;
Specs in Engås and Ona (1990)

Introduction:

- Trawl data needed: latitude / longitude at bottom and off bottom, water depth, time at bottom and off bottom, station number, ship speed, door opening
- scanmar sensors (available on screens around ship)

Deployment:

- 1 haul per main station
- Bottom time 15 min (should be equivalent to towing distance of ca. 0.75 nautical miles or 1.4 km)
- Trawl speed ~3 kn
- Target net opening ca. 17 m horizontal, 4 m vertical
- Deploy at scope appropriate to depth and sediment (get from fish team)
- Wire in / out at 1 m s⁻¹
- Empty into chute that leads to inside fish sorting table

10.2.4 Gemini corer (Figure 10.2 – 1 F)

Specifications: Corer contains 2 cores, 8 cm diameter each

Introduction:

- number of replicate hauls: 3 per station
- Deploy at 1 m s⁻¹
- Data needed: latitude / longitude, water depth, core length

Deployment:

- Max. penetration depth about 60 cm
- Lower speed when the corer approaches the sea floor to about 0.5 – 0.8 m s⁻¹ (depends on the substrate and may differ between stations)
- Weight may also be adjusted (0 to 3 pieces of lead which come with the corer)
- Place on deck very carefully, since undisturbed surface is essential

10.2.5 van Veen Grab (back up to Box corer) (Figure 10.2 – 1 E)

Specifications: Sample surface area: 0.1 m²

Introduction:

- In case box corer cannot be used, replicates per station: 4-5
- Data needed: latitude / longitude, water depth, fullness of grab

Deployment:

- Store and handle with safety pin in place, for deployment release safety pin
- open jaw and push pinch-pin with spring in place, keep pressure on pin (other types have a little metal hook instead)
- lift grab over board with winch
- lower at 1 m s⁻², slower near bottom
- pinch-pin (or metal hook) will pop out when grab reaches the bottom and wire is no longer under tension
- pulling up cable gently will close jaws, swing grab over tub or sieve
- discard grabs that are less than half full, or where the sediment overflows through the windows

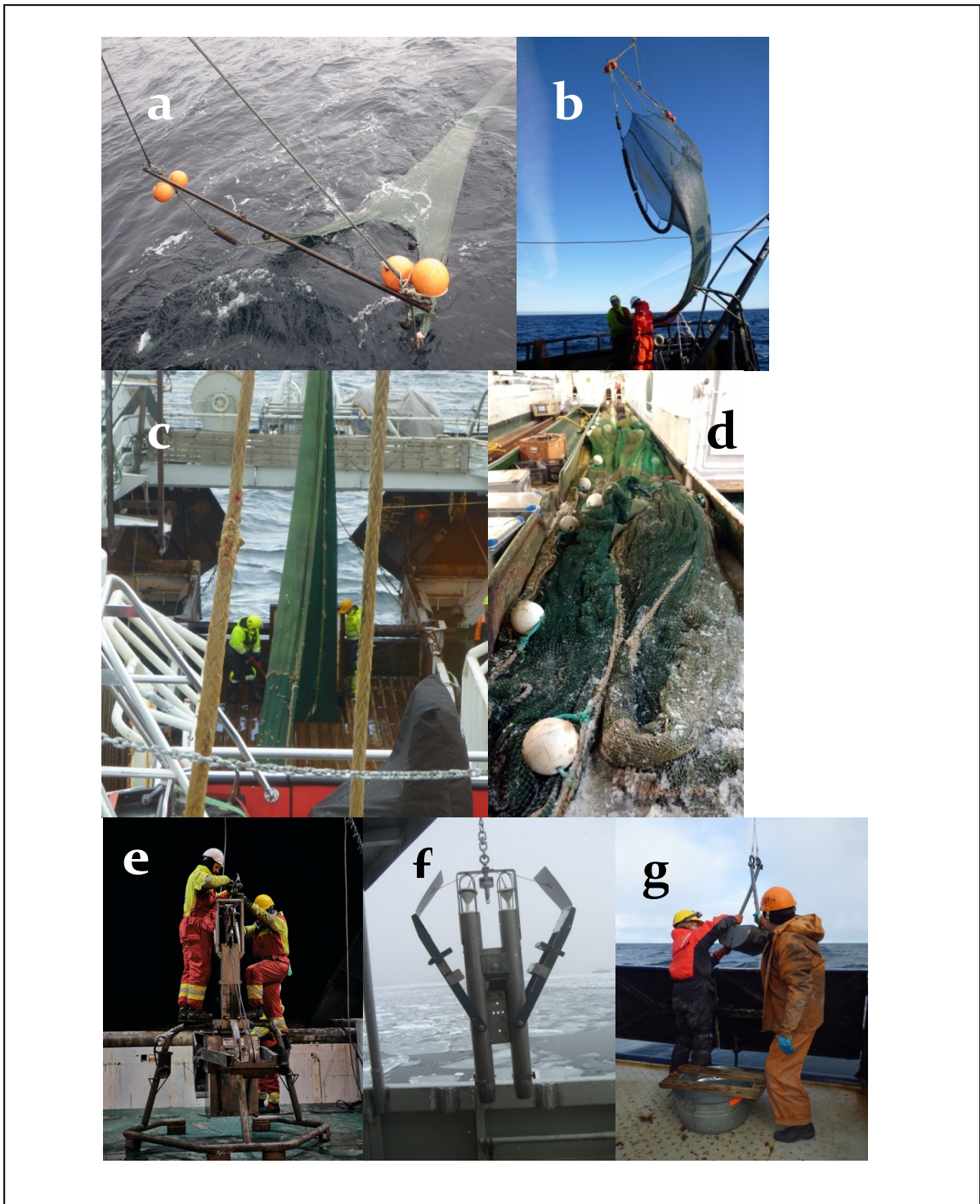

Fig. 10.2-1 Sediment / benthic sampling gears to be used during Arven etter Nansen cruises. A-B) Beam trawl, C-D) Campelen trawl (photos: B. Bluhm), E) box core (photo: R. Hjertenes), F) Gemini corer (photo S. Hess), G) van Veen Grab. (photo B. Bluhm).

10.3 SEDIMENT AND BENTHIC INVERTEBRATE SAMPLING

Sampling procedures for sediment and benthic invertebrates are outlined here. Not all sampling may be conducted on all cruises. **NOTE:** Additional sampling specific to a particular objective, requiring extensive training and/or only conducted on a single or few cruises is not listed here.

→ **Sample labelling:** A sample labelling system was developed for the entire project and was introduced on JC1-2 in August 2018. This system includes a labelling code and provides labels on chemical and water proof paper. See [labelling protocol](#).

→ **Sample processing:** Lab processing notes are very brief at this point, full protocols are not provided here, but can be obtained from the responsible labs.



Fig. 10.3-1 Biological sample taking procedures. Top left) Box core sampling, top right) emptying van Veen grab into a tub for sieving, middle left) Sectioning Gemini core (and sampling container), bottom left) sorting trawl sample, bottom right) sieving macrofauna (from van Veen / box core). (Photos S. Hess, B. Bluhm).

10.3.1 Sediment pigments (Box corer sampling)

Measured parameter/name: Sediment pigments (HPLC analysis)

Method Responsible: Paul Renaud (APN, per@akvaplan.niva.no)

Description of parameter/Aim: Concentration of pigments in the sediment.
Measured in mg/m²

Methodological description:

→ **Special requirements/Gear:** Box corer

→ **Sampling depths:** Station bottom depths

→ **Chemicals used:** none, but samples frozen at -80°C

Method:

- Use Cut-off 60-ml plastic syringe
- Collect 3 replicates per station, but one per box core (ie, 3 samples from 3 different box cores per station)
- insert syringe into the surface of the box core to a bit more than the sampling depth of 2 cm
- pull out gently by turning such that the sediment does not get lost
- place sediment "plug" in a plastic whirl-pak / zip lock bag
- wrap in aluminum foil
- freeze at -80°C

→ **Sampling storage:** Akvaplan-niva, Tromsø

→ **Shipping address:** c/o Paul Renaud, Akvaplan-niva, Fram Centre, 9296 Tromsø (TRANSPORT: on plane, as checked in baggage (Arunima Sen))

10.3.2 Benthic chlorophyll *a*/phaeopigments (Box corer sampling)

Measured parameter/name: chlorophyll *a*, phaeopigments/ Sediment pigments (fluorometric)

Method Responsible: Paul Renaud (APN, per@akvaplan.niva.no)

Description of parameter/Aim: concentration of fluorometrically measured pigments in the sediment. Measured in mg/m².

Methodological description:

- **Special requirements/Gear:** Box corer
- **Sampling depths:** Station bottom depths
- **Chemicals used:** none, but samples frozen at -20 C

Method:

- Use 4.7 cm inner diameter core
- Collect 3 replicates per station, but one per box core (ie, 3 samples from 3 different box cores per station)
- insert core into the sediment in the retrieved box core.
- Use shovel or hands to dig in and remove the core, keeping bottom covered
- Extrude the core with specialized extruder in the following sections: 0-1 cm, 1-2 cm, 2-3 cm, 3-4 cm, 4-5 cm, 5-6 cm, 6-8 cm, 8-10 cm.
- Place each sediment section in a plastic whirl-pack/Ziploc bag.
- Wrap bags with aluminium foil
- Freeze at -20°C

→ **Sample storage:** Akvaplan-niva

→ **Shipping address & Transport:** c/o Paul Renaud, Akvaplan-niva, Fram Centre, 9296, Tromsø - on plane, as checked in baggage (Arunima Sen)

10.3.3 Sediment grain size and sediment carbon, nitrogen and stable isotopes (Box corer sampling)

Measured parameter/name:

- Sediment TOC: total organic carbon (TOC). Units: %
- Sediment TN: concentration of total nitrogen (TN). Unit: %
- Sediment stable isotopes (C and N): carbon and nitrogen stable isotope ratios. Unit : ‰
- Sediment grain size: fraction of the sediment corresponding to specific grain sizes. Measured as percentage of sizes (e.g., % < 63 µM).

Method Responsible: Elisabeth Alve (elisabeth.alve@geo.uio.no) and Silvia Hess (silvia.hess@geo.uio.no)

Description of parameter/Aim:

- Organic carbon and total nitrogen content of sediment and stable isotope ratios for both carbon and nitrogen. Units above
- grain size of sediment, or, fraction of the sediment corresponding to specific grain sizes. Units above.

Methodological description:

- **Special requirements/Gear:** Box corer
- **Sampling depths:** Station bottom depths
- **Chemicals used:** none, but samples frozen at -20C

Method:

- Use 5.5 cm inner diameter core
- Collect 3 replicates per station, but one per box core (ie, 3 samples from 3 different box cores per station)
- insert core into the sediment in the retrieved box core.
- Use shovel or hands to dig in and remove the core, keeping bottom covered
- Extrude the core with specialized extruder in the following sections: 0-1 cm, 1-2 cm, 2-3 cm, 3-4 cm, 4-5 cm, 5-6 cm.
- Place each sediment section in 60 ml Cerbo boxes or in small plastic bags.

- Freeze at -20°C

→ **Sample storage:** UiO

→ **Shipping address/Transport:** c/o Elisabeth Alve, Geologibygningen, University of Oslo, Sem Sælands vei 1, 0371 Oslo - Transport: on plane, as checked in baggage (Silvia Hess)

10.3.4 Sediment microbes (Box corer sampling)

Measured parameter/name: microbial community, parameter name: Sediment microbes

Method responsible: Lise Øvreås (UiB, Lise.Ovreas@uib.no)

Description of Parameter/Aim: Identification and quantification of sediment microbial community. Measured in abundance.

Methodological description:

→ **Special requirements/Gear:** Box corer

→ **Sampling depths:** Station bottom depths

→ **Chemicals used:** none, but samples frozen at -80°C

Method:

- Use 4.7 cm inner diameter core
- Collect 3 replicates per station, but one per box core (ie, 3 samples from 3 different box cores per station)
- insert core into the sediment in the retrieved box core.
- Use shovel or hands to dig in and remove the core, keeping bottom covered
- Extrude the core with specialized extruder in the following sections: 0-1 cm, 1-2 cm, 2-3 cm, 3-4 cm, 4-5 cm, 5-6 cm.

- When a section has been extruded, take a sample from the **middle** of the section with a 60ml syringe to avoid contamination.
- Place the sample in a plastic whirl pack or Ziploc bag.
- Freeze at -80°C

→ **Sample storage:** UiB

→ **Shipping address & Transport:** c/o Lise Øvreås, Centre for Geobiology, University of Bergen, Thormøhlensgate 53B, Bergen - needs to be shipped to shipping address with samples in dry ice.

10.3.5 Foraminiferal community and metazoan meiofauna community (Box corer sampling)

Measured parameter/name: Benthic foraminiferal and metazoan meiofauna community. Measured in abundances/Parameter name: Sediment forams and Metazoa meiofauna

Method responsible: Elisabeth Alve (elisabeth.alve@geo.uio.no) and Silvia Hess (silvia.hess@geo.uio.no)

Description of Parameter/Aim: identification and quantification of benthic foraminiferal community (remaining sample material is kept for metazoan meiofauna analysis)

Methodological description:

- **Special requirements/Gear:** Box corer
- **Sampling depths:** Station bottom depths
- **Chemicals used:** rose Bengal in 70% ethanol (2g/L)

Method:

- Use 5.5 cm inner diameter core liner

- Collect 3 replicates per station, but one per box core (ie, 3 samples from 3 different box cores per station)
- insert core into the sediment in the retrieved box core.
- Use shovel or hands to dig in and remove the core, keeping bottom covered
- Extrude the core with specialized extruder in the following sections: 0-1 cm, 1-2 cm, 2-3 cm, 3-4 cm, 4-5 cm, 5-6 cm.
- Place section in (180 ml Joni) container and add the same volume of rose Bengal stained 70% ethanol (2g rose Bengal/1l ethanol) as sediment volume (1:1).
- Shake gently to homogenize so all sediment clumps are disintegrated.
- Do not freeze
- Note: in the lab, after sorting for forams, same samples can be used for determining meiofaunal community composition.
- Macrofauna in the >500 µm-fraction sent to Henning Reiss.

→ Sample storage: UiO

→ Shipping address & Transport: c/o Elisabeth Alve, Geologibygningen, University of Oslo, Sem Sælands vei 1, 0371 Oslo - needs to be shipped to shipping address. No special temperature needs (but do not freeze).

10.3.6 Biogenic Silica (Box core sampling)

Measured parameter/name: Biogenic Silica

Method responsible: Yasemin Bodur (UiT, yasemin.v.bodur@uit.no)

Description of Parameter/Aim: proxy for diatoms

Parameter name: Biogenic Silica

Methodological description:

→ **Special requirements/Gear:** Box corer

→ **Sampling depths:** Station bottom depth

→ **Chemicals used:** none

Method:

- Use 60 ml cut-off syringe
- Sample the first 5 cm of surface sediment
- Slice 5 cm at intervals of 1 cm (only about 50 mg per sample needed)
- Slices can be stored in plastic bags at -20°C

→ **Sample storage:** UiT

→ **Shipping address/Transport:** UiT Norges arktiske universitet, Postbox 6050 Langnes, 9037 Tromsø; **Transport:** cooler or on plane, as checked in baggage

10.3.7 Diatom spores (Box core sampling)

Measured parameter/name: Germination rate and community composition/Diatom spores

Method responsible: Martí Amargant Arumí (UiT, marti.a.arumi@uit.no)

Description of parameter: Germination (exposure to light and nutrients) of diatom and other protist resting stages present in the sediment and characterization of the resulting community composition through DNA metabarcoding.

Methodological description:

→ **Special requirements/Gear:** Box corer

→ **Sampling depths:** Station bottom depth

→ **Chemicals used:** none

Method:

- Work as dark as possible (i.e. red-light headlamps).
- Use cut-off 60mL plastic syringes.
- Collect 3 replicates from one box core, only from stations P1 and P7.

- Insert syringe into the surface of the box core to a bit more than the sampling depth of 1 cm.
- Pull out gently by turning such that the sediment does not get lost
- Place sediment “plug” in a plastic whirl-pak / zip lock bag
- Wrap in aluminum foil

→ **Sample storage:** Sample is utilized immediately in on-board experiments. Resulting samples eventually stored at UiT. No shipping needed.

10.3.8 Benthic respiration and uptake experiments (Box corer sampling)

Measured parameter/name: sediment community oxygen consumption/
Sediment community oxygen consumption

Method responsible: Paul Renaud (per@akvaplan.niva.no)

Description of Parameter/Aim: measuring benthic oxygen consumption. Measured as a rate (mmol O₂/m²)

Methodological description:

→ **Special requirements/Gear:** Box corer and Niskin water samples from bottom

→ **Sampling depths:** Station bottom depths

→ **Chemicals used:** sodium sulfite needed for calibration of oxygen system (and note that chemicals will be used for macrofaunal community post incubation)

Method:

- Use 11.7 cm inner diameter core.
- Collect 6 replicate cores per treatment per station (possibly leave out algal treatments at deep sites):
 - Treatment 1: respiration at ambient water temperature

- Treatment 2: respiration at ambient water temperature + addition of 30 mg of labeled algae. (Treatment 3: respiration at ambient water temperature + 4°C (+2°C in deep water)
 - Treatment 4: respiration at ambient water temperature + 4°C + addition of 30 mg of labeled algae.)
- insert core liner into the sediment in the retrieved box core (ca 20 cm sediment).
- Insert all possible cores and sub-cores for other benthic sampling. Remove sub-cores first, to ensure the least amount of sediment is left when incubation cores have to be removed.
- Use shovel or hands to dig in and remove the core, keeping bottom covered. Do not shake. Attach core bottom. Make sure it is secure.
- Clean the core while on deck.
- Transfer core to water bath in the appropriate (dark) cold room (Tubs in the cold rooms should be prefilled with seawater in advance to maintain desired temperature).
- Use water from Niskin bottles to fill up the core to the top. This has to be done very slowly so as not to disturb the sediment surface. A paper circle (piece of water-resistant paper cut in a circle) can be used to help pour the water in slowly.
- Measure the height of the sediment in each core from at least three different locations (sides of the core).
- Add an air stone to each core (place as gently as possible so as not to disturb sediment surface) and allow to aerate for 1-2 h.
- Put on the top cores (leads) and attach to the electrical unit. Make sure that the stir bar is stirring (not too slowly, but also not too vigorously).
- Fill the last bit of water up via the small opening on the top of the core. Then plug it with the rubber stopper and try to avoid air bubbles.
- Check the temperature of the water in the water bath/tub.
- Take an oxygen reading and make sure that oxygen is at the max.
- Every few hours, take oxygen readings via the spot on the top of the cores using the PreSense Fibox 4 system according to manufacturer recommendations.
- Maintain cores IN THE DARK. Use headlamp for taking regular oxygen measurements.
- Check water temperatures when oxygen readings are taken.
- Continue taking measurements till oxygen comes down 15-30% from 100% saturation (meaning when it comes down to 85% to 70% of oxygen concentration). With Paul we agreed that we should not wait until lower than 50%

- (After the termination of the experiment quantitative foraminifera sub-samples will be collected, and the rest of the sediment in the core is processed for macrofaunal analysis)

→ **Sample storage:** no long-term storage required; experiments will be terminated onboard. However, experimental cores will be saved for macrofaunal and foraminifera sampling.

→ **Transport: Shipping address:** c/o Henning Reiss, Morten Krogstad, Nord Universitet Forskningsstasjon, Mørkvedbukta 26-28, 8020, Bodø

10.3.9 Quantitative macrofaunal assemblage (Incubation cores from Box corer sampling)

Measured parameter/name: Macrofauna abundance/Sediment macrofauna

Method Responsible: Paul Renaud (per@akvaplan.niva.no) and Henning Reiss (henning.reiss@nord.no)

Description of parameter/Aim: identification and quantification of sediment macrofaunal community. Measured in abundance

Methodological description:

→ **Special requirements/Gear:** Box corer and cores used for benthic respiration experiments

→ **Sampling depths:** Station bottom depths

→ **Chemicals used:** Formaldehyde 37% diluted to ~4% with seawater, mixed with buffer borax, Rose Bengal (add preweighed 4 g Rose Bengal vial to 5L of 37% formaldehyde. Dilute this mixture 9:1 with seawater and borax to obtain the working solution).

Method:

- Cores used for respiration experiments will be used.
- For treatments 1 and 3, sediment from cores will be gently sieved using a 500- μ m sieve. For treatments 2 and 4, this will be done after sub-sampling for foraminifera
- Transfer retained animals and detritus to a sample jar using forceps and squirt bottles
- Add buffered 4% formaldehyde-seawater-Rose Bengal solution to jars (2 parts formaldehyde solution to 1 part retained sediment)
- Never fill jar completely full with fauna/sediments – they will not preserve well
- Gently turn over sample a few times to ensure preservative fully penetrates the sample
- Seal lids with electrical tape (and possibly parafilm)
- Keep containers in chemical locker. DO NOT FREEZE.

→ **Sample storage:** Nord University

→ **Shipping address/Transport:** c/o Henning Reiss, Faculty of Biosciences and Aquaculture, Universitetsalléen 11, 8026, Bodø; **Transport:** needs to be shipped to shipping address. No special temperature needs (but do not freeze).

10.3.10 Incubation cores from Box corer sampling: Quantitative foraminiferal assemblage

Measured parameter/name: Benthic foraminiferal abundance and carbon uptake/incubation experiment benthic foraminifera

Description of Parameter/Aim: identification and quantification of benthic foraminiferal community, contribution of foraminiferal community to benthic respiration rates, incorporation of labeled algae.

Method Responsible: Elisabeth Alve (elisabeth.alve@geo.uio.no) and Silvia Hess (silvia.hess@geo.uio.no)

Methodological description:

→ **Special requirements/Gear:** Box corer and cores used for benthic respiration experiments

→ **Sampling depths:** Station bottom depths

→ **Chemicals used:** none, but samples frozen at -20 °C.

Method:

- Sub-cores from respiration experiments, Treatments 2 and 4 will be used.
- After incubation, cut the incubated sediment cores horizontally in 0-1 cm and 1-2 cm slices. From each slice, 20 ml of carefully homogenized sediment are taken with a cut syringe for foraminiferal analysis. The rest sediment returns to the macrofauna samples.
- Place sediment in 60 ml Cerbo plastic container
- Freeze at -20 C.

→ **Sample storage:** UiO

→ **Shipping address&Transport:**

c/o Elisabeth Alve,
Geologibygningen
University of Oslo,
Sem Sælands vei 1
0371 Oslo

Transport: on plane, as checked in baggage (Silvia Hess)

10.3.11 Quantitative epibenthic megafauna (Beam trawl & Campelen trawl)

Measured parameter/name: Epibenthic megafauna abundance/biomass

Method responsible: Lis L. Jørgensen (IMR, lis.lindal.joergensen@hi.no)

Description of parameter/Aim: Quantitative investigation of epibenthic megafauna by use of Beam and Campelen trawl. Species identifications, counts and food web analysis.

Methodological description:

→ **Special requirements/gear:** Beam trawl & Campelen trawl

→ **Sampling depths:** station bottom depth

→ **Chemicals used:** Formaldehyde 37%, Formaldehyde solution ~4%, buffer borax or hexamethylentetramine, Ethanol (95%, molecular grade)

Megafauna assessment:

- Sorting, enumerating and weighing is done onboard with fresh samples
- Formalin vouchers will be transferred to 70% ethanol
- Taxonomic identifications from ethanol-preserved samples are completed in the home lab and with the help of experts
- Data recording of counts and weights by taxon and archiving follows IMR's standard protocol

Method:

1. Take photo of catch with sample label
2. record sediment type (rocks, shell hash, mud, etc.) if visible
3. If catch is too large to sort in its entirety, subsample for abundant taxa after mixing the catch, note subsampling factor by weighing total catch and subsample, then sort subsample (for rare and large taxa, sample 100% and note which taxa were sampled this way)
4. Sort the catch, separating all obviously different taxa, put each in a container (big or abundant specimens into in buckets/tubs, small or rare taxa in trays/petri dishes)

5. Keep specimens in seawater to keep them fresh
6. Identify taxa to lowest practical taxonomic level; give descriptive names to unidentified taxa and keep them consistent throughout the cruise
7. Count and weigh by taxon (note weight unit), including macroalgae
8. Do not include empty shells and tubes in counts / weights
9. Place 2-5 individuals in 4% formaldehyde seawater solution as voucher with label (at least all taxa where the identification is not certain, better all taxa once per cruise) – under hood, with nitrile gloves on, DO NOT FREEZE
10. Do not discard catch before sampling for all other objectives is done!
11. Record data on counts, weights (with unit), sub-sampling factor, station and date on data sheet, enter data into provided data file

→ **Sample storage:** Sample storage to be determined (museum voucher collection at the Tromsø Museum is being discussed)

10.3.12 Stable carbon and nitrogen isotope analysis of benthic infauna and epifauna

Measured parameter/name: Stable carbon and nitrogen isotope ratios of organisms / Isotopes

Method Responsible: Lis L. Jørgensen (IMR, lis.lindal.joergensen@hi.no), Bodil Bluhm (UiT, bodil.bluhm@uit.no), NN Postdoc (IMR/UiT), Emmelie Åström (UiT, emmelie.k.astrom@uit.no)

Description of parameter/Aim: Food web structure analysis

Methodological description:

→ **Special requirements/Gear:** Campelen Trawl and Box Corer

→ **Sampling depths:** Station bottom depth

→ Chemicals used: none

Method:

Box corer:

- With a spatula, collect all remaining areas from the surface sediments of the box corer (upper 5 to max. 10 cm)
- Sieve the sediment through a 1 mm sieve (smaller is ok)
- Select dominant organisms, identify as best possible
- Ideally collect 3-5 specimens of same species per station where they occur
- Rinse organisms, store in small plastic bags, label, scan, bag by station and freeze at -20 degrees C
- Taxon wish list for seasonal comparisons, esp. south of Polar Front (P1) AND north of Polar Front (P2 and P4; no box coring at P5 because of rocks)
 - Nephtyidae
 - Maldanidae
 - Oweniidae
 - Terebellidae
- Taxon wishes deep stations (P6, P7 and other): all that comes up; identification to class is ok here

Campelen trawl:

- Sort dominant invertebrate and fish taxa from trawl haul
- identify taxa as best possible
- Ideally collect 3-5 specimens of same species per station where they occur
- Store in small plastic bags, label, scan, bag by station and freeze at -20 degrees C
- For very large organisms it is ideal to dissect a piece of muscle / body wall tissue (ca. 1x1x1 cm)
- Taxon wish list for seasonal comparisons, esp. south of Polar Front (P1) AND north of Polar Front (P2, P4 and/or P5 if trawls are taken)
 - *Astarte elliptica/sulcata*
 - *Bathyarca glacialis*
 - *Boreogadus saida*
 - *Buccinum hydrophanum*
 - *Ctenodiscus crispatus*
 - *Gersemia* sp.

- *Hippoglossoides platessoides*
- *Leptagonus decagonus*
- *Ophiacantha bidentata*
- *Pontaster tenuispinus*
- *Sabinea septemcarinata*

→ **Sample storage:** UiT

→ **Shipping address/Transport:** c/o Bodil Bluhm, UiT The Arctic University of Norway, BFE faculty, NFH building, 9037 Tromsø; **Transport:** must be kept frozen at -20 degrees C, ship to shipping address

10.3.13 Sampling for diet assessments of small invertebrates

Measured parameter/name: Small invertebrates in ethanol (metabarcoding for diet assessment), and small starved invertebrates in ethanol (false-positive control).

Method responsible: Snorre Flo (UNIS/UiT, snorre.flo@unis.no), Anna Vader (UNIS, annav@unis.no)

Description of parameter: Small invertebrates (<1 mm) are sampled from different habitats (ice-cores, pelagic net hauls and sediment samples) and fixed in ethanol. A subsample of the species (found in the species list below) will be targeted for a gut-evacuation step (starvation) prior to ethanol-fixation.

Methodological description:

→ **Stations:** All process stations with P1, P4, P5/6 and P7 prioritized

→ **Sample types:** Pelagic net hauls (bottom – 0 m), ice-cores (bottom 30 cm of core), sediment samples.

→ **Gear:** Bongo-net (64 µm), Ice-corer, box corer, freezer (-20°C, fridge/4°C storage room, standard stereomicroscope.

→ **Equipment:** 20-30 white plastic bottles (250 mL), 4 acid-washed glass

bottles (VWR borosilicate/Pyrex/Schott, 1 L), 4 acid-washed glass beakers (VWR borosilicate, 1-2 L), glass-pipettes (1 pack x 100), 0.22 µm Sterivex filters (1 pack), ethanol (96%, 12L), 15 and 50 mL Falcon tubes (1 bag of each), Eppendorf-tubes (2.5 mL, 1 bag), sorting sieves (64 and 1000 µm), bottle-cap sieves (64 µm), filtered sea-water (FSW), Squeeze-bottles (0.5 L),

→ **Chemicals:** Ethanol (96%), + Safety sheets.

Sample _____ **treatment:**

Pelagic samples (Bongo-net vertical hauls, 64 µm mesh-size, bottom to 0 m (1000 – 0 m for deep stations):

1. Transfer the sample from the cod-end to a beaker.
2. Gut evacuation step:
Gently transfer half of the sample to an acid-washed glass beaker (1000 mL) filled with FSW (0.22 µm-filtered, 800 mL) and keep at *in situ* temperature in darkness. **Perform Step 4 and 5 before you continue with gut evacuation.**
3. After steps 3 and 4 are done, pick small zooplankton from the beaker with a pipette and transfer them to an acid-washed 1 L glass bottle (blue cap) containing **cold** FSW. Alternatively, isolate small zooplankton with a 1000 µm sieve and discard any large organisms. Incubate for 48 h in darkness, and *in situ* temperature to perform the gut-evacuation step.
After 48h, filter the solution over a 64 µm sieve, and rinse off the organisms into a white non-transparent plastic bottle using a squeeze bottle with ice-cold ethanol (96%).
Store samples at -20°C .
4. Filter the remaining sample (e.g. the remaining solution from the initial glass beaker) through a 64 µm sieve. Discard any gelatinous/large organisms from the sieve.
 - Alternatively (if the organism abundance is low), transfer zip-lock bag-sample to a clean bottle, and remove water from the bottle by siphoning. Use a 64 µm mesh plankton net to retain small zooplankton in the bottle. Pour the remaining volume into a glass beaker, and perform Step 4 by transferring small zooplankton to a 250 mL plastic bottle with ice-cold ethanol (95%) using a pipette.

5. Rinse off organisms from sieve into a non-transparent 250 mL plastic bottle with ice-cold ethanol (96%) and store at -20°C
6. You should now have: i) bottle with small invertebrates in ethanol, ii) bottle with small starved invertebrates in ethanol.

Benthic samples (sediment taken with box corer, no gut-evacuation step for benthic samples):

1. Scrape two spoons of sediment from the surface with a clean spoon, and transfer to a 250 mL wide-mouth plastic bottle. Alternatively, if using a bottle with narrow opening → use a funnel and a squeeze bottle with ethanol (96%) to transfer sample into bottle.
2. **Immediately** top off with ethanol (96%) and store at -20°C..

Sympagic samples (ice-cores, 10 cm):

1. Saw off the ice core at 10 cm from the bottom. Keep the bottom 10 cm, top can be discarded.
2. Transfer the 10 cm section to a melt-bucket and add 100 mL FSW per cm (e.g. 1 L FSW for 10 cm core).
3. Keep at room-temperature until thawed. Swirl to keep temperature constantly low, and process immediately when thawed.
4. Gut evacuation step:
Transfer 100 mL of the thawed solution to an acid-washed 1 L glass bottle (blue cap) with cold FSW. Higher sample-volume might be needed if organism abundance is low (check in a stereomicroscope). Incubate for 48 h in darkness and 0°C to perform the gut-evacuation step. After 48h, filter the solution over a **20 µm sieve**, and transfer organisms into a white non-transparent plastic bottle with ice-cold ethanol (96%).
5. Filter the remaining thawed sample over a 20 µm sieve.
6. Transfer organisms to a white non-transparent water-bottle by “rinsing” with ice-cold 96% ethanol.
7. Top off with ethanol (96%) and store at -20°C.
8. You should now have: i) bottle with small invertebrates in ethanol, ii) bottle with small starved invertebrates in ethanol.

Gut evacuation-step explained:

This step should be executed at least once per species per cruise with at-least 5 individuals per species (~10 are desirable). Starved individuals are to be

processed via the same metabarcoding pipeline used for diet analyses, so as to enable identification of parasites, mutualists and occurring eDNA that would otherwise be interpreted as prey items (false-positives).

Table 10.3.13-1 Species list. Priority species in bold.

Sympagic meiofauna	Feeding mode	Reported prey	Depth (m) [53]	Mol. diet	COI (BOLD)	18S (GenBank)
Rotifera						
<i>Proales reinhardti</i> (Ehrenberg, 1834)	N/A	N/A	0	N/A	N/A	DQ297718
<i>Synchaeta</i> spp. (Ehrenberg, 1832)	N/A	N/A	0	N/A	N/A	N/A
Nematoda						
<i>Theristus</i> spp. (Bastian, 1865)	N/A	N/A	0	N/A	GBNM 3052-14 (g)	FJ040464 (g)
<i>Cryonema tenue</i> (Tchesunov & Riemann, 1995)	N/A	N/A	0	N/A	N/A	N/A
<i>Cryonema crassum</i> (Tchesunov & Riemann, 1995)	N/A	N/A	0	N/A	N/A	N/A
Harpacticoida						
<i>Tisbe furcata</i> (Baird, 1837)	“Raptorial” feeding [54]	Fish/nematode larvae [54], microalgae[55]	0	N/A	CAISN1 131-13	AY692343
<i>Harpacticus superflexus</i> (Willey, 1920)	N/A	N/A	0	N/A	BNSC6 23-15	EU380285 (g)
Pelagic mesozooplankton						
Calanoida						
<i>Microcalanus pusillus</i> (Sars G. O., 1903)	Cruising herbivory [35]	N/A	>200 m	N/A	9.2.1.1	AY118068 (g)

<i>Metridia longa</i> (Lubbock, 1854)	N/A	Omnivorous [56]	>200 m	N/A	9.2.1.2	AB6259 61
<i>Pseudocalanus minutus</i> (Krøyer, 1845)	Feeding current [57]	Flagellates and microalgae [58]	25-50 m	18S meta [50]	9.2.1.3	KF99120 7
<i>Pseudocalanus acuspes</i> (Giesbrecht, 1881)	Feeding current [57]	Flagellates and microalgae [58]	25-50 m	18S meta [50]	GBCRO 2522- 19	KF99120 5
<i>Pseudocalanus moultoni</i> (Frost, 1989)	Feeding current [57]	Flagellates and microalgae [58]	25-50 m	18S meta [50]	9.2.1.4	JX99532 4
Harpacticoida						
<i>Microsetella norvegica</i> (Boeck, 1865)	Particle attachmen t [59], cruising detritivory [35]	Sinking aggregates[59,6 0], Appendicularian houses [61]	<100 m	N/A	9.2.1.5	N/A
Cyclopoida						
<i>Oithona similis</i> (Claus, 1866)	Ambush predation [19,35,36]	Sinking aggregates [59], microzooplankto n [31,62,63]	<100 m	N/A	9.2.1.6	GU9691 79
<i>Triconia (Oncaea) borealis</i> (Sars G. O., 1918)	Cruising detritivory [35]	Sinking aggregates [18], Appendicularian houses [61]	>200 m	N/A	CAISN2 336-15 (g)	N/A
Benthic meiofauna						
Nematodes						
<i>Theristus</i> spp. (Bastian, 1865)	N/A	N/A	Botto m	N/A	GBNM 3052- 14 (g)	FJ04046 4 (g)
<i>Oncholaimus</i> spp. (Dujardin, 1845)	N/A	N/A	Botto m	N/A	9.2.1.7	MG6699 07.1 (g)

<i>Acantholaimus</i> spp. (Allgén, 1933)	N/A	N/A	3000-5000 m	N/A	9.2.1.8	KT7775 29.1 (g)
<i>Monhystera</i> spp. (Bastian, 1865)	N/A	N/A	3000 m	N/A	9.2.1.9	KJ63625 9.1 (g)
Harpacticoida						
<i>Tisbe furcata</i> (Baird, 1837)	"Raptorial" feeding [54]	Fish/nematode larvae [54], microalgae[55]	Bottom <300 m	N/A	CAISN1 131-13	AY6923 43

→ **Storage and shipment of samples:** Store sample-bottles at -20°C in a box labelled ("*invertebrates for diet analyses/Snorre Flo/UNIS*"). Will be unloaded at UNIS by operator after both Q1 and Q2 cruises (2020).

10.3.14 Sampling of *Pandalus borealis* for molecular analyses

Measured parameter/name: *Pandalus borealis* molecular diet analyses

Method Responsible: Kim Præbel (UiT, kim.praebel@uit.no)

Description of parameter/Aim: Sampling of *Pandalus borealis* for molecular diet analyses

Methodological description

→ **Special requirements/Gear:** Beam and Campelen Trawl

→ **Sampling depths:** Station bottom depth

→ **Chemicals used:** 95% molecular ethanol

Method:

Sample up to ca 32 individuals per station for *Pandalus*. Record the sampling station identifier, GPS coordinates, depth range of the trawl, date and time.

1. Place the EtOH at -20°C freezer near the sorting room well in advance of sampling
2. Collect 30-40 *Pandalus* per site. If possible, try to collect adults.
3. Process samples as soon as possible after the catch, in order to keep the stomachs full and to avoid post-mortem DNA degradation.
4. Wash the surface of the collected individuals by submerging them in deionized water for ~30s with gentle stirring, in order to remove macroscopic contaminating debris and eDNA contamination from fish taken in the same catch. Do not use long immersion times, to avoid osmotic shock and lysis of internal tissues.
5. If possible, when taking the specimens out of the water, use the washing flask to remove any macroscopic contamination left in the surface. Place the shrimps on a clean tissue paper to remove excess water
6. Preserve the individuals in Ice cold 96% ethanol (0 to -20 °C). Try to obtain a shrimp:EtOH ratio of 1:9, i.e. do not overfill the container/bottle with individuals, then split the sample in two containers/bottles. If low in EtOH, a little is better than no EtOH ;-).
7. If possible, add a pencil written paper note into each container with, station #, date, vessel, approximate location, your name. Store the container in the freezer at -20°C.
8. After 24-48 hours, either shake the container or, if plenty of EtOH are brought, discard the ethanol from the bottle and replace with new ice-cold ethanol.
9. Collect all the containers in a cardboard box

→ **Shipment:** Norwegian College of Fishery Science - UiT The Arctic University of Norway - Muninbakken 22 - 9037 Tromsø, Norway; ATT: Kim Præbel

Tab. 10.3-1 Overview of different types of benthos data to be generated and parameter definitions.

Quantitative community samples	Process/rate measurements	Food web	Sediment properties
Taxa lists from morphological taxonomic identifications (currently accepted name and taxonomic hierarchy for each taxon from World Register of Marine Species)	Sediment oxygen demand ($\text{mmol O}_2 \text{ m}^{-2} \text{ d}^{-1}$)	Stable isotope values, i.e. ratios of carbon and nitrogen isotopes $\delta^{15}\text{N}$ (per mil), $\delta^{13}\text{C}$ (per mil)	Chlorophyll a (mg or $\mu\text{g m}^{-2}$)
Density/Abundance: number of individuals per unit area, by species or higher taxon (unit area may be m^2 for macrofauna, km^2 for megafauna)		Diet composition (benthic meiofauna) as genetic sequence data	Phaeopigments (mg or $\mu\text{g m}^{-2}$)
Biomass: weight per unit area, by species or higher taxon (unit weight may be grams wet weight, or grams / mg / μg carbon)			Total organic carbon (mg m^{-2} and/or %)
			Sediment grain size → see geologist protocol (%fractions of silt, clay, sand; modal distribution)
			Other sediment properties → see geologist protocol

10.4 NANSEN LEGACY COLLECTION AT THE ARCTIC UNIVERSITY MUSEUM OF NORWAY

Measured parameter: Archival of faunal specimens from Nansen Legacy study area

Method responsible: Bodil Bluhm (UiT, bodil.bluhm@uit.no), Andreas Altenburger (UiT Museum, aaltenburger@snm.ku.dk – email address will be updated)

Description of parameter: The goal is to archive faunal specimens from the Nansen Legacy study area for a long-term legacy

Methodological description:

→ **Special requirements/Gear:** any gear type; preserve immediately after collection for best possible preservation Zooplankton: WP2, plankton trawl; Benthos: Campelen trawl, beam trawl, box corer

→ **Sampling depths:** Zooplankton: any; Benthos: Station bottom depth

→ **Chemicals used:** 96% ethanol, molecular grade; 4% final concentration formaldehyde seawater solution, borax or hexamethylenetetramine buffer

Method:

- Collect taxa occurring across the Nansen Legacy study area from different gear types
 - Zooplankton: WP2, plankton trawl
 - Benthos: Campelen trawl, beam trawl, box core
- First priority is to get a representation of the fauna across the study area, second priority are special concrete projects
 - Representation means: taxon collected once during a NL or other cruise from study area
- Ideally preserve 3-5 individuals per taxon each in:
 - Pre-cooled 96% ethanol and freeze (for molecular analyses)

- 4% formaldehyde seawater solution, buffered with borax or hexamethylenetetramine
- Make sure to preserve alcohol samples immediately after collection or ASAP
- Use Kautex bottle or smaller vial/jar
- Print labels, create SIOS file according to protocol

→ **Storage:**

- Formalin samples: heated space, must not freeze!
- 96% alcohol samples: ideally keep frozen at -20°C

→ **Shipping address:** UiT Museum

10.5 SEDIMENT EXTRACTION FOR TRACE ELEMENTS

Parameter measured: Trace elements from sediments

Method Responsible: Murat Ardelan (NTNU, murat.v.ardelan@ntnu.no)

Description of parameter/Aim: Quantification of the trace element distribution and speciation in the sediment, through a four steps sequential extraction.

Methodological description:

→ **Special requirements/gear:** None. Samples can be collected from Box corer or Gravity corer

→ **Sampling depths:** Station bottom depth

→ **Chemicals used:**

Material:

- Plastic spatula
- Acid washed PE sampling tubes (15ml)

Method:

- Depending on the available instrument samples might be collected for only surface sediment or different layers for a sediment depth profile.
- From each layer available, collect an amount of ~0.5 - 1 grams of sediment with the spatula
- Samples are collected in Acid washed PE tubes and stored frozen (-20 °C) until analysis.
- This is carried out in to obtain the following fractions:

Sequential Extraction:

- 1) Exchangeable, Acid Soluble
- 2) Easily Reducible
- 3) Oxidizable
- 4) Residual

10.6 DARK DIC UPTAKE IN SEDIMENTS

Parameter measured: Dark DIC uptake in sediments

Method Responsible: Tobias Vornahme (UiT, tobias.vornahme@uit.no), Rolf Gradinger (rolf.gradinger@uit.no)

Description of parameter/Aim: Estimation of dark DIC (Dissolved Inorganic Carbon) in sediments.

Methodological description:

→ **Special requirements/gear:** Isotope lab

→ **Sampling depths:** Station bottom depth

→ **Chemicals used:** 4% Formaldehyde, 1 mCi/ml ¹⁴C-bicarbonate

Method:

- From the box cores 10ml surface sediment is diluted with 10ml filtered seawater and mixed into a slurry.
- The slurry is transferred into 2ml tubes for the uptake experiments and into 3 x 1.5ml tubes for later determination of the dry weight and normalization of the uptake rates.
- 5 tubes are filled with 1ml of the slurry using a cut off 1ml pipette tip.
- 2 of the tubes are killed immediately with 1ml 4% Formaldehyde in filtered seawater. All tubes are then enriched with 4ul 1mCi/ml ¹⁴C-bicarbonate.
- A second set of 5 tubes is treated in the same way with addition of 50ul saturated nitrification inhibitor solution.
- The tubes are incubated for 24h in the dark at in situ temperatures and killed with 1ml 4% Formaldehyde in filtered seawater.
- The samples will be processed as described by Molari et al. (2013).
- Conversion factors determined from biomass experiments in the central Arctic ocean (Molar et al. in prep) will be applied to calculate bacterial and archaeal biomass production.
- Nitrification will be determined as the difference between the treatments with and without nitrification inhibitor.

Literature:

- Molari, M., Manini, E., & Dell'Anno, A. (2013). Dark inorganic carbon fixation sustains the functioning of benthic deep-sea ecosystems. *Global Biogeochemical Cycles*, 27(1), 212-221.

11. Fish

Method Responsible: Elena Eriksen (IMR, elena.eriksen@hi.no → protocol responsible)

Fish sampling will be taken on process study stations, NLEG and additional station (chapter 3, Fig 3-1). The main variables measured will be fish distribution, species, biomass, length, weight and age (Stadstad procedure); and diet. Diet will be studied by traditional way (visual analyses and records of stomach content), isotopes (special procedure), chemical analyses (samples collected during the surveys and analysed on land at lab) and genetic analyses (samples collected during the surveys and processed on board, while father analysed will be taken on land at lab).

UPDATE: IMR will not conduct sampling for fish on the Nansen LEGACY cruises in 2019. Fish sampling will be conducted at the Joint Norwegian-Russian Ecosystem survey according to standard IMR/PINRO procedure, and these data will be used in the Nansen LEGACY. Additional fish stomach sampling for the Nansen LEGACY will be conducted at some stations during the Joint Norwegian-Russian Ecosystem survey. This sampling is described below.

Tab. 11-1 Overview over lanned fish sampling activity during the Nansen Legacy cruises.

Station name	Location	Bottom depth (m)	Activity at station	Standard activity at fish lab	Additional sampling
Test station/ P1	76.00 00°N, 31.22 00°E	322	pelagic fish trawl (Harstad), demersal fish trawl (2 replicates; with and without fish lift)	Pelagisk og 1. bunnrål: Standard fish sampling, including stomach sampling of cod, polar cod and capelin.	Fish to diet genetic: 10 ind of cod, polar cod and capelin for genetic.
NLEG03	77.00 00°N,	154	pelagic fish trawl (Harstad),	Standard fish sampling, including stomach	If you didn't get samples at previous

	34.00 00°E		demersal fish trawl	sampling of cod, polar cod and capelin Fish diet: freeze 10 ind of all captured small fish species	station, so take it here!!!
P2	77.50 00°N, 34.00 00°E	190	pelagic fish trawl (Harstad), demersal fish trawl (2 replicates; with and without fish lift)	Standard fish sampling, including stomach sampling of cod, polar cod and capelin Fish diet: freeze 10 ind of all captured small fish species	Fish to diet_genetic: take one sample (10 ind) of each fish species during the survey.
M3 (mooring location)	77.87 00°N, 31.70 00°E		Acoustic surveying for mooring deployment at later survey		
NLEG07 (P3 - but will not be sampled as P- station on this survey)	78.75 00°N, 34.00 00°E	301	pelagic fish trawl (Harstad), demersal fish trawl	Standard fish sampling, including stomach sampling of cod, polar cod and capelin Fish diet: freeze 10 ind of all captured small fish species	Fish to diet_genetic: Fish to genetic: take one sample (10 ind) of each fish species during the survey
NLEG09	79.25 00°N, 34.00 00°E	215	pelagic fish trawl (Harstad), demersal fish trawl	Standard fish sampling, including stomach sampling of cod, polar cod and capelin Fish diet: freeze 10 ind of all captured small fish species	Fish to diet_genetic: take one sample (10 ind) of each fish species during the survey

Mooring location M1	79.59 30°N, 28.10 00°E		Acoustic surveying for mooring deployment at later survey		
Mooring location M2	79.67 71°N, 31.97 83°E		Acoustic surveying for mooring deployment at later survey		
P4	79.75 00°N 34.00 00°E	332	pelagic fish trawl (Harstad), demersal fish trawl (2 replicates; with and without fish lift	Standard fish sampling, including stomach sampling of cod, polar cod and capelin Fish diet: freeze 10 ind of all captured small fish species	Fish to diet_genetic: take one sample (10 ind) of each fish species during the survey
P5	80.50 00°N 34.00 00°E	167	pelagic fish trawl (Harstad), demersal fish trawl (2 replicates; with and without fish lift)	Standard fish sampling, including stomach sampling of cod, polar cod and capelin Fish diet: freeze 10 ind of all captured small fish species	Fish to diet_genetic: 10 ind of cod, polar cod and capelin for genetic.
P6	81.54 63°N 30.85 48°E	865	pelagic fish trawl (Harstad), demersal fish trawl (2 replicates; with and without fish lift)	Standard fish sampling, including stomach sampling of cod, polar cod and capelin	If you didn't get samples at previous station, so take it here!!! Fish diet: freeze 10 ind of all captured small fish species
Short-term sea ice			If possible, take a pelagic haul	If!!! So, standard fish sampling, including stomach	

stations (5 hours each)				sampling of cod, polar cod and capelin	
Sea ice stations (24 hours)/P7 if sea ice conditions are suitable for it			If possible, take a pelagic haul	If!!! So, standard fish sampling, including stomach sampling of cod, polar cod and capelin	

11.1 FISH TRAWLING/SAMPLING OF POLAR COD, ATLANTIC COD AND CAPELIN BY DEMERSAL AND PELAGIC TRAWL

Measured parameter: See protocol "[fish dissection](#)" for more information

Method Responsible: Siv Hoff (UiO, s.n.k.hoff@ibv.uio.no), Sissel Jentoft (UiO, sissel.jentoft@ibv.uio.no) and Kim Præbel (UiT, kim.praebel@uit.no)

Description of parameter/Aim: Fish trawling and sampling for polar cod, atlantic cod and capelin by demersal and pelagic trawl

Methodological description:

→ **Special requirements/gear:**

- Demersal trawl conducted with Campelen 1800# bottom trawl – provided by IMR
- Pelagic trawl conducted with Harstad type mid water trawl – provided by IMR
- Fish lift – provided by UiT
- 2x 500 L seawater tanks on deck supplied with constant running seawater –
- Provided by UiT
- Several 50 L buckets

→ **Sampling depths:**

- Demersal trawl (with the fish lift) at sea floor (approx. 200 m depth) in sound scattering layer on shelf break
- Pelagic trawl in sound scattering layer in the mesopelagic
- Demersal and pelagic trawl should be conducted on all possible stations (at least one station south of polar front, two at the central shelf and one at the northern shelf)

→ **Chemicals used:** See protocol "[11.3 Fish dissection](#)" for more information

Method:

Demersal trawl and pelagic trawl:

- Demersal trawl for 5- 15 min (trawl time depends on intensity of backscatter in sound scattering layer, checked on echosounder) at a towing speed of 2.2 – 3.4 knots
- Demersal trawl should be brought up slowly to avoid barotrauma in fish
- Pelagic trawl towed for 45 minutes at a towing speed of 2.2 – 3.4 knots (depending on intensity of backscatter in sound scattering layer, checked on echosounder)
- Empty trawl on deck in prefilled black buckets
- Quickly transfer desired fish (polar cod, Atlantic cod, capelin and other relevant species if we see that we can get nice sample size(s) of these) to seawater tanks (using small nets) for further processing and sampling
- Assess possibility of taking a second trawl to have enough fish samples for all participants
- Fish are kept in tank covered with a lid on deck and sampled successively during the next 24 hours after the trawl

→ **Sample storage/ Shipment address**

Fish will be sampled, see protocol "[11.3 Fish dissection](#)"

11.2 FISH STOMACH SAMPLING

Measured parameter: Stomach content analysis of fish

Method responsible: Institute for Marine Research (IRM, Tromsø/Bergen)

Parameter description:

Fish stomach sampling is a key element in study trophic interaction in the Barents Sea. In 2018, 203 stomachs were collected from 13 fish species sampled at the Nansen LEGACY cruise C1-2. In 2019, we plan fish stomach sampling during the Joint Norwegian-Russian Ecosystem survey with “J. Hjort” in September. Focus is on fish species with limited knowledge of feeding ecology. Diet description based on stomach analyses will be supplemented with environmental data to give better understanding to species habitat and feeding preferences.

Stomach sampling will be conducted on species according to the prioritized list given below, and on stations during the standard monitoring survey. After standard processing of fish samples (standard procedure at IMR/PINRO, https://hinnsiden.no/tema/forskning/PublishingImages/Sider/SPD-gruppen/H%C3%A5ndbok_5.0_februar%202019.pdf), fish stomach will be studied by visual analyses and records of stomach content. The processing will be conducted on board if expertise is available. If not, frozen samples will be analysed at the laboratories at IMR.

Methodological description

→ Special requirements/gear:

→ Sampling depths:

→ Chemicals used:

Sampling priority list:

Amblyraja hyperborean, Arctic skate

Bathyraja spinicauda, Spinetail ray

Rajella fyllae, Round ray

Lampanyctus macdonaldi, Rakery beaconlamp

Macrourus berglax, Rough-head grenadier
Enchelyopus cimbrius, Fourbeard rockling
Gaidropsarus argentatus, Arctic rockling
Phycis blennoides, Greater forkbeard
Gasterosteus aculeatus, Three-spined stickleback
Lophius piscatorius, Anglerfish
Sebastes norwegicus, Golden redfish
Sebastes viviparus, Norway redfish
Eutrigla gurnardus, Grey gurnard
Gymnocanthus tricuspis, Arctic staghorn sculpin
Myoxocephalus Scorpius, Shorthorn sculpin
Aspidophoroides olrikii, Northern alligatorfish
Eumicrotremus derjugini, Leatherfin lump sucker
Liparis bathyarcticus, Arctic snailfish
Lycodes eudipleurostictus, Doubleline eelpout
Lycodes polaris, Canadian eelpout
Lycodes seminudus, Longear eelpout
Anisarchus medius, Stout eelblenny
Lumpenus fabricii, Slender eelblenny
Ammodytes marinus, Lesser sandeel
Glyptocephalus cynoglossus, Witch flounder
Hippoglossus hippoglossus, Atlantic halibut
Lycodes reticulatus, Arctic eelpout
Lycodes rossi, Threespot eelpout

11.3 FISH DISSECTION/BIOLOGICAL SAMPLING FOR POLAR COD, ATLANTIC COD AND CAPELIN – GENOMIC STUDIES

Parameter measured: Biological sampling for polar cod, atlantic cod and capelin for genomic studies

Method Responsible: Siv Hoff (UiO, s.n.k.hoff@ibv.uio.no), Sissel Jentoft (UiO, sissel.jentoft@ibv.uio.no) and Kim Præbel (UiT, kim.praebel@uit.no)

Description of parameter/Aim:

- Fork length: the length of a fish measured from the most anterior part of the head to the deepest point of the notch in the tail fin.
- Total length: the length of a fish measured from the most anterior part of the head to the tip/end of the tail fin.
- Total weight: wet weight of fish in gram before dissection starts
- Presence of ectoparasites: visual check of the presence of ectoparasites on the fins or gills of the fish, record the number of ectoparasites
- Sex: is the fish male or female or immature (no gonads present in the fish)
- Gonad weight: weight of the gonad
- Liver weight: weight of the liver
- Somatic weight: weight of the fish when all inner organs are removed from the fish
- Maturation stage: On the basis of shape, size, color of the gonads and other morphological features, at least six maturity stages can be recognized
- Phenotype measurements: All parameters described above, i.e. fork length, total weight and length, presence of ectoparasites, sex, liver weight, gonad weight, maturation stage and somatic weight.

Methodological description:

→ Special requirements/gear:

- Dissection should start right after the trawl comes up to minimize stress/degradation of DNA/RNA
- We aim for dissection of 40 of each species (i.e. polar cod, capelin and Atlantic cod) in order to allow a balanced sex ratio at each station (P1, P2, P3, P4, and P5)

→ Sampling depths: see protocol "[11.1 Fish trawling](#)"

→ Chemicals used: Ethanol (96%), RNAlater

Method:

- Record fork and total length, total weight, presence of ectoparasites
- Remove otoliths, place them in envelopes (for ageing later on)
- Open the fish -> record sex, maturation stage, sample tissue samples for DNA/RNA (see details below) and at then lastly record gonad weight.
- If sampling from same individuals as the ecotox-team we will also record:

- liver weight and somatic weight in addition.

Sampling priority list (for each station):

Priority after catch	Application				N	Notes
	RNAseq full set (Sissel)	RNAseq reduced set (Sissel)	DNA Genomics (Sissel)	Phenotype (Sissel)		
1		+	+	+	40	

RNAseq reduced set

- Fish number 1 – 40: RNAseq – samples
- important to sample as soon as possible after death
- place in 5ml-15 ml cryovials with RNALater:
- Spleen*

*NB: For capelin we will instead of spleen sample liver as standard RNA sample.

DNAseq sampling set

- Fish number 1 – 40: Muscle/skin + spleen*
- place in 5ml-15 ml cryovials with 96% ethanol

*For polar cod we will sample gills instead as an additional DNAseq sample due to small size of the spleen.

→ Sample storage/ Shipment address:

- RNAseq samples RNALater (fish number 1-40)
stored at +4C during the cruise and placed at -80C for long term storage after shipment to UiO
- DNA/genomic samples 96% etanol (muscle & spleen of fish number 1-40)
stored at +4C for during the cruise and placed at -80C for long term storage after shipment to UiO
- Age determination on otoliths at room temperature
- Shipment of all samples to UiO

11.4 PRECISION-CUT LIVER SLICE (PCLS) PREPARATION AND CULTURE FOR FISH

Measured parameter: The target species are Polar cod, Atlantic cod, capelin and other fish available during trawling.

Method responsible: Fekadu Yadetie (UiB, fekadu.yadetie@uib.no)

Parameter description: This is an ex vivo tissue culture method modified from Eide et al., 2013. The method describes preparation of liver slices, culturing and exposure to chemicals onboard for later analysis in the laboratory. The target species are Polar cod, Atlantic cod, capelin and other fish available during trawling. After the trawling, fish will be kept in running seawater for few hours while processing. Depending on availability, 10-20 fish will be sampled per station.

Methodical description:

→ **Special requirements/gear:**

- Clean space for vibratome/sample handling
- Fume hood for adding chemicals
- Access to cold room
- Access to liquid nitrogen and -80 °C freezer

→ **Sampling depths:**

→ **Chemicals used:** PCLS buffer, L-15 medium (L1518 Sigma), Charcoal-stripped fetal bovine serum, Antibiotic antimycotic solution (100x), Test chemicals for exposure studies, Ethanol, DMSO, PBS buffer, Heparin, Liquid Nitrogen, RNA later

Material:

- Bucket and water tanks with flow-through seawater supply
- Vibratome
- Ice
- Culture plates (12 and 24 well)
- Pipettes and tips 0.1-1000ul
- Superglue
- Petri dishes

- Syringes and needles
- Dissection set (knives, scalpel, scissors, forceps, tweezers, blades...)
- Aluminum foil
- Microcentrifuge tubes and racks
- Cryotubes and boxes
- Falcon tubes (15ml and 50ml) and racks
- Liquid nitrogen
- Foam dewars for LN2
- Weight scale
- Incubator
- Chemical hood
- Protection equipment and consumables (gloves, lab-coats, Faceshield, face masks, Safety Glasses)
- Microcentrifuge (refrigerated)
- Refrigerator/cold room and -20 and -80 freezers
- Distilled water

NOTE: Keep sterile working conditions. Use 70% ethanol to disinfect surfaces and equipment. Change gloves as often as necessary. Work on ice. The fish tissue should not be kept at room temperature.

Method:

PREPARATIONS:

- Put PCLS buffer and on ice or in the fridge.
- Label 15 and 50 ml falcon tubes.
- Thaw FBS and anti-biotic-antimycotic solutions and prepare the **complete culture medium**: (44.5 ml L-15 medium + 5 ml FBS + 0.5 ml anti-biotic-antimycotic 100x solution). Keep on ice.
- Fill a big petri dish with the PCLS buffer.
- Label and fill small petri dishes with the **complete culture medium** for liver blocks and keep on ice.
- Prepare small petri dishes with the **complete culture medium** for collection of slices.
- Prepare labeled cryotubes, microcentrifuge tubes and aluminum foil for collecting blood and tissue (liver, bile).
- Label 15 ml tubes for histology of gonads and liver if necessary.
- Prepare dissection set (sterilized): Scissors, razor blade, knives, tweezers, etc), different size needles and syringes (5 ml, 10 ml and 50 ml), heparin, kim-wipe, tissue paper, aluminum foil, bench paper. Washing ethanol (70%), superglue.

- Spray surfaces and the vibratome with 70% ethanol.

PREPARATION AND SLICING FOR LIVER TISSUE:

1. Kill the fish by blowing in the head and measure the length and weight. After the fish is dead keep it cold (on ice).
2. Take blood samples from caudal vein, in heparinized syringe and keep it on ice in microcentruge tube. Centrifuge the blood at 2000g for 10 min and freeze plasma samples at -80°C). Take a picture of the fish.
3. Keep the fish on ice and open the peritoneal cavity taking care not to puncture the intestine. Dissect out the liver and put it in a big petri dish with ice-cold PCLS buffer. Take the bile sample using syringe and needle. Record the liver weight and keep it on ice. The liver should not come in contact with non-sterile objects. Use clean (sterile) gloves and sterilized equipment to handle the liver. Change to new ice-cold PCLS buffer (to rinse the liver), keep on ice. Take a picture of the liver.
4. Dissect the gonad and record the sex and weight. Note the developmental stage (juvenile, mature, etc). Take a picture of the gonad.
5. Carefully cut out blocks of liver tissue (approximately 3 cm long and 2 cm wide; the height may vary 1-2 cm) 2) and keep in ice-cold **complete culture medium**.
6. Using superglue to fix the blocks of liver tissue on the specimen plate of Leica vibrating blade microtome VT1200 (Leica, Wetzlar, Germany). Keep on ice until the superglue is dry and the liver tissue is stably fixed on the sample holder.
7. Assemble the specimen plate (with the tissue) into the buffer tray and the ice tray, fill the ice tray with ice and mount it on the microtome.
8. Mount and position the blade and cut 250 µm thick slices/strips at a speed of 0.9 mm/s and amplitude 3 mm. The tissue should be kept submerged in ice-cold PCLS buffer during slicing.
9. Collect the sliced 250 µm strips in a petri dish with ice-cold complete culture medium.
10. Using razor blade, cut the strips into smaller (approximately 4x4 mm) slices and pre-incubate at appropriate temperature for the species (10°C for cod) for 2 hours in the **complete culture medium** before exposure. About 4-10 slices can be cultured in 12-well plate with 2 ml **complete culture medium** per well. Divide equal number of slices into each well.
11. In the fume hood, prepare the exposure chemical in DMSO at 1000x final concentration of each dose-group (e.g. 1mM, 10mM and 100mM for final concentration of 1µM, 10µM and 100µM, respectively). Then prepare **complete culture medium** with 2x the final concentration (2µL/ml) of each dose-group.
12. After pre-incubation for 2 hours, replace half of the volume of the medium in each well (1ml) with the **complete culture medium** containing 2x the final concentration of the exposure compound and incubate at appropriate

- temperature (10°C for cod) with shaking at 50 rpm, for the required length of time (24 hours to 1 week). All wells including vehicle control should contain equal volume of DMSO (not exceeding 0.5% (v/v)).
13. At the end of the culture, carefully pick the slices with fine tweezers, rinse briefly in cold PBS or PCLS buffer and put in pre-weighed (and tared) cold cryotube and record the weight. Snap-freeze in liquid N₂ and store at -80 °C. If liquid N₂ is not available, collect the slices in a cryotube tube with RNAlater solution for RNA extraction. Incubate the samples in RNAlater solution overnight at 4°C and then transfer to -80°C for storage.
 14. Store the media (in cryotubes) at -80 °C for LDH assay and other purposes as necessary (e.g. vitellogenin assay).

11.5 SAMPLING OF BILE AND BLOOD OF ARCTIC FISH

Measured parameter: Bile and blood sampling for arctic fish: Atlantic cod, *Gadus morhua*; Polar cod, *Boreogadus saida*; Atlantic capelin, *Mallotus villosus*; and American plaice, *Hippoglossoides platessoides*.

Method responsible: Ketil Hylland (UiO, ketilhy@ibv.uio.no), Ane Harr (UiO, ane.haarr@ibv.uio.no), Torben Lode (UiO, Torben.Lode@ibv.uio.no)

Parameter description: Blood and bile will be sampled from different arctic marine fish for the analysis of DNA strand breaks and PAH metabolites, respectively. The blood samples need to be sampled fresh from live fish, and cryopreserved to avoid ice crystal formation and cell rupture. A plastic container filled with isopropanol (Mr. Frosty) allows for gradual freezing of the blood samples (around 1°C per minute) and preservation of the cells. Target species are Atlantic cod, *Gadus morhua*; Polar cod, *Boreogadus saida*; Atlantic capelin, *Mallotus villosus*; and American plaice, *Hippoglossoides platessoides*. Preferred sample size is 30 individuals per species.

Methodical description:

→ Special requirements/gear:

→ **Sampling depths:**

→ **Chemicals used:** Heparin, Dimethylsulfoxide (DMSO), Fecal calf serum (FCS), RPMI 1640 (cell medium), Ethanol, Isopropanol, RPMI 1640 (cell medium)

Material:

- Gloves
- Cryotubes (1mL)
- “Mr Frosty” box
- Isopropanol
- Ethanol for rinsing of equipment and workspace
- Scissors, scalpel and tweezers
- Syringes (0.5-1 mL) and syringe needles (23-25G)
- Heparin
- Dimethylsulfoxide (DMSO)
- Fecal calf serum (FCS)
- RPMI 1640 (cell medium)
- Pipette (1000 μ L) and pipette tips

To prepare:

- Heparinized syringes. Prepare fresh the same day and keep cool prior to sampling (4°C)
- Cryopreservation of fish blood: prepare cryosolution containing 20% FCS, 10% DMSO and 70% RPMI. Prepare fresh the same day and keep cool prior to sampling (4°C).
- Label cryotubes
- Add 300 μ L cryosolution to each tube. Keep on ice.
- Prepare Mr. Frosty by adding isopropanol to the marked line inside the box. Keep cool prior to sampling (4°C).

Method:

- The sampled fish should be alive prior to sampling. Fish that are dead from the trawling should be avoided.
- Fish are incapacitated with a blow to the head
- Take 100-200 μL blood from the caudal vein
- Transfer blood to tubes with cryosolution. Turn the tube to mix the solution. Put the tube in Mr Frosty.
- When Mr Frosty is full (can take 18 tubes), transfer the whole box to -80°C . The temperature will decrease at around 1°C per minute.
- After around 90 minutes, the tubes can be moved from Mr Frosty to boxes and kept in -80°C until shipment.
- Record metadata. If fish is shared with other groups, additional samples should be taken after blood sampling to ensure fresh blood.
- Bile is sampled from the gall bladder with a syringe. If the bile is small, the whole gall bladder can be cut out and put in a tube. Freeze at -20°C .

12. Marine mammals

Marine mammals related research, while part of the Nansen Legacy, is not a part of the RV Kronprins Håkon cruises. For further information on ongoing research contact:

Method responsible: Marin Biuw (IMR, martin.biuw@hi.no), Kit Kovacs, (NPI, kit.kovacs@npolar.no), Christian Lydersen (NPI, Christian.lydersen@npolar.no), Tore Haug (IMR, tore.haug@hi.no)

13. Ecotoxicological samples

Measured parameter: Several parameters are sampled for ecotoxicological examination

Method responsible: Katrine Borgå (UiO, katrine.borga@ibv.uio.no), Julia Giebichenstein (julia.giebichenstein@ibv.uio.no), Robynne Nowicki (robynneno@unis.no)

Parameter description: Collection of meso- and -macrozooplankton (opportunistically benthos) and fish for stable isotopes, fatty acids, protein and energy content during the Nansen Legacy biology seasonal process cruises. The taxa sampled will be the same for the aims of T2.2.1 and T2.2.5 (from Nansen Legacy project proposal) and data will be shared when overlapping parameters are analysed.

T2.2.1 Aim I: Investigate seasonal food web biomagnification of contaminants in the present climate conditions compared to 2 decades earlier. Samples will be taken of water, zooplankton, fish (and benthos) for pollutants, stable isotopes and mercury (Hg). For future cruises: birds and mammals if possible to include logistically.

T2.2.1 Aim II: Investigate seasonal and spatial patterns of energetic level and contaminants (organics and Hg) of main species at different trophic level in benthic and pelagic food chains.

T2.2.5 Aim I: Assess the seasonal variation of energetic value (caloric, protein and lipid content) of key macrozooplankton and fish Barents Sea species.

IMPORTANT:

- NOTE: **very important to avoid cross-contamination during handling.**
- Samples stored in -20C freezer.
- We will also sample opportunistically for microplastics screening, unless this is already part of the HI/NP sampling plans.

- Focus will be on the process stations which cover different areas

13.1 WATER SAMPLING

13.1.1 POPs – Persistent Organic Pollutants

Measured parameter: POPs – Persistent Organic Pollutants

Method responsible: Julia Giebichenstein (julia.giebichenstein@ibv.uio.no),
Katrine Borgå (katrine.borga@ibv.uio.no)

Parameters description: This water sampler is built at the workshop at IBV. The water sampler has a pump that actively pumps water through the system and measures the water flow with a flow meter connected inside the pump. The system is suitable for use with a glass fiber filter (293mm) and polyurethane filters (PUFs). Filter and PUFs may be extracted and analyzed for organic contaminants. It is made for use at depths down to 200 m in both fresh and saltwater. We plan to pump 3000 L, but no more than 500 L per run (approx. 3-4 hours).

The pump should be placed upstream of the ship. Attach the pump to a rope and connect it to a winch or similar to lower it either from KPH.

Methodical description:

- **Special requirements/gear:** IBVs water pump, deploy water sampler for 3-4 hours to filter water (1-4 L/min). The water sampler should be placed upstream of the ship, attached to a buoy or to the ship with wire.
- **Sampling depths:** Process stations only, via IBV water pump, we have two pumps and target Arctic and Atlantic water masses.
- **Chemicals used:** Ethanol

Material:

- Glass fiber filters, 293 µm

- Polyurethane filters (PUFs) 5.5 x 7.5 cm
- Tweezers
- Aluminum foil
- Ziploc bags (medium for PUFs and large for glass fiber filters)
- Pens
- Gloves (nitrile, powderless)
- Dell pad with software (W10)
- Extra batteries and charger
- Silicone plugs
- Ethanol for cleaning

Method:

Make sure to not wear any water repellent- or new/unwashed clothing, treated/water resistant boots, cosmetic skin products (sunscreen, moisturizer etc.). Do not handle any prepackaged food or products mentioned before when sampling. Wash hands well before handling sampling equipment.

Collect sample water from CTD mounted water collector (or similar) sampled at 50 m depth.

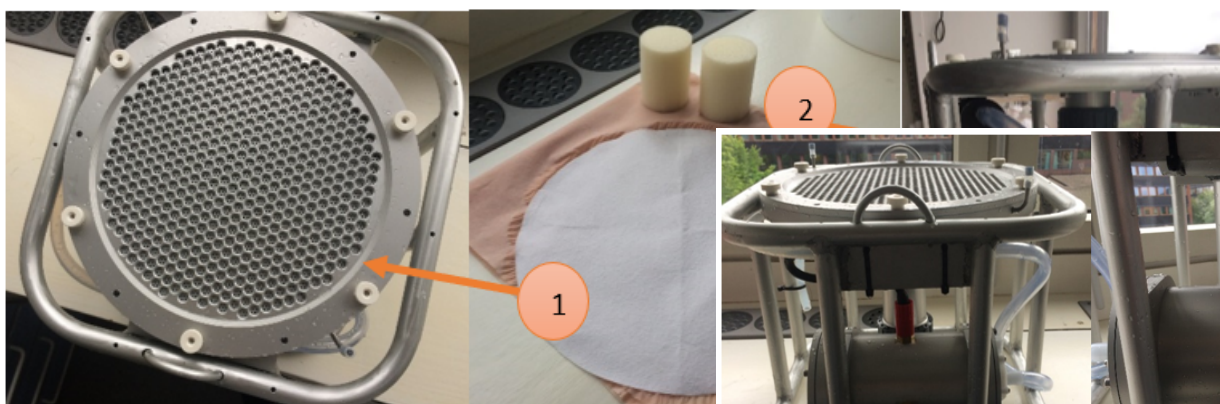

Figure 13.1.1-1 Location of glass fiber filter holder (1), and PUF holder (2)

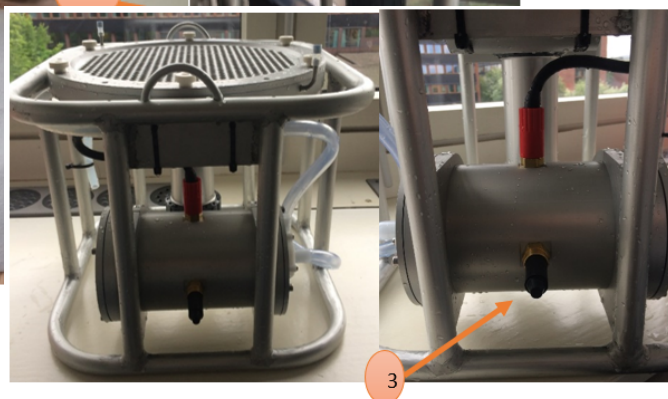

Figure 13.1.1-2 Location of connection plug to USB cable.

- i. Label two Ziploc bags per water sample with Date, Station ID, leave a blank sheet inside the bag for notes to take during the sampling (e.g. temperature, if anything didn't work out, etc.). Precut a large piece of Aluminum foil and place it in the bag (together with the second Ziploc bag).
- ii. Wearing gloves, install glass fiber filter (1) and polyurethane filters (PUFs) (2), (Figure 13.1.1-1).
- iii. *Take three field blanks per area, by lowering the pump in the water, move it a little and take it up after 2 minutes. Take out the filters, wrap them in Aluminum foil & place them in two Ziploc bags. Label the bags with station ID & Fieldblank #.*
- iv. To take the first samples, put on new gloves, install glass fiber filter and PUFs.
- v. Plug in the DELL Pad using the USB cable (3), (Figure 2). Turn on Pad (does not require any password) and check if the screen shows "BATTERY OK".
- vi. Programming the pump is done using the software named AquaFilter. Open the program and follow 3 steps:
 - a. Sett VOLUM 20-3000 liter: program amount of water to be run through the system. DO A TRIAL RUN FIRST! SET FLOW TO MINIMUM (5 minutes)
 - b. Sett FLOW 1-4 l/m: program water flow speed (1-4 L per minute). OBS! When filtering more than 1000 L water, the water flow is not optional, but needs to be set to max flow (4L per minute).
 - c. Sett START +1 - +60 min: Program time delay before the pump starts. Should be enough to soak the sampler and lower the sampler to desired depth.
- vii. The software will calculate estimated time for amount of water to be filtered at the chosen flow speed (Figure 2).
- viii. Press OK. The timer for the delay starts **as soon as you press OK**
- ix. Remove the silicone tubes and make sure the system is soaked in water before start and to avoid air disrupting the flow meter (air is drained

through two small tubes at the top of the filter). Move the pump up and down, side to side to get rid of the air inside.

- x. The USB plug may be inserted at any time if you want the process to stop.
- xi. Ensure that enough water is constantly flowing through the system: the pump will stop if the water flow is not good enough (too light flow, or particles clogging the filter).
- xii. The pump will stop after the desired volume is reached (or if something has gone wrong).
- xiii. Plug in USB and open the program on the Pad. The screen will show "MOTTAR DATA". A .txt file with information on the last run will be saved under "Aquafilter" on the C-disk.
- xiv. The file contains information on the last run (see example file, "test1208"):

Dato: date

Kl: time

VOLUM: amount of volume that has been pumped

PUMPETID: amount of time the pump has been active

STATUS: information on whether something has gone wrong (pump stopped, low flow etc.). Will display OK if everything went well.

PUMPE %: percent pump capacity

RESULTAT: volume of water that was pumped through the system

- xv. It is very important that data is downloaded and saved after every run, because the system overrides data for each run. Make your own folder and store your files after each run.
- xvi. The water sampler should be rinsed with clean, fresh water after use – especially if used in salt water or dirty water.

→ **Sample storage:** after removing the filters from the pump, wrap them in aluminum foil and place in plastic bags. Store the bag with the filters at -20°C.

13.1.2 PFAS – perfluorinated alkylated substances

Measured parameter: PFAS – perfluorinated alkylated substances

Method responsible: Julia Giebichenstein (julia.giebichenstein@ibv.uio.no),
Katrine Borgå (katrine.borga@ibv.uio.no)

Parameters measured: Water from CTD rosette, to analyze PFAS

Method responsible: Julia Giebichenstein (julia.giebichenstein@ibv.uio.no),
Katrine Borgå (katrine.borga@ibv.uio.no)

Methodical description:

- **Special requirements/gear:** CTD rosette, Niskin bottles
- **Sampling depths:** Process stations only, we target Atlantic and Arctic water masses
- **Chemicals used:** Ethanol

Method & Sample storage:

Make sure to not wear any water repellent- or new/unwashed clothing, treated/water resistant boots, cosmetic skin products (sunscreen, moisturizer etc.). Do not handle any prepackaged food, aluminum foil or products mentioned prior to sampling. Wash hands well before handling sampling equipment.

Collect sample water (1L) from CTD mounted water collector (or similar).

- I. Wearing powderless nitrile gloves, hold the 1L PP bottle underneath the water collector and fill it to the rim. There should be no air left in the bottle.
- II. Label the bottle with sample ID, station ID/position, Date using an ink pen (avoid sharpies and other black markers)
- III. Screw the lid back on and refrigerate at 4°C

13.2 ZOOPLANKTON SAMPLING

Measured parameter: Collection of meso- and macrozooplankton for persistent organic pollutants (POPs), mercury (Hg), stable isotopes, fatty acids, protein and energy content during the Nansen Legacy biology seasonal process cruises.

Method responsible: Julia Giebichenstein (julia.giebichenstein@ibv.uio.no), Robynne Nowicki (robynno@unis.no), Katrine Borgå (katrine.borga@ibv.uio.no)

Parameters description: Collection of meso- and macrozooplankton to analyse for persistent organic pollutants (POPs), mercury (Hg), stable isotopes, fatty acids, carbohydrates, protein and energy content during the Nansen Legacy biology seasonal process cruises. Additional samples are taken for Chlorinated paraffins (CPs) & perfluorinated alkylated substances (PFAS). The taxa sampled will be the same for Nansen Legacy workpackages 2.2.1 & 2.2.5, and data will be shared when overlapping parameters are analysed.

Methodological description:

→ Special requirements / Gear

- MIK net
- WP3 1000 µm (opening 1m² (NP) will be used for sample larger mesozooplankton ((only if time permits))
- Specification regarding the deployment of the different nets can be found in "Zooplankton sampling protocol AeN RF3"
- *We need information about mesozooplankton and macrozooplankton community composition, obtained in RF3.*

→ **Sampling depth:** Zooplankton samples should be sampled from the entire water column. Two samples per station, one in the Atlantic layer and one in the Arctic layer

→ **Stations:** Process stations only

→ **Chemicals used:** Ethanol (for cleaning)

Method /sample storage:

Sorting of zooplankton samples should be done as soon as possible after sampling. Samples should be diluted with *in situ* sea water and stored in 50L buckets in a cold room, to be processed as soon as possible. Keep the samples cold while sorting by use of cold packs or ice. Zooplankton should be sorted into species level if possible and larger macrozooplankton should be grouped into length groups (see table below). Samples can be stored in cryo vials, aluminum foil or zip-bags depending on the size of the sample. All samples should be stored at -20°C except for fatty acid samples that should be stored at -80°C (the other samples could also be stored at -80°C).

Organic pollutants (>5 g):

Only for RF 2.2.1

Stable isotopes (0.5 g) and Hg (0.5 g):

Mesozooplankton and small macrozooplankton samples should be stored in small cryo vials. Larger macrozooplankton, benthos and fish muscle samples should be stored in aluminum foil into plastic bags (dorsal muscle fish and larger zooplankton). Store frozen at -20°C.

Fatty acids (1 g):

We will assist others and are interested in these data, but will not have capacity for a full-scale sampling and analyses on our PM and budget. Samples should be sorted as soon as possible and cryo vials should be frozen immediately in at -80°C. Larger macrozooplankton, fish samples and benthic samples should be stored in cryo zip bags.

Energetics (1 g) & Protein:

Macrozooplankton (predominantly krill, amphipods and pteropods) length is measured and large individuals are weighed and taken as single samples, whereas smaller individuals (<20mm) are pooled to reach 0.5-1g sample weight. Samples are wrapped in foil and put into a labelled Ziploc bag. Samples will later be analysed for calorie and protein content using bomb calorimetry and the Kjeldahl method, respectively.

Table 13.3-1 Target taxa for the different sample types.

	Target taxa	Size classes /stage	Notes for length measurements	POPs	SI Hg	Energy/ protein	FA	CP/PFA S			
Sample size (g)				5	2	1	>1	5			
Number of replicates				3	3		3	3			
Priority				1	2	1	3	3			
Copepods	<i>Calanus hyperboreus</i>	CV-CVI		x	x	x		x	x		
	<i>Calanus glacialis</i>	CV-CVI		x	x	x		x	x		
	<i>Calanus finmarchicus</i>	CV-CVI		x	x	x		x	x		
	Other dominant species										
Krill	<i>Thysanoessa inermis</i>	0-10 mm	Total length- from anterior edge of the eye to the tip of the telson, excluding setae	x	x	x	x	x	x		
		10-20 mm		x	x	x	x	x	x		
		20-30 mm		x	x	x	x	x	x		
	<i>Thysanoessa longicaudata</i>	0-10 mm		x	x	x	x	x	x	x	
		10-20 mm		x	x	x	x	x	x	x	
		20-30 mm		x	x	x	x	x	x	x	
	<i>Meganyctiphanes norvegica</i>	0-10 mm		Carapace length- from the base of the eyestalk to the lateral edge of the	x	x	x	x	x	x	x
		10-20 mm			x	x	x	x	x	x	
		20-30 mm			x	x	x	x	x	x	

		> 30 mm	carapace (Silva et al., 2017)	x	x	x	x	x	x
Amphipods	<i>Themisto libellula</i>	0-10 mm	From the anterior margin of the head to the posterior margin of the third pair of uropods (Koszteyn et al., 1995)	x	x	x	x	x	x
		10-20 mm		x	x	x	x	x	x
		20-30 mm		x	x	x	x	x	x
		> 30 mm		x	x	x	x	x	x
	<i>Themisto abyssorum</i>	0-10 mm		x	x	x	x	x	x
		10-20 mm		x	x	x	x	x	x
Pteropods	<i>Clione limacina</i>			x	x	x	x	x	x
	<i>Limacina helicina</i>			x	x	x	x	x	x
Jellys	<i>Beroe cucumis</i>			x	x	x	x	x	x
	<i>Mertensia ovum</i>			x	x	x	x	x	x
Arrow worms	<i>Sagitta spp.</i>			x	x	x	x	x	x

13.3 FISH SAMPLING

Measured parameter: Collection of fishes for analyses of persistent organic pollutants (POPs), mercury (Hg), stable isotopes, fatty acids, carbohydrates, protein and energy content and chlorinated paraffins (CPs) & perfluorinated alkylated substances (PFAS).

Method responsible: Julia Giebichenstein (julia.giebichenstein@ibv.uio.no), Robynne Nowicki (robynneo@unis.no), Katrine Borgå (katrine.borga@ibv.uio.no)

Parameters description: Collection of fishes for persistent organic pollutants (POPs), mercury (Hg), stable isotopes, fatty acids and energetics during the Nansen Legacy biology seasonal process cruises. Additional samples are taken for Chlorinated paraffins (CPs) & perfluorinated alkylated substances (PFAS). The taxa sampled will be the same for 2.2.1 & 2.2.5, and data will be shared when overlapping parameters are analysed.

NB: very important to avoid cross-contamination during handling.

We will also sample opportunistically for microplastics screening, unless this is already part of the HI/NP sampling plans.

Focus will be on the process stations which cover different areas

Methodological description:

→ Special requirements / gear

Beam and Campelen trawl

Dissection should start right after the trawl comes up to minimize stress, avoid cross contamination by working as cleanly as possible

We need information about fish community composition as background information, obtained in RF3.

→ Sampling depth: See protocol "[fish trawling](#)", we are flexible on depth and not particularly bound to the stations, we are happy to trawl in the vicinity of the stations, whenever we see an acoustic signal.

→ Chemicals used: Ethanol

Method:

Fishes should be sampled with a pelagic and beam trawl. The target species are polar cod (*Boreogadus saida*), capelin (*Mallotus villosus*) and Atlantic cod (*Gadus morhua*). If other fish species (that can form seabird prey) are abundant, then these should be considered as well. Samples should be taken of muscle and liver of fishes (maximum size <25). Biometrics, such as total length, whole fish weight, liver weight, age (otoliths), sex, maturation,

reproductive stage and gross pathology (parasites, etc.) should be recorded. GIT should be sampled for diet and microplastic analyses. Carefully write location and type of tissue (M - muscle, L - liver) on the bags and vials. Fill in data at the end of each day in a excel file. Always wear gloves and clean the dissection equipment between each fish with Ethanol.

- Record total length, total weight, presence of ectoparasites
- Carefully dissect the fish and remove internal organs
- Freeze GIT
- Weigh liver, take samples for POPs
- Weigh the gonads and note the sex
- Weigh the empty fish (somatic weight)
- Take muscle (or whole fish) samples for POPs, stable isotopes, mercury
- Remove brain and otoliths

Table 13.4-1 Ecotox fish sampling overview with sampling priority

Target taxa	POPs	Stable Isotopes Total Hg	Fatty acids	PFAS /CP	Energy
Polar cod (<i>Boreogadus saida</i>)	muscle & liver / whole fish	muscle	muscle	whole fish	whole fish
Capelin (<i>Mallotus villosus</i>)	muscle & liver / whole fish	muscle	muscle	whole fish	whole fish
Atlantic cod (<i>Gadus morhua</i>)	muscle & liver / whole fish	muscle	muscle	whole fish	whole fish
Opportunistic species	muscle & liver / whole fish	muscle	muscle	whole fish	whole fish
Sample size	>5 g	2-3 g	1 g	>5 g	>5 g

<i>Number of replicates per area</i>	10	10	10
<i>Priority</i>	1	2	1

POPs:

- 10 replicates / species
- Liver tissue (>5g), muscle tissue (>5g), or whole fish
- Place in precut Aluminum sheet in Ziploc bag
- Freeze at -20°C

Mercury:

- 10 replicates / species
- Muscle tissue (1g)
- Place in Cryotube / Ziploc bag
- Freeze at -20°C

Stable isotopes:

- 10 replicates / species
- Muscle tissue (1g)
- Place in Cryotube / Ziploc bag
- Freeze at -20°C

Fatty acids:

- 10 replicates / species
- Muscle tissue
- Place in precut Aluminum sheet in Ziploc bag
- Freeze at -80°C

CPs / PFAS:

- 10 replicates / species

- Wrap the whole fish individually in Aluminum foil
- Freeze at -20°C

Energetics:

- 10 replicates / species
- Open fish and note sex
- Remove GIT, weigh and dissect to assess stomach contents. Identify contents to lowest taxonomic level when possible. Wrap GIT and contents in aluminum foil and freeze at -20°C.
- Weigh fish without GIT. Wrap whole in aluminum foil and freeze at -20°C

→ Sample storage:

- POP, stable isotope and mercury samples
- Stored at -20°C during the cruise and at -20°C after shipment to UiO
- Fatty acids
- Stored at -80°C during the cruise and at -80°C after shipment to UiO
- Energetics
- Stored at -20°C during the cruise. Stored at NPI/UiT

CPs / PFAS:

- Stored at -20°C during the cruise and at -20°C after shipment to UiO

14. Sea ice work

Method responsible: Rolf Gradinger (UiT, rolf.gradinger@uit.no), Philipp Assmy (NPI, philipp.assmy@npolar.no), Melissa Chierici (IMR, Melissa.chierici@hi.no), Agneta Fransson (NPI, agneta.fransson@npolar.no), Mats Granskog (NPI, mats.granskog@npolar.no), Anna Vader (UNIS, anna.vader@unis.no), Anette Wold (NPI, anette.wold@npolar.no), Miriam Marquardt (UiT, Miriam.marquardt@uit.no)

14.1 SAFETY BRIEF

Prior to any ice station, a safety briefing should occur. The ship leadership, chief scientist and the scientists leading the ice work should be involved. The briefing should:

- Discuss the activities at the station, time needed, distance to the ship and safety precautions.
- Include a risk evaluation (e.g. wind, temperature, ice conditions, visibility (e.g. fog), swell, polar bears and evacuation plan.
- Outline when and how many people will be on the ice, and duration of breaks with instrumentation but no people on the ice.
- Clarify communication on the ice and with the bridge (VHF channel, reporting of who is on/off the ice).
- During the polar night, take special precautions (according to weather and temperature, visibility, polar bear, etc)
- Agree upon a ship signal for immediate evacuation of the ice-floe (e.g. blowing three times the ship's horn).

14.2 SELECTION OF THE ICE FLOE

The selection of the ice station site should be done by chief scientist, leaders of the ice teams and captain. The task is to establish what kind of ice is typical for the area and which ice types exist. The team will pick a station where:

- a) the ship can safely be moored, and
- b) a typical ice type can be sampled.

While mooring the ship alongside the floe or within the floe, ice thickness can typically be evaluated. Before any person enters the ice, it should be clarified from the bridge, where sampling may occur and what is an acceptable distance from the ship.

The first people going onto the ice should wear survival suits to check ice thickness with a thickness drill at sampling sites and transect.

Some general comments regarding the ice station selection and length:

- Try to avoid ship shadow in sampling area. Choose a site at least one ship length from ship if possible.
- Relatively homogenous level ice should be preferred.
- Once the main coring site(s) for physical/biological sampling is decided upon, a clear plan should be made for where people can walk not to interfere with measurements.

- **At a short ice station (5 hours):**
 - Only one type of sea ice will be sampled.
 - No in situ BP/PP and sediment trap deployments will be conducted.
 - Additional sampling of melt ponds can be done.

- **For the long ice stations (24 hours):**
 - Ideally a second and third typical ice type (e.g. refrozen lead, thicker snow cover or other features such as ridges or multi-year ice) or regional patchiness in same ice type could be sampled by coring and covered in the snow depth and ice thickness profiles.
 - Include in situ deployment of PP/BP production measurements and sediment traps as well as extended ice thickness profiles.
 - Several types of melt ponds could be sampled.

14.3 DATA LOGGING AND PREPARATION PRIOR TO ICE STATION

14.3.1 Data logging and labelling

Decide upon a **data-responsible** who will make a common log-sheet with eventIDs for each ice-core (see [chapter 2](#)), melt pond and under-ice water sample. Each person responsible for ice samples ("responsible" in *ice sampling plan*) must log their own ice (sub)samples, using the common eventIDs as parent IDs (Tab. 14.3.1-1). That means for instance that the "responsible" *Miriam* will log all "ice meiofauna" samples. EventIDs for pooled "bio-bulk" core sections will be included in the common *ice samples overview* log-sheet.

Labelling: Each person responsible for ice samples must label according to Nansen Legacy ([chapter 2](#)) appropriate containers for cores, sections or water, and hand these over to ice team prior to the ice-station.

Tab. 14.3.1-1 Common sampling logsheet for sea ice data. The responsible needs to generate the eventIDs/parent IDs for the different ice cores that get sampled.

When pasting only use 'paste special' / 'paste only', selecting numbers and/or text

Event ID	Parent event UUID	Date	Time (UTC)	Sample Type	Description	Sample volume (mL)	Sea Ice Core Length (cm)	Sea Ice Thickness (cm)	Sea Ice Freeboard (cm)	Sampling protocol	Sample Location	Recorded By	Principal Investigator (PI)	PI initials	Event Remarks	Station Name	snow depth 1 (cm)	snow depth 2 (cm)	snow depth 3 (cm)	Fixative
6da329f2-1888-11ea-a5f2-000c29fb4a96		2019-12-06	20:30		ice station P5_ice = all samples collected from the ice at station P5_ice Anna Vader											P5_ice				
c9865bea-153c-11ea-a5f2-000c29fb4	6da329f2-1888-11ea-a5f2-000c29fb4	2019-12-06	20:30	ice co 1 - P vs l		36	31	1	AeN protoc	Anna Vader						P5_ice	13	14	14,5	
c9865bec-153c-11ea-a5f2-000c29fb4	6da329f2-1888-11ea-a5f2-000c29fb4	2019-12-06	20:30	ice co 2 - P vs l		35	32	0,5	AeN protoc	Anna Vader						P5_ice	11	11,5	12	
c9865bee-153c-11ea-a5f2-000c29fb4	6da329f2-1888-11ea-a5f2-000c29fb4	2019-12-06	20:30	ice co 3 - PP		38	33,5	0	AeN protoc	Anna Vader						P5_ice	9	9,5	11	
c9865bfb-153c-11ea-a5f2-000c29fb4	6da329f2-1888-11ea-a5f2-000c29fb4	2019-12-06	20:30	ice co 4 - PP		38,5	33,5	0	AeN protoc	Anna Vader						P5_ice	10	9	9,5	
c9865bf2-153c-11ea-a5f2-000c29fb4	6da329f2-1888-11ea-a5f2-000c29fb4	2019-12-06	20:30	ice co 5 - bio bulk 1 (incl stable isotope)		38,5	35,5	1	AeN protoc	Anna Vader						P5_ice	9	9,5	11	
c9865bf4-153c-11ea-a5f2-000c29fb4	6da329f2-1888-11ea-a5f2-000c29fb4	2019-12-06	20:30	ice co 6 - bio bulk 2 (incl stable isotope)		39	34,4	0	AeN protoc	Anna Vader						P5_ice	7,5	7	8	
c9865bfb-153c-11ea-a5f2-000c29fb4	6da329f2-1888-11ea-a5f2-000c29fb4	2019-12-06	20:30	ice co 7 - bio bulk 3 (incl stable isotope)		39	37	2	AeN protoc	Anna Vader						P5_ice	7	7	6	
c9865bfb-153c-11ea-a5f2-000c29fb4	6da329f2-1888-11ea-a5f2-000c29fb4	2019-12-06	20:30	ice co 8 - bio bulk 4 (incl stable isotope)		39	36	2	AeN protoc	Anna Vader						P5_ice	7,5	8	8	
c9865bfa-153c-11ea-a5f2-000c29fb4	6da329f2-1888-11ea-a5f2-000c29fb4	2019-12-06	20:30	ice co 9 - bio bulk 5 (incl stable isotope)		39	35	1	AeN protoc	Anna Vader						P5_ice	8	8	7	
c9865bfc-153c-11ea-a5f2-000c29fb4	6da329f2-1888-11ea-a5f2-000c29fb4	2019-12-06	20:30	ice co 10 - meiofauna/ice algae1		39	34	0,5	AeN protoc	Anna Vader						P5_ice	9	8	8	
c9865bfe-153c-11ea-a5f2-000c29fb4	6da329f2-1888-11ea-a5f2-000c29fb4	2019-12-06	20:30	ice co 11 - meiofauna/ice algae2		39	36	0	AeN protoc	Anna Vader						P5_ice	8	8	7	
c9865c00-153c-11ea-a5f2-000c29fb4	6da329f2-1888-11ea-a5f2-000c29fb4	2019-12-06	20:30	ice co 12 - meiofauna/ice algae3		39	35	0	AeN protoc	Anna Vader						P5_ice	9	10	9	
c9865beb-153c-11ea-a5f2-000c29fb4	6da329f2-1888-11ea-a5f2-000c29fb4	2019-12-06	20:30	ice co 13 - physics 2 (salinity/nutrients)		33	29	0	AeN protoc	Anna Vader						P5_ice	9	10	10	
h73f6eaa-1e78-11ea-a5f2-000c29fb4	6da329f2-1888-11ea-a5f2-000c29fb4	2019-12-06	20:30	ice co 14 - XRF1					AeN protoc	Anna Vader						taken from P5_ice				

14.3.2 Ice working teams and tentative plan

Prepare a tentative plan for ice-work (Tab. 14.3.2-1), including teams on ice and onboard (adding FSW, filtering), work load (water/ice) and polarbear guards (bridge and on sea ice). It should be announced the day before arrival.

Prior to ice station - Presentations and demos and safety brief (see [14.1](#)):

- Sea-ice security presentation by safety person in charge for all scientists working on the sea ice.
- Equipment demo (only ice teams) in "lasterom"
- Weapon demo in room next to hangars for all approved polarbear guards

On each AeN cruise, a core group should be assigned who is responsible for sampling and note keeping on the ice. In addition, a ship team should be assigned who is responsible for processing and subsampling once samples are melted (and take care that melting is done properly). If the coring for the different teams takes place at the same place, one polar bear guard is sufficient.

Two to three ice coring/sampling teams are suggested for each ice station. Each team should consist of a minimum of four ideally five people (three/four working scientists plus one polar bear guard).

NOTE: Avoid making the team too big (for safety and for logistical reasons).

A) The following teams will work on a short ice station (5 hours):

Team 1:

- ice thickness and snow depth transect (see [14.5](#), snow depth every 5 meters along a 100 m transect covering representative surface types on the floe)
- snow temperature and sampling (ideally two layers) at coring site (see [14.5.1](#))
- coring cores for Temperature/Stratigraphy, Salinity/Nutrients, Chemistry/Physics, Backup (see Tab. 14.7.1-1)

Team 2:

- coring for biological parameters (see Tab. 14.7.1-1)

Team 3 (this work can be included into Team 1 or Team 2 depending on who has completed their task first):

- under-ice water sampling (see [14.6.1](#))

- melt pond sampling (see [14.6.2](#))

B) The following teams will work on long ice stations (24 hours):

Team 1:

- ice thickness and snow depth transect (see [14.5](#), snow depth every 5 meters along a 100 m transect covering representative surface types on the floe)
- snow temperature and sampling (ideally two layers) at coring site (see [14.5.1](#))
- coring cores for Temperature/Stratigraphy, Salinity/Nutrients, Chemistry/Physics, Backup (see Tab. 14.7.1-1)

Team 2:

- coring for biological parameters (see Tab. 14.7.1-1)

Team 3:

- making hole for PP and sediment traps
- deployment of sediment traps and PP/BP as soon as ready
- melt pond sampling (see [14.6.2](#))
- under-ice water sampling (see [14.6.1](#))
- recovery of in situ deployments of sediment traps prior to any sediment/benthic sampling
- recovery of PP after ca 24 hours or end of station. BP can be recovered after 1-2 hours

Tab. 14.3.2-1 (A) Example for a tentative plan for ice work (teams, polarbear watch, sample handling onboard etc.); (B) Example for sampling grid for ice coring work to bring onto the sea ice; (C) Example sheet to bring onto the sea ice for ice core samples and under-ice water samples/meltponds.

(A)

		Early sampling (ca. 2 hours)		Later sampling (ca. 2 hours)			
		HOLE & WATER TEAM	CORING TEAM 1		CORING TEAM 2	CORING TEAM 3	POLAR BEAR GUARD
ON ICE TEAMS	Radio Marine Ch. 6	Eric (team lead, TL)	Libby (TL)		Miriam (TL)	Anette (TL)	Audun (TL)
		Robynne	Helene (5), Marti (4)		Anna	Amalia	Øystein, Snorre/Konrad
		Tore/Rochen	Ylva		Snorre	Stephen	Robynne, Tore, Eric
			Kasia		Konrad	Yasemin	Lise, Maria, (Rolf)
Co-ordination on bridge: Rolf/Janne (on bridge) & XXX (mobile on board)						Radio Channel 4	
On/ off vessel registration: Crew at gangway, report to Rolf/Janne						Radio Marine Channel 6	
ON SHIP TEAMS	Radio Channel 4	CORE HANDLING	FILTRATION TEAM	CLEAN EQUIPMENT	POLAR BEAR WATCH (BRIDGE)		
					TEAM A	TEAM B	TEAM C
		Siv/Julie	Angela, Lise, Rita	Audun	Lise	Christine	Hilde
		Rita/Angela		Anette	Angela	Arunima	Theise
(Lise/Maria)	PP deployment Marti/Audun	Julie	Rita	Silvia	Ylva		

(B)

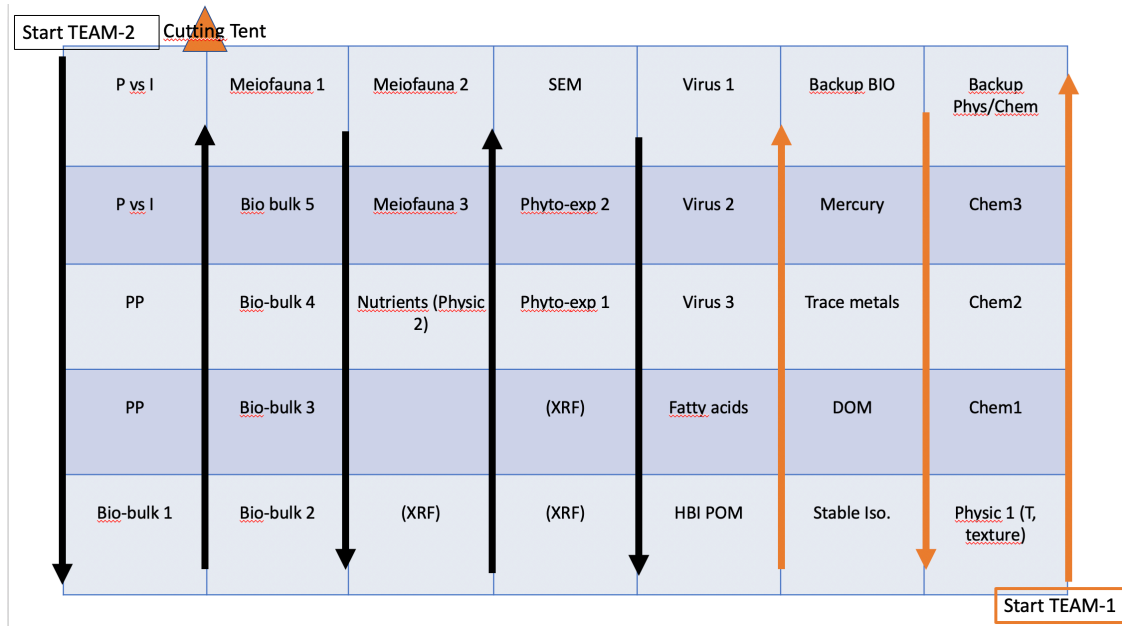

(C)

Ice cores: 9 cm Kovacs corer. Make grid (appr. 5-7m). **Nobody walks inside grid!**

- For each core, measure and note down (notebook): snow depth, core length and freeboard (device offset!)
- Core and cut. Standard sectioning BIO: 0-1, 1-3, 3-10, 10-20, 20-30, 30-50, 50-70, 70-90, 90-110, 110-130, 130-150, ++
- Add 100 ml FSW per cm core upon return to ship (in cold room, dark) according to sheet:

Core #	Parameter	Cores	Treatment	FSW?	Responsible
1-2	P vs I	2	0-1cm (remaining for Jack, bag whole), dark		Marti
3-4	PP	2	0-1cm		Marti
5	physics 1	1	measure T, make picture + notes, freeze for texture		Libby et al.
6	Physics 2	1	0-1, 1-3, 3-10, 10-20, 20-30, 30-50,.... Salinity+ nutrients		Miriam et al.
7	Chem 1	1	10 cm section, gas tight bags		Libby et al.
8	Chem 2	1	Freeze, gas tight bags		Libby et al.
9	Backup chem/phys	1	Freeze, gas tight bags		Libby et al.
10-14	bio bulk/stable isotope	5	two full cores, standard sections 0-50cm for others, dark	yes	Anna
15-17	meiofauna/algae	3	0-1, 1-3, 3-10, 10-20, 20-30cm	yes	Miriam
18	Backup Bio	1	Freeze complete, sleeve bags, mark up and bottom		Rolf et al.
19-20	phytoplank. exp	2	0-10cm, dark	yes	Marti
21-23	Virus	3	0-10cm		Hilde/Lise
24	SEM	1	0-10cm		Hilde/Lise
25	Fatty acid POM	2	0-10cm		Anette/Amal.
26	HBI POM	1	0-10cm		Anette/Amal.
27	stable isotopes	1	0-10cm		Anette/Amal.
28-29	DOM/trace metals	2	0-20cm		Stephen/Mari
30	Mercury	1	0-10cm		Maria/Steph.
31-33	XRF	(3)	0-10cm		Hilde/Lise

Under-ice water (0.5m): auger and saw to make hole for Niskin

- CTD to 90m depth
- (- LiCor light measurements)
- Collect water using Niskin, rope (marked with sampling depths) and messenger. Quadropot available. Extra weight probably needed.

	Parameter	Amount (L)	Treatment	Responsible
1	FCM/BP	0.1		Lise/Hilde
2	Chl a	1	dark	Anna, Miriam
3	POC/PON	2		Miriam
4	phytoplankton	0.2	dark	Rita
5	XRF+SEM	5.5		Lise/Hilde
6	metabarcoding	25	dark	Anna/Snorre
7	coccolithophore diversity	1		Rita
8	grazing experiments	35	only 0.5m, only P7!	Angela
9	incubations (PP)	0.5	handpump from coring hole (rig)	Marti
10	Chemistry		Handheld instrument	Libby et al

- phytoplankton net (10um), 5-0m, Rita

14.3.3 Sea ice work equipment

Prepare/pack equipment prior to ice station and charge batteries. A pallet cage can be sent onto the ice with equipment.

Tab. 14.3.3-1 Sea ice and water sampling work equipment list

Item	Amount
SEA ICE WORK	
Kovacs ice corers 9 cm	3 (ideally 4)
Cutting board (9 cm)	3
saws	4--5
Sleds for on-ice work	6
Coring drills, spare batteries, charger	3 (ideally 4)
Temperature drill Bosch	1
Thermometers (coring)	1
Salinometer	1
Thickness drilling kit (Kovacs 2" augers, thickness gauge, drill)	1
Measuring tape for sea ice thickness measurement (thickness gauge, Kovacs)	3
Measuring tape / "målestokk" for ice core length and snow depth measurement	6
shovel	2--3
Handheld GPS tracker	2
Plastic sleeves, 9 cm cores	1 roll
Thermobox to store whole ice cores	2
Melting cups, 10 cm sections without added water (Nalgene 1L)	48
Melting cups, 10 cm section with added water (White box w/red lid, small)	12
Melting cups, 20 cm section with added water (White box w/red lid, medium)	24
Melting cups, pooled samples with added water (White box w/red lid, large)	4
Pop-up tent	1
sitting mat for cutting team	1--2
riteintherain books and pencils and permanent marker for every ice coring and the water team	4 sets
Zip-lock bags (for emergency)	
stapler w/staples	
zip-ties	
head lamps for on-ice work	
headlamps for coolroom (for adding FSW)	3
1-2 L measuring beakers with handles (for adding FSW)	2
coloured rope and flags for measuring out coring grid	1

WATER/MELTPOND SAMPLING	
large ice saws (sharp!!!)	2--3
ice auger and equipment	2--3
Niskin bottle (10 L)	1--2
messenger	1--2
Hand-held water sampler (Ruttner-type from Philipp (fits through 9cm corer hole) and 5L sampler from Rolf)	1--2
Hand-held water sampler (Limnos from Agneta Fransson, NP), can be used at the ice edge/14 cm hole	1
CTD	1
pre-labelled rope (ca 100m)	1
LI-COR	1
water canisters (can be provided by people wanting the water)	
buckets for meltponds	2
throwing rope (meltpond sampling)	2
mini ctd (meltpond)	1

14.3.4 After sea ice sampling

Rinse all coring/sawing equipment (NB: cutting saw!) in fresh water and leave to dry (e.g. in the fish lab). Charge drill batteries. Take care of data logging.

14.4 SEA ICE TRANSMITTANCE AND ALBEDO DETERMINATION

Measured parameters: Hyperspectral measurements in the visible of sea ice light transmittance and albedo

Method responsible: Tristan Petit (RF1: NPI, Tristan.petit@npolar.no), Børge Hamre (RF1: UiB, borge.hamre@uib.no), Mats Granskog (RF1: NPI, mats.granskoog@npolar.no)

Description of parameter: Sea ice transmittance quantifies the ability of sea ice to let light penetrating the water. It is measured as the ratio between the downwelling irradiances taken below and above the sea ice respectively. Sea

ice albedo quantifies the ability of sea ice to reflect light back to the atmosphere. It is measured as the ratio between the upwelling and downwelling irradiances taken above the sea ice.

System description: The three quantities of interest (down/up-welling irradiances above the ice, downwelling irradiance below the ice) are measured simultaneously by 3 similar spectral scalar irradiance meters (Trios Ramses ACC-VIS). The Ramses taking under-ice measurement needs to be deployed thanks to a dedicated steal arm. The 3 radiometers are powered and connected to a unique field laptop via a Trios IPS104 communication box. On the laptop, the MSDA_XE software is used for triggering and storing the measurements into ascii files. It needs to be installed and configured (measurement triggering mode, calibration files) beforehand. Its use requires a person previously trained by one of the responsables of the method.

Preparation (on the ship before going on the ice):

- Mount the arm
- Check that battery for IPS104 is charged
- Check that laptop battery is charged
- Prepare in a box / on a pulk:
 - the 3 RAMSES radiometers
 - The IPS104 communication box + battery
 - the arm
 - the laptop (+ eventually the usb heater and extra battery if cold conditions)
 - paper and pen for metadata
 - The serial USB cable
 - The 3 RAMSES cables
 - The Tripod + plate for fixing the radiometers on it
 - Tools for fixing the radiometers on the tripod/arm

Preparation (on the ice):

- Find an area relatively homogeneous (similar colour/brightness of ice/snow) so that the measurements of albedo and transmittance can be linked together. This area should not have been previously disturbed by other activities (eg. snow removed)

- When facing sun, place the equipment behind the hole used to deploy the arm and operate only from behind the hole. This will prevent shadowing artefacts in the data.
- Mount a RAMSES (equipped with tilt and pressure sensor) at the end of the arm so that it looks upward when deployed.
- Mount the 2 other RAMSES on the tripod plate, one looking up and one looking down
- When facing sun, place the tripod with the 2 Ramses at least 5-10m on the side from the hole
- Connect the 3 RAMSES to the communication box and connect the battery to the communication box
- Connect the laptop to the communication box
- **Remove the sensor protections on each of the RAMSES**
- Check on the MSDA_XE software that all the Ramses are recognized by the software and are able to acquire proper measurements
- Check on the MSDA_XE software that air/water calibration files are correctly selected for each sensor

Deployment (requires 1 operator for the laptop and 1 operator for the arm):

The laptop operator leads the timing of the subsequent operations

1. The arm is deployed in one of the 1-5 positions (see Fig. 14.4-1) following the laptop operator instruction.
2. The laptop operator checks tilt and depth of the under-ice Ramses before measurement and asks adjustments to the arm operator if needed
3. The laptop operator runs the measurement process with MSDA_XE set to trigger simultaneously measurements on each RAMSES every 7 seconds (if doubt on the sampling frequency, check integration time of the under-ice RAMSES)
4. After 2 minutes, the laptop operator stops the measurements
5. Steps 1-4 are repeated for each of the positions of Fig. 14.4-1.
6. (*only if snow on top of the ice*) Remove the snow in an area of ~4x4m around the arm hole

7. (only if snow on top of the ice) Repeat steps 1-5

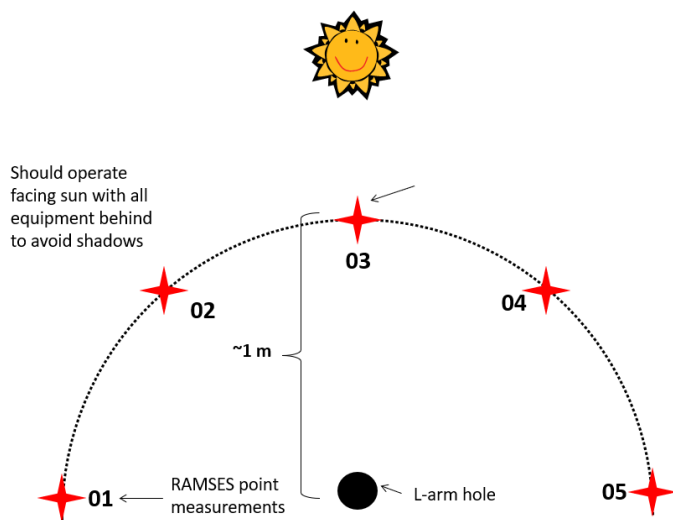

Fig. 14.4-1 Arm deployment for measurement of downwelling irradiance below the ice (adapted from a protocol shared by Benjamin Lange, NPI)

14.5 SNOW DEPTH AND ICE THICKNESS SURVEY

Requested by: Mats Granskog (NPI, mats.granskog@npolar.no), Elisabeth Jones (IMR, elizabeth.jones@hi.no), Helene Lødemel (IMR, helene.hodal.loedemel@hi.no), Melissa Chierici (IMR, melissa.chierici@hi.no), Agneta Fransson (NPI, agneta.fransson@npolar.no) , Mats Granskog (NPI, mats.granskog@npolar.no)

Parameters description: Beyond the snow depth and ice thickness at the single location of the coring, it is very useful to have some idea of the variability of snow and ice of the floe. This can also help to select additional sites for ice coring.

For either the EM observations or the manual measurements please make a sketch of the floe, sites on the floe (coring, incubations, etc.) and major

features (ridges, melt ponds, etc.), and the location of the transect in relation to these.

EM instrument operated:

In case someone operates an EM (electromagnetic) instrument that is pulled in a pulka over the floe, only a number of calibration holes for ice thickness is made (RF1). A second person then measures and records the snow depth along the EM instrument track every 5 meters (not measured exactly, but every 4-5 steps).

Manual measurement in absence of EM:

If an EM instrument is not operated, then snow depth and ice thickness need to be both recorded manually.

Optimally you select one or two transects on the floe that are long enough to capture the different surface types on the floe (i.e. level ice and possible deformed areas). But at minimum a 100 m long transect.

Along the transect measure and record snow depth every 5 meters (roughly equals 4-5 steps) using a ruler, and measure ice thickness and freeboard about every 10 m using the 2" auger and thickness gauge. Record down the measurements in a notebook (alongside a sketch).

14.5.1 Snow sampling

Requested by: Elisabeth Jones (IMR, elizabeth.jones@hi.no), Helene Lødemel (IMR, helene.hodal.loedemel@hi.no), Melissa Chierici (IMR, melissa.chierici@hi.no), Agneta Fransson (NPI, agneta.fransson@npolar.no), Mats Granskog (NPI, mats.granskog@npolar.no)

Should be done mainly for physical, chemical and nutrients properties, potentially also for biology.

BEFORE ICE CORING:

- Measure snow depth at the coring site at 10 spots in the planned coring area
- Snow samples are collected at each sea ice collection area.
- Depending on the thickness of the snow, 1-2 snow samples are collected, e.g. when snow cover is >10 cm thick, one sample 0-5 cm (ice surface to 5 cm) and one sample 5-10 cm (5 cm to snow surface) and 0-15 and 15 to 30 cm if the snow depth is 30 cm. are collected.
- Measure snow temperature of course at the two different layers (or one measurement if less snow than 15 cm).
- For DIC/AT, $\delta^{18}\text{O}$, nutrients, conductivity/salinity:
 - sample snow in plastic bags at least 3 L to get sufficient volume.
 - They are usually sampled in ziplock on the ice and then transferred to gastight bags once at the lab.
 - These are melted and then transferred to bottles for different analyses. Some will be analysed onboard.
- If there is a slushy layer, this layer is collected as well.
- Temperature is measured in each snow/slushy layer.
- The snow is collected using a plastic spoon and put into gas-tight bags, then air is removed with the air pump, then the snow sample is melted in cool and dark place.
- Same procedure is used as for the sea ice samples.
- When melted, samples for DIC/AT, $\delta^{18}\text{O}$, nutrients, conductivity/salinity are taken according to the sampling protocol (chapter [7.2](#), [7.3](#) and [7.12](#))

14.6 ICE HOLE FOR DEPLOYMENT OF IN SITU INCUBATIONS/SEDIMENT TRAPS AND UNDER-ICE WATER SAMPLING

These deployments should be done as early as possible during the long stations to allow sufficient incubation times.

Making ice hole for water sampling and deployment of PP:

- Use ice auger and ice saws to cut a hole into the sea ice (size: 75x75cm).
- If ice is thicker than 1.5m likely no hole big enough for sediment traps can be made.

- If so deploy only PP through ice hole as soon as the incubations are ready (spiked water samples from CTD and from above mentioned).
- For sediment traps an open lead close to the ship can be used (not for PP/BP) (risk: leads can close).
- Remove slush and pieces of ice from the hole using a sieve.

Sediment trap deployment:

- SQ3-August-2019: The sediment trap was deployed at the ice edge of the ice floe where ice coring was done
- SQ4-December-2019: The sediment trap was deployed at the ice edge of the ice floe where ice coring was done or through a hole in the sea ice (deployment and retrieval was however difficult)
- Sediment trap protocol [chapter 8](#)

Under-ice water/melt pond sampling:

- Select one water sampling depth (approx. 0.5 m under ice bottom) for full set of variables/parameters (similar to ice cores bio bulk sampling, see 14.7.1)
- Obtain CTD profile and light-measurements through ice hole (see below).
- If melt ponds are present, one to three melt ponds should be selected for a full set of samples similar to ice cores bio bulk (see Table 14.7.1-1)

14.6.1 Under-ice water sampling

- **CTD:** Use hand-held CTD (e.g. UiT /UNID CTD) for one deployment from the ice through auger hole down to 90m depth.
- **Water sampling:** If a small hand-held water sampler (e.g. Niskin bottle) is available, one water sampling depth should be selected (ca 0.5m under ice bottom) for full set of variables/parameters (similar to ice cores bio bulk, see Table 14.6.1-1). Some hand-held water samplers can be deployed through a 14cm ice corer hole.
 - Standard parameters to be sampled: Chl *a*, POC/PON, DNA/RNA, FCM, BP, nutrients (Requested by: Anna Vader, UNIS; Miriam Marquardt, UiT; Gunnar Bratbak, UiB; Rolf Gradinger, UiT; Philipp

Assmy, NPI), pH/DIC/TA/ dO18/nutrients (requested by Elizabeth Jones (IMR), Agneta Fransson (NPI), Melissa Chierici (IMR))

- Long ice station:
 - water for grazing experiments (Requested by: Angela Strippekugel, NTNU)
 - primary production incubations (Requested by: Marti Arumi, UiT)
 - XRF, SEM taken from Standard parameter water (Requested by: Gunnar Bratbak, UiB)

- Other parameters on request

- **Light measurements:** If available use a Li-Cor instrument to measure the PAR under the ice, through the ice auger hole or when more time:
 - Under a snow-cleared and non-cleared site
 - When in the water hole let LI-COR go down to depth where measurements negligible

- **Phytoplankton nethauls:** To be deployed through sediment trap/PP hole ideally prior to sediment trap deployment; see separate protocol on phytoplankton handnet in chapter 9.1 of the Nansen Legacy sampling protocol; (Requested by: Bente Edvardsen, UiO)

- **Fast Repetition Rate Fluorometer:** To be deployed if possible, at the same time as light measurements (or just after). → See chapter 6.4
 - An alternative for a longer ice station: time series under the ice (several hours/all day)
 - FRRf needs to be fixed from the top of the ice
 - **Long ice station:**
 - Water requested for photosynthesis analysis (Requested by Natalie Summers)

14.6.2 Melt pond sampling

If melt ponds are present, one to three melt ponds should be selected for a full set of samples similar to ice cores bio bulk (see Table 14.7.1-1)

- **CTD:** Use hand-held on-ice CTD (e.g. UiT CTD) to measure melt pond properties
- **Water sampling:** Water sampling is performed via bucket and rope technique and for chemistry parameters with a glass bottle attached to a long stick.
 - Standard parameters to be sampled: Phytoplankton taxonomy, Chl *a*, POC/PON, DNA/RNA, Nutrients (Requested by: Anna Vader, UNIS; Miriam Marquardt, UiT; Bente Edvardsen, UiO; Rolf Gradinger, UiT; Philipp Assmy, NPI - etc), pH/DIC/TA/ dO18/nutrients (requested by Elizabeth Jones (IMR), Agneta Fransson (NPI), Melissa Chierici (IMR))
 - Long ice station:
 - Trace metals/DOM (Requested by: Stephen Kohler, NTNU)
 - Primary production incubations (Requested by: Marti Arumi, UiT)
 - Ice algae taxonomy (Requested by: Bente Edvardsen, UiO)
 - XRF and SEM (Requested by: UiB Microbiology group)
 - Other parameters on request
- **Light measurements:** If available use a Li-Cor instrument to measure the PAR in the melt pond

14.7 SAMPLING OF ICE CORES

The minimum team for ice coring consists of 3 (ideally 4) people taking and processing cores and samples, one person on polar bear watch and one person taking notes.

→ Responsibilities should be clearly identified.

→ Proper labelling of all taken samples is essential (suitable containers should be labelled on ship prior to sampling).

For handling the corer:

- Use sturdy field gloves that are water proof.
- Avoid touching the cores with bare hands.
- Be careful when handling the corer to avoid cuts.
- Be very careful during the coring procedure as you are dealing with rotating gear that can break fingers...
- All cores should only be handled with lab gloves to avoid contamination. Don't touch core with bare hands and avoid using wool (thin woolen gloves can be worn below lab gloves to protect from the cold).
- Avoiding pieces of the cutting board and clothing is instrumental (thin woolen gloves can be worn below lap gloves to protect from the cold).
- **For genomic work, wear latex gloves while handling the core and be especially clean.**
- All biological process samples (PP, BP, bio bulk) should NOT be exposed to bright sunlight. Use dark foil or ice tent to protect from high light intensities.

→ Clean hand & dirty hands approach: **DIRTY HANDS** only use the corer and do not touch the core at all; **CLEAN HANDS** extract the core from the barrel and cut it.

→ **WOOL KILLS THE CARBON ANALYSIS:** people processing the cores should not wear any exposed woolen clothing that could contaminate the biological parameter cores

14.7.1 Ice core sampling, cutting scheme and ice core parameters

Ice core sampling

Ice core sampling starts with making the equipment ready, followed by snow depth measurements at the spot where the ice core will be drilled:

- Snow depth: Take 3 measurements of the snow depth with a ruler/measurement device in a 1m² triangle, note down

- After that remove snow using a shovel
- Start ice coring with Kovacs corer
- When ice core is retrieved bring it to the cutting board (into the cutting tent/outside depending on parameter)
- Use extension for coring if necessary
- The person in charge of the cutting measures and notes down the core length before cutting the core
- At the core hole take measurements of ice thickness with an ice thickness gauge and measure the ice thickness and freeboard* (with a ruler or the gauge)
- Finished? Move to next ice core sampling spot and start again!

**Freeboard: The height of the ice above water level. The freeboard can be a positive (above water level) or negative value (below water level). It gives you information about the ice floes' hydrostatic properties.*

Standard cutting scheme

Ice cores should generally be cut into 10 to 20 cm long sections starting from the top if the core is longer than one corer length (so you process the first part of the total core from the top). HOWEVER, the lowermost part of the core should be cut starting from the bottom with the following bottom segments:

Standard cutting scheme for biology (SCSB):

- 0-1 cm, 1-3 cm, 3-10 cm, 10-20 cm, 20-30 cm
→ If ice very difficult to cut 0-1cm (or no colour), then use 0-3 cm
- followed by 20 cm long sections: 30-50 cm, 50-70 cm, ...

The core sectioning for the different ice cores is included in the table below.

Ice core parameters and processing

The following table (Tab. 14.7.1-1) gives an overview about how many cores have to approx. sampled and what for and cutting schemes, followed by a more detailed description of every core parameter and its core handling procedure. Ice cores indicated for standard sampling have to be collected at

both short and long-term ice stations. The list has to be discussed onboard the ship with the scientist who plan to sample on the sea ice.

Tab. 14.7.1-1 Overview over ice cores to be sampled during ice stations. Showing the core names, number of cores that has to be sampled for a certain parameter and which parameters will be measured from it and the cutting scheme (SCSB=Standard cutting scheme for Biology). "Prio." indicates the priority of the cores to be sampled with standard cores (Std.) having highest priority at all ice stations.

Prio	Core name	Amount	Parameter measured	Measurement/Cutting scheme
Std	Temperature/Stratigraphy	1	Temperature / texture (later)	Measured (Standard), kept for Stratigraphy
Std	Salinity & Nutrients	1	Salinity & Nutrients	SCSB, melt aboard and measure salinity, sample for nutrients
Std	Chemistry/physics	1	Inorganic chemistry: Salinity/DIC/pH/Alk/dO18/nutrients	Cut in 10 cm sections, melt in gastight bags (see Fig. 14.7.1-1)
Std	Chemistry	1-2	Plastics/Backup	Full core frozen (chem backup)
Std	Chemistry/physics backup	1	As above	Full core frozen (chem backup)
Std	Backup	1	Backup	Full core frozen
Std	Bio-Bulk	5	Biology core for Chl a, POC/N, stable isotopes, DNA/RNA, Flow Cytometry (FCM) and Bacterial production (BP)	SCSB, Pool sections! Keep DARK and FSW added!
Std	Meiofauna/ice algae	3	Ice meiofauna and protist abundance	SCSB (0-30 cm) → Only the bottom 30 cm! Keep DARK and FSW added!
Std	Backup	1	Backup core	Frozen whole
2	Virus	3	Virus diversity	Bottom 0-10 cm pooled

3	XRF	3	Particulate element concentration	Bottom 0-10 cm pooled
2	PP, P vs I curve	4	Primary production and P vs I curves	cut off the bottom 1 cm - KEEP DARK!
2	Phyto-Exp	2	Phytoplankton experiments	0-10 cm (or 0-3 cm)
2	SEM	1	Scanning electron microscopy	Bottom 0-10 cm
2	Ice algae tax./cultures	1	Taxonomy, Culturing, Microscopy (SEM, TEM)	Bottom 0-10 cm
2	Fatty acid POM	1	Fatty acids of POM	Bottom 0-10 cm
2	Stable isotopes POM	1	Stable isotopes of POM	Bottom 0-10 cm
2	HBI POM	1	Highly branched isoprenoids of POM	Bottom 0-10cm
2	DOM	1	Dissolved Organic Matter	Bottom 0-10cm
2	Trace metals	1	Trace metals (see 14.6.3)	Middle 10 cm
2	Mercury	1(-3)	Mercury measurements (THg, MeHg)	Entire core into bag
2	Photosynthesis	3	Photosynthesis (Phyto-PAM), Pigments (HPLC), phytoplankton health (CytoSense)	cut off the bottom 1 cm - KEEP DARK!
2	Optics	1	Particle absorption, CDOM absorption, TSM	Full core
	TOTAL CORES:	36(38)		

The following sequence is describing more detailed core handling and responsible scientist for each core and parameter to be sampled:

Temperature/Stratigraphy cores (Std.):

Requested by:	Rolf Gradinger (UiT, rolf.gradinger@uit.no), Philipp Assmy (NPI, philipp.assmy@npolar.no), Melissa Chierici (IMR, melissa.chierici@hi.no), Agneta Fransson (NPI, agneta.fransson@npolar.no), Mats Granskog (NPI, mats.granskog@npolar.no), Miriam Marquardt (UiT, miriam.marquardt@uit.no)
Amount:	1
Parameter measured:	Measure ice in situ temperature and freeze for stratigraphy / density
Core handling:	<p>Temperature:</p> <ul style="list-style-type: none"> - Ice temperature will be measured directly on the sea ice with a T-probe as followed: - If ice thickness <1 barrel - measure (from bottom): - 2.5, 5, 10, 15, (5 cm intervals) - And at the top, also make sure there is a measurement 2.5 from surface (or closer if possible, the ice is often solid enough for that). - Record depths thoroughly. Need to note whether you used bottom or top as zero reference. - If the ice is thicker than one barrel length – you need to start measuring the first core section, from TOP – down: 2.5, 5, 10, 15.. – when you get the bottommost piece, then measure it from bottom up. NB: NOTE DOWN EVERYTHING DOWN! <p>Stratigraphy:</p> <ul style="list-style-type: none"> - core has to be frozen complete in a core bag for later analysis: - take picture of core and core sections with a ruler parallel lying to it before you put it into a sleeve bag - write shortly down what you see in the different sections (e.g. from 0 to 35 cm many air bobbles or brine channels, etc)

	<ul style="list-style-type: none"> - put into a sleeve bag and mark bottom and top on the bag and put a note written with pencil into the bag with DATE, CRUISE nID, STATION, CORE NAME (e.g. Stratigraphy), OPERATOR, TOP/BOTTOM, PART # OF # (e.g. if 3 section of one core 1, 2, 3..) - Freeze at -20 aboard the ship and take to NPI (Tromsø) for further measurements - (→ DENSITY core will be only processed when trained personnel onboard)
--	--

Salinity/Nutrient core (Std.):

Requested by:	Rolf Gradinger (UiT, rolf.gradinger@uit.no), Philipp Assmy (NPI, Philipp.Assmy@npolar.no), Melissa Chierici (IMR, melissa.chierici@hi.no), Agneta Fransson (NPI, agneta.fransson@npolar.no), Mats Granskog (NPI, mats.granskog@npolar.no), Miriam Marquardt (UiT, miriam.marquardt@uit.no)
Amount:	1
Parameter measured:	Salinity and nutrients (sections cut according to SCSB)
Core handling:	<p>Salinity/Nutrients*:</p> <ul style="list-style-type: none"> - Standard cutting scheme Biology - NO FILTERED SEAWATER (FSW) ADDED! - Ice cores are melted directly at room temperature/fish lab if constantly monitored (don't need to be dark) - When melted, mix to make sure sample is homogenous. Measure bulk salinity with a salinity meter. - Afterwards fill falcon tubes (50 ml) for nutrient analyses and freeze at -20 °C - NOTE: Nutrients do not have to be taken from this core, when Chemistry cores are taken

***NOTE:** On SQ3 cruise we only took one nutrient core, no chemistry cores, followed the standard cutting scheme and filled after melting ca. 50 ml of the ice meltwater into falcon tubes and froze at -20°C only for nutrient analysis.

Chemistry/Physics cores (Std.):

Requested by:	Elisabeth Jones (IMR, elizabeth.jones@hi.no), Helene Lødemel (IMR, helene.hodal.loedemel@hi.no), Melissa Chierici (IMR, melissa.chierici@hi.no), Agneta Fransson (NPI, agneta.fransson@npolar.no), Mats Granskog (NPI, mats.granskog@npolar.no)
Amount:	3-5
Parameter measured:	1: Inorganic chemistry: DIC/pH/Alk/dO18/nutrients 2: Inorganic chemistry: DIC/pH/Alk/dO18/nutrients 3: Backup (Stratigraphy/archive (NPI, frozen whole)) 4: Plastic 5: Backup Chemistry
Core handling:	<p>NOTE: These cores only get sampled when trained personal onboard for further processing! Otherwise they are collected into plastic tubing and processed on land.</p> <p>1: DIC/pH/Alk/dO18/nutrients:</p> <ul style="list-style-type: none"> - Cut into 0-10 cm sections (outlined in Tab. 14.7.1-1) - melt each section in special gas-tight bags (see. Fig. 14.7.1-1) - melted aboard the ship (darkness, 4°C) - When the core sections are fully melted (about 20 hrs) subsample for pH/DIC/Alk, nutrients and O18 - Samples for pH/DIC/Alk are analysed onboard and samples for nutrients and O18 are stored for analysis back on land - Further processing follow chapter 7.2, 7.3 and 7.12 <p>2: Inorganic chemistry (same as above):</p> <ul style="list-style-type: none"> - core has to be frozen completely in a special gas-tight bags for later analysis/backup

	<ul style="list-style-type: none"> - mark bottom and top on the bag - keep at -20°C freezer room <p>3: Backup (Stratigraphy/archive (NPI, frozen whole)):</p> <ul style="list-style-type: none"> - core has to be frozen completely in a special gas-tight bags/sleeve bag for later analysis/backup - follow protocol of "Stratigraphy" core - mark bottom and top on the bag - keep at -20°C freezer room
--	---

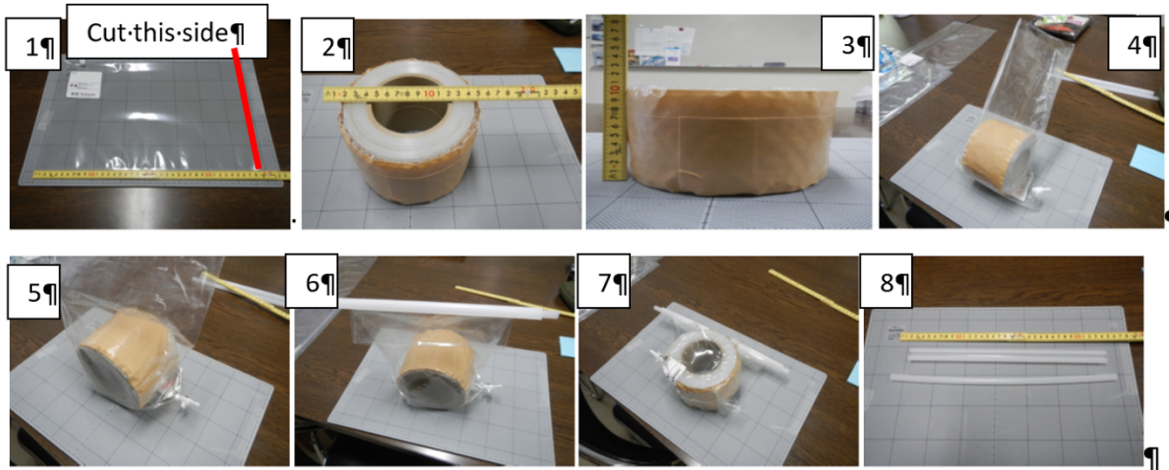

Fig. 14.7.1-1 Procedure for melting of ice cores in gas-tight bags for nutrient and chemistry cores.

Bio-bulk cores (Std.):

Requested by:	Rolf Gradinger (UiT, rolf.gradinger@uit.no), Anna Vader (UNIS, anna.vader@unis.no), Miriam Marquardt (UiT, miriam.marquardt@uit.no), Gunnar Bratbak (UiB, gunnar.bratbak@uib.no), Philipp Assmy (NPI, Philipp.Assmy@npolar.no), Bente Edvardsen (UiO, bente.edvardsen@ibv.uio.no)
Amount:	5
Parameter measured:	Chl <i>a</i> , POC/PON, DNA/RNA, stable isotope bulk, flow cytometry, bacterial production

Core handling:	<ul style="list-style-type: none"> - Keep DARK, use Latex gloves when cutting, no exposed wool clothing - standard cutting scheme transfer sections into melting buckets (1 – 6 L depending on section length), same section of the 5 cores get pooled (when container is large enough) - ADD FSW (NOTE: 0.22 µm prefiltered, 100ml per 1 cm section) - melt ice cores at room temperature if constantly monitored or in a dark and cold room (4°C) - swirl bucket contents regularly to ensure homogenous, low temperature - as soon as ice cores have melted proceed with sample processing - measure total volume of sample, and make sure sample is well mixed before subdividing into various parameters - measure and note down exact volume with measuring cylinder for each parameter - proceed as outlined in sampling protocols for each variable: <u>7.13</u>, <u>7.4</u>, <u>7.17</u>, <u>7.20</u>, <u>7.21</u>. <u>9.1</u>
-----------------------	---

Meiofauna and protist cores (Std.):

Requested by:	Rolf Gradinger (UiT, rolf.gradinger@uit.no), Miriam Marquardt (UiT, miriam.marquardt@uit.no), Bodil Bluhm (UiT, bodil.bluhm@uit.no), Philipp Assmy (philipp.assmy@npolar.no), Bente Edvardsen (UiO, bente.edvardsen@ibv.uio.no)
Amount:	3
Parameter measured:	Sympagic meiofauna and protist abundance and community composition
Core handling:	<ul style="list-style-type: none"> - keep DARK when sawing - standard cutting scheme up to 30 cm

	<ul style="list-style-type: none"> - melt buckets or zip-lock bags (double-bagged) - ADD FSW (GFF/0.22 µm; 100ml pr 1 cm section) to avoid osmotic stress <p>melt at room temperature if constantly monitored or in a dark and cold room (4°C)</p> <ul style="list-style-type: none"> - swirl bucket contents regularly to ensure homogenous, low temperature - measure total volume of sample. Make sure samples well mixed before subdividing into various parameters - After complete melt, take a 100ml subsample for protists (see. <u>7.15</u>, fix with glutaraldehyde (0.1% final concentration) and hexamine-buffered formaldehyde (1% final concentration) and concentrate the remaining volume for meiofauna (see <u>14.7.4</u>) over a 20µm sieve (2 cores: fix with buffered Formaldehyde 4% - do not freeze; 1 core: fix with Ethanol and freeze at -20°C).
--	---

Primary productivity, P vs I curve cores (prio 2):

Requested by:	Rolf Gradinger (UiT, rolf.gradinger@uit.no), Marti Amargant Arumi (UiT, marti.a.arumi@uit.no)
Amount:	4
Parameter measured:	<ul style="list-style-type: none"> - Two cores for Primary production and 15N uptake - Two cores for P vs I curves
Core handling:	<p>NOTE: These cores should be taken first, since they have to be processed immediately!</p> <p>Primary production and 15N uptake:</p> <ul style="list-style-type: none"> - keep DARK while processing - cut the lowermost 0-1 cm of two cores - place into clean zip-lock bag, add 500ml of 0.2µm filtered sea water and mix thoroughly - transfer into incubation bottles for PP - keep dark! Do all work in ice tent

	<ul style="list-style-type: none"> - immediately prepare incubations by adding tracers in isotope lab or, if possible, directly in the field - transport in DARK cooler - further processing according to <u>chapter 7.26</u> <p>P vs I curve:</p> <ul style="list-style-type: none"> - keep dark! Do all work in ice tent - cut the lowermost 0-1cm of two cores - take back to ship and add 450ml of GF/F filtered sea water in Duran bottle - use for P vs I curve - further processing according to <u>chapter 7.27</u>
--	--

Phytoplankton experiment cores (prio 2):

Requested by:	Rolf Gradinger (UiT, rolf.gradinger@uit.no), Marti Amargant Arumi (UiT, marti.a.arumi@uit.no)
Amount:	2
Parameter measured:	Phytoplankton experiments
Core handling:	<ul style="list-style-type: none"> - keep DARK while processing - cutting scheme: 0- 10cm/ (alternative: 0-3cm) - core handling will proceed onboard by trained personnel

Virus diversity cores (prio 2):

Requested by:	Gunnar Bratbak (UiB, gunnar.bratbak@uib.no)
Amount:	3

Parameter measured:	Virus diversity
Core handling:	<ul style="list-style-type: none"> - cutting scheme: 0-10cm - no FSW added - ice cores are melted directly at room temperature if constantly monitored or in a dark and cold room (4°C) - swirl bucket contents regularly to ensure homogenous, low temperature - measure total volume of sample, and make sure sample is well mixed before subdividing into various parameters - further processing follows chapter 7.22

XRF cores (prio 3):

Requested by:	Gunnar Bratbak (UiB, gunnar.bratbak@uib.no)
Amount:	3
Parameter measured:	Particulate element concentration
Core handling:	<ul style="list-style-type: none"> - cutting scheme: 0-10cm - no FSW added ilce cores are melted directly at room temperature if constantly monitored or in a dark and cold room (4°C) - swirl bucket contents regularly to ensure homogenous, low temperature - measure total volume of sample, and make sure sample is well mixed before subdividing into various parameters - further processing follows chapter 7.11

SEM core (prio 2):

Requested by:	Gunnar Bratbak (UiB, gunnar.bratbak@uib.no)
Amount:	1
Parameter measured:	Scanning electron microscopy (SEM)
Core handling:	<ul style="list-style-type: none">- cutting scheme: 0-10cm- no FSW addedice cores are melted directly at room temperature if constantly monitored or in a dark and cold room (4°C)- swirl bucket contents regularly to ensure homogenous, low temperature- measure total volume of sample, and make sure sample is well mixed before subdividing into various parameters- further processing follows chapter 7.24

Ice algae taxonomy (prio 2):

Requested by:	Bente Edvardsen (UiO, bente.edvardsen@ibv.uio.no)
Amount:	1
Parameter measured:	Ice algae taxonomy: microscopy, culturing, single cell isolation and SEM
Core handling:	<ul style="list-style-type: none">- keep DARK while processing- 0-10cm- melt buckets or zip-lock bags (double-bagged)- add FSW (1L)- ice cores are melted at room temperature if constantly monitored or in a dark and cold room (4°C)- swirl bucket contents regularly to ensure homogenous, low temperature- further processing follows chapter 7.14/9.1

Stable isotope POM (prio 2):

Requested by:	Philipp Assmy (philipp.assmy@npolar.no), Doreen Kohlbach (doreen.kohlbach@npolar.no), Anette Wold (anette.wold@npolar.no)
Amount:	1
Parameter measured:	Stable isotopes of Particulate Organic Matter (POM)
Core handling:	<ul style="list-style-type: none">- cutting scheme: 0-10cm- no FSW added- ice cores are melted at room temperature if constantly monitored or in a dark and cold room (4°C)- swirl bucket contents regularly to ensure homogenous, low temperature- measure total volume of sample, and make sure sample is well mixed before subdividing into various parameters- further processing follows chapter 9.1.5

HBI POM (prio 2):

Requested by:	Philipp Assmy (philipp.assmy@npolar.no), Doreen Kohlbach (doreen.kohlbach@npolar.no), Anette Wold (anette.wold@npolar.no)
Amount:	1
Parameter measured:	Highly branched isoprenoids (HBI) of Particulate Organic Matter (POM)
Core handling:	<ul style="list-style-type: none">- cutting scheme: 0-10cm- no FSW added- ice cores are melted directly at room temperature if constantly monitored or in a dark and cold room (4°C)- swirl bucket contents regularly to ensure homogenous, low temperature

	<ul style="list-style-type: none"> - measure total volume of sample, and make sure sample is well mixed before subdividing into various parameters - further processing follows chapter 9.1.5
--	---

Fatty acids POM (prio 2):

Requested by:	Philipp Assmy (philipp.assmy@npolar.no), Doreen Kohlbach (doreen.kohlbach@npolar.no), Anette Wold (anette.wold@npolar.no)
Amount:	1
Parameter measured:	Fatty acids of Particulate Organic Matter (POM)
Core handling:	<ul style="list-style-type: none"> - cutting scheme: 0-10cm - no FSW added - ice cores are melted directly at room temperature if constantly monitored or in a dark and cold room (4°C) - swirl bucket contents regularly to ensure homogenous, low temperature - measure total volume of sample, and make sure sample is well mixed before subdividing into various parameters - further processing follows chapter 9.1.5

DOM core (prio 2):

Requested by:	Murat Van Ardelan (NTNU, murat.v.ardelan@ntnu.no), Nicholas Sanchez (NTNU, nicholas.sanchez@ntnu.no), Stephen Kohler (NTNU, stephen.g.kohler@ntnu.no)
Amount:	1
Parameter measured:	Dissolved Organic Matter (DOM)

Core handling:	<p>NOTE: Trained personnel should perform sampling for this parameter</p> <ul style="list-style-type: none"> - KEEP DARK when sawing - Cutting scheme 0-10cm - Ice core stored in acid washed bags in dark - Ice core melting in the dark in cold room (4°C) - No FSW added - Further processing follow <u>protocol 7.6</u>
-----------------------	--

Trace metals core (prio 2):

Requested by:	Murat Van Ardelan (NTNU, murat.v.ardelan@ntnu.no), Nicholas Sanchez (NTNU, nicholas.sanchez@ntnu.no), Stephen Kohler (NTNU, stephen.g.kohler@ntnu.no)
Amount:	1
Parameter measured:	Trace metals: Iron, other trace elements and nutrients, see chapter 14.6.3
Core handling:	<p>NOTE: Trained personnel should perform sampling for this parameter</p> <ul style="list-style-type: none"> - Cut out the middle 10 cm of ice core - contamination risk for outer layer of the core is high, that is why outer layer should be removed by either ceramic (zirconium dioxide) or hard plastic knife, under dust free clean environment - after that the ice will be melted in clean PE bags and sample will transfer into acid washed Teflon or PE bottles. - No FSW added - Further processing follow <u>protocol 14.7.2</u>

Mercury core (prio 2):

Requested by:	Murat Van Ardelan (NTNU, murat.v.ardelan@ntnu.no), Nicholas Sanchez (NTNU, nicholas.sanchez@ntnu.no), Stephen Kohler (NTNU, stephen.g.kohler@ntnu.no)
Amount:	1
Parameter measured:	Mercury (THg, MeHg)
Core handling:	<p>NOTE: Trained personnel should perform sampling for this parameter</p> <ul style="list-style-type: none">- Entire core needs to be bagged, processed onboard- No FSW added- Further processing follow protocol 14.7.3

Photosynthesis core (prio 2):

Requested by:	Natalie Summers (natalie.summers@ntnu.no), Geir Johnsen (NTNU: geir.johnsen@ntnu.no)
Amount:	3
Parameter measured:	Photosynthesis (Phyto-PAM), Pigments (HPLC), phytoplankton health (CytoSense)
Core handling:	<ul style="list-style-type: none">- keep DARK and COLD while processing- 0-1 cm- melt buckets or zip-lock bags (double-bagged)- ADD filtered seawater (NOTE: 0.22 µm prefiltered, 100ml) to avoid osmotic stress- melt ice cores in a dark and cold room (4C)- swirl bucket contents regularly to ensure homogenous, low temperature- further processing protocol 7.28 - 7.30

Optics core (prio 2):

Requested by:	Tristan Petit (RF1: NPI, Tristan.petit@npolar.no)
Amount:	1
Parameter measured:	Particle absorption, CDOM absorption, TSM
Core handling:	<ul style="list-style-type: none">- full core- Sectionned, bagged, taken on board- further processing protocol 7.8 – 7.10

14.7.2 Sea ice samples for iron and other trace elements

Measured parameter: Quantification of total iron and other elements, (in nmol or $\mu\text{mol L}^{-1}$); - Core: Trace metal core (Tab. 14.6.1-1)

Method responsible: Murat Van Ardelan (NTNU, murat.v.ardelan@ntnu.no)

Parameter definition: Quantification of total iron and other elements, (in nmol or $\mu\text{mol L}^{-1}$).

Methodical description:

→ Special requirements/gear:

- Rust-free, stainless steel ice corer or equivalent
 - Rust-free, stainless steel saw or equivalent
 - Ceramic knives
 - Plastic gloves
 - Acid-washed plastic bags and containers
 - Acid-washed plastic syringes (50-60 ml)
 - Acid-washed 125 mL (Nalgene) LDPE bottles
 - 0.2+45 μm Sartobran Sartorius Filters
- Additional for the Particulate fraction**
- Polycarbonate (PC) 0.2 μm - 47mm diameter (Nucleopore)

- Acid-washed Plastic Petri dishes
- Acid-washed 500 ml PE Filtrations systems -47 mm (Nalgene)
- Vacuum pump
SPACE for Class-100 laminar flow clean-air chamber (2x2x1.5 m)

→ **Chemicals used:**

Method:

- Ice core is collected whole with stainless steel ice corer and placed in clean plastic sleeve and sealed. Plastic gloves should be worn when handling ice or collecting samples.
- ** For further processing, take the entire core into the built-in clean Lab (decrease Lab temperature to minimum during this process).
- Core is sectioned with stainless steel saw in 10cm sections
- Shave each section and place each one in clean PE bag for melting * Use the acid-washed containers to place each bag.
- Allow the entire section to melt.
- Meltwater is decanted into a 125 ml LPDE bottle for Total trace elements
- The other portion of meltwater is poured into a syringe (without plunger, 50 ml at a time) connected to a Sartorius filter. Place the syringe with the connected filter, on top of a 125 ml LDPE bottle and let it flow through gravity to obtain the Dissolved trace elements.
- Acidify samples (HNO₃) according to the water column samples.
- **Optional for Particulate trace elements**
- After obtaining the sample for Total trace element, place one acid-washed PC filter in the filter support for 500 ml acid-washed Nalgene filtration system. To avoid leakages, check for the correct fitting of the filter and tightness of the top part of the filtration system.

- Pour the remaining fraction into the filtration system. Connect the vacuum pump and turn it on at minimum pressure. The pump can be inside the built-in lab, but the escape outlet could be connected through an extended tubing, that goes outside the clean lab.
- Collect the filter in a Petri dish and freeze
- The water collected after filtration, has to be transfer to 125 ml LDPE bottle for the dissolved fraction.

14.7.3 Sea ice sampling for mercury

Measured parameter: Inorganic mercury and methylmercury - Core: Mercury core (Tab. 14.7.1-1)

Method responsible: Stephen G. Kohler (NTNU, Stephen.g.kohler@ntnu.no), Murat Van Ardelan (NTNU, murat.v.ardelan@ntnu.no)

Description of parameter: Quantification of total mercury (THg) and total methylated mercury (MeHg) in pmol L⁻¹ in sea ice cores

Methodological Description:

→ Special requirements/gear:

- Rust-free, stainless steel ice corer or equivalent
- Rust-free, stainless steel saw or equivalent
- Ceramic knives
- Hg-free gloves
- Class 100 - clean air laminar flow hood
- Clean lab space: minimum 5m² including bench and sink, covered with polyethylene plastic to form clean lab "bubble"
- Clean air filter for clean lab space

→ Chemicals used: Double-distilled hydrochloric acid (HCl)

Method:

- Ice core is collected whole with stainless steel ice corer and placed in clean plastic sleeve and sealed
- Core is sectioned onboard with stainless steel saw in 10cm sections in -20C cold lab
- Each section is shaved with acid-cleaned ceramic knife, until about 3-5mm of the outer layer is removed
- Shaved core is placed in clean PE bag for melting and brought to onboard constructed clean lab for melting
- Meltwater is decanted into pre-cleaned 40mL borosilicate amber glass bottles for rinsing for THg and 125mL brand-new PET bottles for rinsing for MeHg. Each bottle rinsed 3x with meltwater
- Sample bottle for THg filled and capped with no headspace, left unpreserved
- Sample bottle for MeHg filled and capped with no headspace, preserved with double-distilled HCl to below pH 2, approx 0.4% (v/v) HCl inside Class 100 clean air laminar flow hood
 - Note: Dimethylmercury is converted to monomethylmercury upon acidification, thus the sample represents total methylated mercury, the sum of monomethyl- and dimethylmercury
- Bottles are stored in the dark in double plastic bags at approximately 4°C before analysis

THg bottle cleaning description:

- Description roughly follows cleaning protocol recommended by "Sampling and Sample Handling for GEOTRACES Cruises, Volume 3, Chapter 8: *Protocols for Sampling and Determinations of Mercury and Its Speciation*"
- Bottles and caps are submerged in 1% (v/v) Citranox acid detergent for six (6) days
- Bottles and caps rinsed 3-5x with MilliQ water
- Bottles filled and capped with 1.2M HCl (analytical grade) for at least six (6) days
- Bottles and caps rinsed 5x with MilliQ water

- Bottles filled and capped with 0.5% (v/v) BrCl solution for 24 hours
- Bottles and caps rinsed 3x with 0.01M HCl (double distilled)
- Bottles and caps rinsed 5x with MilliQ water
- Bottles capped and stored in double-plastic bags for use

14.7.4 Sea ice meiofauna

Measured parameter: Abundance and community composition of sea ice (sympagic) meiofauna (metazoa > 20 µm)

Method responsible: Miriam Marquardt (UiT, Miriam.marquardt@uit.no), Rolf Gradinger (UiT, rolf.gradinger@uit.no), Bodil Bluhm (UiT, bodil.bluhm@uit.no)

Parameter definition: Identification (microscopy and barcoding), abundance and community composition of sea ice (sympagic) meiofauna (metazoa > 20 µm)

Methodical description:

→ **Special requirements/gear:** Kovacs (9cm) ice corer

→ **Sample depth(s):** sea ice sections: 0-1 cm, 1-3 cm, 3-10 cm, 10-20 cm, 20-30 cm

→ **Chemicals used:** Ethanol (96 %), buffered Formaldehyde (4%)

Material:

- List of sea ice equipment (Tab.14.3.3-1)
- Measuring zylinder (1000 ml, 250 ml)
- 20 µm sieve
- Squeezing bottle with FSW
- Sampling bottles (100 ml Kautex or smaller, e.g dramsglass)
- For stereo microscopy: petridish, forceps (1 soft, 1 hard), pipette (glass), picky stick to move individuals

Method:

- 3 ice cores will be sampled for assessment of sympagic meiofauna and ice protist. Sea ice sampling is described in [14.7.1](#).
- Cores getting cut according to Standard cutting scheme Biology (SCSB):
 - 0-1 cm, 1-3 cm, 3-10 cm, 10-20 cm, 20-30 cm
 - → If ice very difficult to cut 0-1cm (or no colour), then use 0-3 cm
 - followed by 20 cm long sections: 30-50 cm, 50-70 cm, ...
- But only bottom to 30 cm will be sampled and put into containers/bags. Keep cores dark and add filtered seawater (FSW: GFF/0.22 µm) aboard the ship → 100 ml per 1 cm ice section.
- melt at room temperature if constantly monitored or in a dark and cold room (4°C)
- swirl bucket contents regularly to ensure homogenous, low temperature
- measure total volume of sample. Make sure samples well mixed before subdividing into various protist and meiofauna
- After complete melt, take a 100 ml subsample for protists fix with glutaraldehyde (0.1% final concentration into brown glass bottle) and hexamine-buffered formaldehyde (1% final concentration), follow [protocol 7.15/16](#)
- Concentrate the remaining volume for meiofauna over a 20 µm sieve
- If time allows, scan or even count the sample onboard the ship with a stereomicroscope in FSW
- If no time or microscope available: fix directly 2 of the cores with buffered Formaldehyde 4% (do not freeze) and 1 core with Ethanol and freeze at -20°C. Use 100 ml Kautex sampling bottles or similar.

→ **Sample storage/transport:** Keep Ethanol samples frozen at -20°C, Formaldehyde samples at room temperature. Transport back to Miriam Marquardt - UiT/Tromsø

15. Geological sampling

Method responsible: Tine Rasmussen (UiT, tine.rasmussen@uit.no), Matthias Forwick (UiT, matthias.forwick@uit.no), Elisabeth Alve (UiO, Elisabeth.alve@geo.uio.no), Katrine Husum (NPI, katrine.husum@npolar.no), Ulysses Ninnemann (UiB, ulysses.ninnemann@uib.no)

Tab. 15-1 Overview of geological sampling effort and institutions responsible. TR: Tine Rasmussen. MF: Matthias Forwick. BF: Benthic foraminifera. PF: Planktic foraminifera. BF d18O, d13 C: stable isotope analysis ($d^{18}O$, $d^{13}C$) measured on benthic foraminifera. PF d18O, d13 C: stable isotope analysis ($d^{18}O$, $d^{13}C$) measured on planktic foraminifera.

Speciality & analysis	UiT (TR)	UiO	UiB	NPI	UiT (MF)
AMS 14C	X	X	X	X	X
210Pb	X	X	X	X	X
BF 0 - 2 ka		X			
PF 0 - 2 ka	X				
BF > 2ka	X				
PF > 2ka	X				
BF d18O, d13C 0 - 2 ka		X			
BF d18O, d13C > 2ka			X		
PF d18O, d13C 0 - 2 ka			X		
PF d18O, d13C > 2ka			X		
Water d18O, dD, d13C _{DIC}			X		
Mg/Ca			X		
Clumped isotopes			X		
HBIs (eg IP25)				X	
Diatoms				X	
Coccoliths				X	
Trace elements/Ca (ikke Mg/Ca)	X				
11B	X				
Seafloor and sub-seafloor mapping					X
Physical properties					X
X-radiographs					X
Colour imaging					X
XRF core scanning					X

Lithostratigraphy					X
Granulometry					X
IRD (flux and composition)					X

15.1 SEDIMENT SAMPLING

15.1.1 Short sediment cores (2 ka) – Multicorer

The multi corer automatically gives four multicorer tubes:

- At least two casts will be carried out with multicorer in order to obtain sediment cores for the analyses and proxies (Table 15-1).
- Three casts will be carried out at stations where it is also planned to analyze porewater and sediment geochemistry (ChAOS).
- Samples from sediment cores that are sampled onboard will be kept frozen. Other cores will be stored cold (0-5° C).
- Further processing and analysis will be carried out onshore at NPI, UiB, UiO, UiT and UniRES (see table below).

Table 15.2.1-1 Overview of multi core sampling for proxies and parameters

Proxy – parameters	Number of multicores	Partner
Paleo benthic foraminifera, planktic foraminifera	1	UiO, UiT
Living benthic foraminifera	3	
Stable isotopes	1	UiB
IP25, diatoms, aDNA, dinocysts	1	NPI, UniRES
Sedimentology	1	UiT
Reference	1	UiO/UiT/UiB/NPI
Porewater, sediment geochemistry	2	ChAOS, UiT

Multicorer - Sampling protocol:

- Remove water from multicorer tube.
- Prior to sub-sampling take a photograph of surface and one of the sediment core.
- Determine texture (clay, silt/sand/rocks) and colour using Munsell colour chart. Make notes of any disturbances, presence of benthic biota.
- Sub-sample in 0.5 cm steps down core using metal plates.
- If the sediments are very fluid spoon may also be applied.

15.1.1.1 Living (stained) and fossil benthic foraminifera

Parameter measured: Living and fossil benthic foraminifera

Method Responsible: Elisabeth Alve (UiO, Elisabeth.alve@geo.uio.no)

Description of parameter/Aim:

Methodological description:

→ **Special requirements/gear:** Multi corer (105 mm diameter)

→ **Sampling depths:** Station bottom depth

→ **Chemicals used:** Ethanol (96 %), Rose Bengal.

Material:

- Multi corer (105 mm diameter), which allows for the recovery of intact sediment-water interface.
- Stand with a piston.
- Shorter section of the core tube graduated with 1 cm mark.
- Slicing plates.
- Siphon.
- Plastic pipettes.

- 180 ml Joni plastic containers.
- Zip log bags.
- Ethanol (96 %).
- Rose Bengal.
- Notebook.
- Camera.
- Permanent marker pen.

Method:

Short multicores (~ 2 kyrs):

- Note down weather condition (if working outside) and sample process time.
- Place the core on a stand with a piston that fits the plastic core tube (Figure 15.1.1.1-1).
- Remove excess water above the sediment surface by using a siphon before pushing the core liner down on the piston in order to avoid sediment in suspension. Remove residual surface water using plastic pipettes.
- Prior to sub-sampling, take a photograph of the surface with label.
- Note down colour, texture, biota and possible disturbances, e.g. bioturbation, during slicing.
- If the sediment surface is irregular, define the sub-sample as the midpoint between the highest and the lowest point (measure the distance between these) (Schönfeld et al. 2012).
- Slice the sediment core using a slicing plate and a graduated, shorter section of the core tube (Figure 15.1.1.1-1).
- It is important to move the plate and sample horizontally when slicing to avoid dragging up sediment from the lower layer.

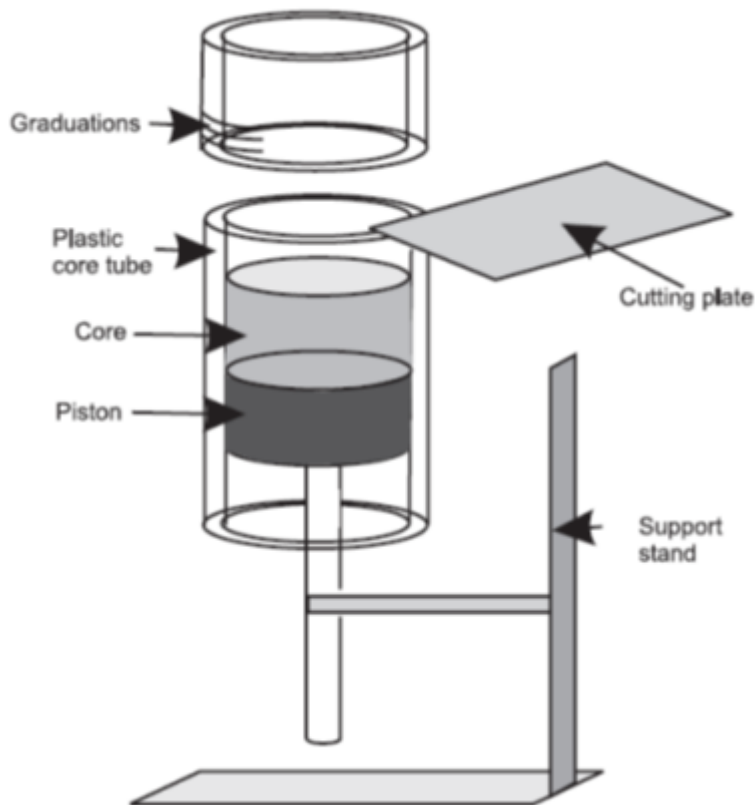

Fig. 15.1.1.1-1 Schematic representation of a stand with a piston for sediment slicing (Licensed Material: Murray 2006, Cambridge University Press)

Sampling for palaeoceanographic and fossil benthic foraminifera analyses:

- Sub-sample one sediment core in 1 cm intervals down to 40 cm.
- Due to high water content in the sediment surface, transfer samples down to 5 cm to 180 ml Joni plastic containers, and in zip log bags from 5-40 cm. Store the zip log bags in one large zip log bag to separate samples from the different stations.
- Store the sub-samples frozen (- 20 °C).
- It is important to avoid adding too much pressure on the lid when closing the plastic containers, as the containers might break. Instead, push the lid down in one place and drag your finger around until you hear a click.

Sampling for living (stained) benthic foraminifera:

- Sub-sample three sediment cores in 1 cm intervals;
- One core down to 10 cm. pH may be measured in the sub-samples.
- Two cores down to 4 cm.

- Transfer the sub-samples to 180 ml Joni plastic containers and add at least an equal volume of rose Bengal (2 g/L) stained 80 % ethanol.
- Mix the samples thoroughly (but gently) until homogenized - examine the bottom of the container to see if any sediment is still clumping together (Figure 15.1.1.1-2).
- It is important to avoid adding too much pressure on the lid when closing the plastic containers, as the containers might break. Instead, push the lid down in one place and drag your finger around until you hear a click.



Fig. 15.1.1.1-2: Well-mixed sample (left) and not sufficiently mixed sample (right).

Literature

- Murray, J.W., 2006. Ecology and Applications of Benthic Foraminifera. Cambridge University Press, Cambridge.
- Schönfeld, J., Alve, E., Geslin, E., Jorissen, F., Korsun, S., Spezzaferri, S., 2012. The FOBIMO (FOraminiferal Blo-MONitoring) initiative — Towards a standardised protocol for soft-bottom benthic foraminiferal monitoring studies. Marine Micropaleontology 94-95: 1-13.

15.1.1.2 *Stable isotopes*

- One multicorer tube will be sampled from top of the core to the bottom for every 0.5 cm.
- Samples will be kept in plastic zip log bags and frozen (< 0° C).

15.1.1.3 *Diatoms*

- One multicorer tube will be sampled from top of the core to the bottom for every 0.5 cm.
- Samples will be kept in plastic zip log bags and frozen (< 0° C).

15.1.1.4 *IP25 and Dinocyst sampling protocol*

Measured parameter: Sea ice biomarkers (IP25) and dinocysts

Method responsible: Katrine Husum (NPI, katrine.husum@npolar.no), Stijn de Schepper (UNIResearch, stde@norceresearch)

Description of parameter/Aim: Sea ice reconstruction

Methodical description:

→ Special requirements/gear:

→ Sampling depth:

→ Chemicals used:

Material:

- Spatulas
- Plastic bags
- Marker

Method:

- 1) Amount: ca. 1/3 of opened core half.
- 2) Which interval:
 - Multicore and Gravity core: 1 cm slice samples in 1 cm intervals, starting at the top.

- IP25 and Dinocyst samples were taken from multicores at stations NPAL04, NPAL05, NPAL07, NPAL08, NPAL12, NPAL14, NPAL15, NPAL17 and from gravity cores at stations NPAL04, NPAL08 and NPAL15.
- No Calypso core was sampled on the cruise.
- Diatoms were not sampled on the cruise. This is planned to be done in the same manner as IP25 and Dinocysts at a later stage (on archive half of the same cores).

3) Pre-sampling

- Cores on deck are brought to the lab.
- Cores are split. One half (work) is taken away for aDNA sampling. Another half is logged (archive). After aDNA sampling, the remaining material is sampled for IP25 and Dinocysts (multicores only).

→ Sample storage:

- Samples are stored in a cooling room at approx. 4°C.
- Transport:
 - Bergen (NORCE): Dinocyst
 - Tromsø (NPI): IP25
 Samples should be transported to Bergen/Tromsø in a cooling container.

15.1.1.5 Sedimentology

- One multicorer tube will be sampled from top of the core to the bottom for every 0.5 cm.
- Samples will be kept in plastic zip log bags.

15.1.1.6 14C-Dating sampling protocol

Parameter measured: 14C radiocarbon dating (of calcareous microfossils)

Method Responsible: Katrine Husum (NPI, katrine.husum@npolar.no), Ulysses Ninnemann (UiB, ulysses.ninnemann@uib.no), Elisabeth Alve (UiO,

Elisabeth.alve@geo.uio.no), Matthias Forwick (UiT, matthias.forwick@uit.no),
Tine Rasmussen (UiT, tine.rasmussen@uit.no)

Description of parameter/Aim: ^{14}C radiocarbon dating (of calcareous microfossils). Dating the sediment

Methodological description:

→ Special requirements/gear:

→ Sampling depths:

→ Chemicals used:

Material

- Spatulas
- Plastic bags
- Marker

Method:

- 1) Amount: ca. 1/3 of opened core half.
- 2) Which interval:
 - Multicore: 2 samples, 1 cm slices ca. 5 cm from the bottom and 5 cm from the top (or where it seems reasonable). Samples were taken from the archive half of multicores sampled for IP25 and Dinocysts.
 - Calypso/gravity core: 3 samples per section. 1 cm slices ca. 5 cm from the bottom, in the middle and 5 cm from the top (or where it seems reasonable). Samples were taken from the work half after aDNA-sampling, or pore water sampling (ChAOS)
 - Dating samples were taken from multicores at stations NPAL04, NPAL05, NPAL07, NPAL08, NPAL12, NPAL14, NPAL15, NPAL17 and from gravity cores at stations NPAL04, NPAL08, NPAL14 and NPAL15.
- 3) Pre-sampling:
 - Cores on deck are brought to the lab.

- Cores are split. One half (work) is taken away for aDNA sampling or pore water sampling. Another half is logged (archive). After, the work sections are sampled for dating (GC only). For multicores, dating samples are taken from the archive half.

→ **Sample storage/Transport:**

- Samples are stored in a freezer at approx. -20 - -30 oC.
- Transport: Samples should be transported to Tromsø on dry ice or in a freezing container to ensure that the samples.

15.1.1.7 Sediment geochemistry (ChAOS project)

- Sediment samples will be taken from one multicorer tube.
- Sediments will be sliced for every 0.5 cm resolution down to 20 cm, and in 2 cm resolution below 20 cm sediment depth.
- Samples will be kept in standard zip lock bags.
- It is critical that these samples are frozen as soon as possible after sampling (ideally at -80°C, otherwise at -20°C) and are directly transferred into a freezer back at shore.
- Data to be generated onshore at University of Leeds, UK: TOC, TN, TS, C/N ratios, Fe speciation.

15.1.1.8 Ancient DNA (aDNA) sampling protocol

Parameter measured: DNA (ancient DNA from bulk sediment samples)

Method Responsible: Stijn de Schepper (UNIResearch, stde@norceresearch),
Katrine Husum (NPI, katrine.husum@npolar.no)

Description of parameter/Aim: DNA (ancient DNA from bulk sediment samples). Purpose: Sea ice reconstruction.

Methodological description:

→ **Special requirements/gear:**

→ **Sampling depths:**

→ Chemicals used:

Material:

- single-use sterile 12ml polypropylene syringes (n= depends on sampling strategy)
- knife
- scissors
- disposable gloves (good to have both large and medium)
- single use large plastic spoons
- single use small plastic spoons
- -OR- metal spatula, wiped clean and flame-sterilised between samples
- sampling bags
- permanent marker for labelling
- sticky labels for sampling bags
- aluminum foil to work on a clean working desk and/or ethanol for cleaning workspace
- pre-cut "skumplast/oasis" (rubber foam) to fill in holes in sediment core
- Bunsen burner or lighter for flame-sterilizing knife

Method:

- Amount: At least 10cc per, more if available and if sediment is "soupy".
 - We need minimum 3 to 5-gram dry sediment for our DNA analyses.
- 1) Which interval:
- Multicore: 2 samples at 0-1.5 cm, one to be stored in the freezer (-20- -30oC) and one to be stored in the fridge (ca. 4°C).
 - All samples are taken with syringes with 1.5 cm diameter.
 - Multicores from sites where gravity cores also are taken are sampled downcore at same intervals as the gravity core to ensure overlap between the cores.
 - Calypso/gravity core: Sampled downcore at 1.5 cm slices in intervals reflecting ca. every 200-250 years.
 - Multicores were sampled at the top at every station. At station NPAL04, NPAL08, NPAL15 and NPAL17 one multicore half was sampled downcore.
 - Gravity cores from station NPAL04, NPAL08 and NPAL15 were sampled downcore.

- One piston core (KH18-10-15-PC03) was sampled. Samples were taken at the top and bottom of each section (except for section 1, where we only took bottom samples). The length of the material was measured and represents the approx. sampling interval.

2) Pre-sampling:

- Cores on deck are brought to the lab.
- Cores are split using clean tools.
- Split halves are cleaned by scraping off top sediment perpendicular to the main core axis, to avoid contamination from opening the core.
- If needed for cleaning the core/core liner: use fresh water or sterile, filtered (<0.2 µm) sea water.

3) Preparation:

On as clean workspace as possible (use aluminum foil as cover):

- Wear *clean* disposable gloves
- Label sample bags
- Label syringes with permanent marker on the tube
- Use unique labels that include cruise, station, site, core type and depth (cm):
- e.g. "SIMEP-XX-STATION-CORE-xx" or similar
- Keep a log of all sediment samples taken
- Remove top from syringe using a sterilized knife
- Pull up (not out!) inner part of syringe and put in a plastic bag.

4) Core sampling:

- Sampling control. Place an Eppendorf tube open, on the bench, close to the core and your sampling spot. Give the sampling control an ID and make sure to track which sample(s) while the tube was open.
- Press syringe into sediment. Avoid to reach the core liner – i.e. leave some sediment – to prevent contamination from the core liner
- Pull syringe out of sediment
- When syringes do not work optimally (soupy sediments) use disposable spoons or metal spatula, wiped clean and flame-sterilised between samples
- Fill hole in sediment core with "skumplast"
- Close the sampling control (i.e. keep open during process of 1-3 samples (or what seems reasonable), and freeze the sampling controls in a tube/box (the same way you treat the syringes).

→ **Sample storage/Transport:**

- Put complete syringe with sediment into labeled sampling bag. Put syringe with sample into the -20°C freezer asap
- Transport: Samples should be transported to Bergen on dry ice. At least 5-6 kg dry ice will be necessary to keep samples frozen during transport.

15.1.2 Long sediment cores (14ka) – gravity/calypso corer

The long cores are cut for every m (GC) and every 1.5 m (PC) and carefully labelled. Those sediment cores that are sampled for pore water and/or for aDNA are opened and described onboard. Further sampling onboard is problematic due to carbonate dissolution which most probably will occur when the sediments are oxygenated. All cores will be logged with regard to magnetic susceptibility, color and photographed.

Laboratory analysis (opening cores, MSCL, lithostratigraphy):

Opening cores

Cores that will be opened will be extensively sampled onboard due to the potential loss of carbonate fraction after opening. All samples will be frozen immediately. Depending upon time and capacity we will try to process all cores completely, but in the case of backlog some (e.g. longer PC) cores may be stored for post-cruise processing.

Multi Sensor Core Logger (MSCL)

The magnetic susceptibility of the sediments will be measured on the surfaces of opened cores using a point sensor attached to a GEOTEK Multi Sensor Core Logger. Simultaneously, the colour properties will be measured with a spectrophotometer. Measurements will be made for every cm onboard and with a higher resolution onshore.

Lithological description

Lithostratigraphy will be established from visual descriptions of the surfaces of opened cores. Parameters of particular interest include lithological variations, colour changes, structures, signs of biological activity (bioturbation, occurrence of whole shells and shell fragments, as well as microorganisms).

15.2 GEOLOGICAL WATER SAMPLING

15.2.1 Geology proxy development of stable isotope analysis

Parameter measured: H, O, C, $\delta^{13}\text{C}$ of DIC

Method responsible: Ulysses Ninnemann (UiB, ulysses.ninnemann@uib.no), Pål Tore Mørkved (UiB, pal.morkved@uib.no)

Description of parameter/Aim:

Methodological description:

→ **Special requirements/gear:**

→ **Sampling depths:** Upper 150m: 150, 100, 50, 25, 10, 5, 0m (adjust depending on local mixed layer and near surface stratification features).
Maximum 12 bottles

→ **Chemicals used:** Mercury(II)chloride

CTD water sampling:

- 12 x 8L Niskin bottles (bottle #1 is from the deepest depth)
- Sensors: Chl & CDOM fluorescence, O₂, transmissometer 660 nm, PAR, sPAR
- One cast whole water column for biology & chemistry

Sampling from ship CTD:

- Stable isotopes 60 ml serum vials with septa and crimp caps

Sampling depths stable isotopes (H, O, C):

- Upper 150m: 150, 100, 50, 25, 10, 5, 0m (adjust depending on local mixed layer and near surface stratification features). Maximum 12 bottles
- Lower resolution sampling to (and including as close as possible and within 10m of) seafloor to define any major water masses.
- Stable Isotopes ($\delta^{18}\text{O}$ - $\delta^2\text{D}$)

Collecting the sample:

- Sample evaporation and/or moisture condensation in the sample bottle must be avoided at all costs!
- Sampling from the Niskin bottles are done into 60 ml serum vials with butyl rubber septa and crimp caps.
 1. Rinse the vial and septum with sample three (3) times. This removes any water than may have condensed inside the bottle/cap.
 2. Fill the vial and cap with seawater from the Niskin bottle (it is practical to use a silicon tube (i.d. 7mm), similar to the DIC sampling.
 3. Apply the septum to the vial without touching the inside. Do not crimp the crimp cap. Press the septum sideways to release overpressure so the cap does not pop off.
 4. Turn the bottle upside down and check for a small air bubble. If the bubble is too small loosen the septum and tighten it again.
 5. When all the $\delta^{18}\text{O}$ samples have been collected from one CTD, dry the vials, crimp the caps (and seal with Parafilm following the instructions below / on the next page.)
 6. Store the $\delta^{18}\text{O}$ samples at room temperature or in a fridge.

Alternative for onboard measurements with a Picarro:

4b) Bring the bottles to the lab. For each sample, transfer 1.7 ml to 2 ml labelled GC vials with screwcaps and PTFE lined butyl rubber septa using a 1 ml pipette. GC vials are stored upside down in boxes with lids in the fridge.

5b) Serum vials and septa can then be emptied, washed with DI water and dried for reuse or capped and crimped for refrigerated storing of sample for backup or further onshore measurements.

Sampling for $\delta^{13}\text{C}$ of DIC in seawater:

→ **Sampling depths:** (ocean acidification studies) are as above.

→ **Chemicals used:** Mercury(II)chloride

Material:

- Glass bottles 60 ml with butyl rubber septa and crimp caps,
- silicon tube (i.d. 7mm at KH),
- Mercury(II)chloride (in saturated solution in DI water, >7.4 g/100 mL, 20 °C),
- gloves.

Method:

1. Use gloves and goggles when handling the saturated Mercury(II)chloride and the fixed samples.
2. The bottles should be numbered before sampling, please use this number as reference.
3. Rinse the vial and septum with sample three (3) times. This removes any water than may have condensed inside the bottle/cap. Use the silicone tube to transfer water from the Niskin bottles to the sampling bottles.
4. The tube should be placed in the bottom of the sampling bottle when filling. Make sure there are no bubbles inside the tube when filling. This might require reducing the flow from the Niskin bottle.
5. Overfill the sample bottle with one bottle volume. Make sure no bubbles are trapped inside the sample bottle. Put the lid on so excess water runs out (squeeze sideways and down). When you have filled all sample bottles transfer them back to the laboratory.
6. Dry all the bottles with paper towel. Paper towels go in a black or clear waste bag (normal waste).
7. Using gloves and goggles and working in the fume hood add 5 drops of saturated Mercury(II)chloride from the small drop-bottle or using syringe w/needle to each bottle. Put the septum back on and secure it with a Crimp cap. Make a permanent, separate working area for Hg work (e.g. a fume hood) to avoid spreading Hg spill to the rest of the lab. Use bench paper and change gloves often to avoid spreading the mercury.
8. Dry of the bottles with paper towel in case of spillage. This paper goes in the zip bag labelled hazardous waste.
9. Put the dry bottles in the cooling room (NO FREEZING!). In case any spill dry with paper towel and put in the yellow plastic bag. All used gloves go in the hazardous waste.

For onboard analyses on a Thermo Delta Ray instrument:

5b) One extra bottle is sampled per sample. The vial is filled as in 5).

6b) as 6).

7b) Transfer 1 ml sample, using a 1 ml syringe, to each of 3 exetainers (Labco,UK) pre-prepared with 5 drops of 99-100% phosphoric acid each. Exetainers w/acid must be flushed with synthetic air before adding the sample (usually done onshore). No Hg is needed.

8b) stir (rotate glass) gently with vial remaining near vertical to mix water and acid and measure after the water reaches constant temperature (room temperature).

16 Methods guest researchers and previous cruises

As many researchers only join 1-2 cruises and then their sampling will not be continued, we opened this chapter for protocols of guest researchers.

16.1 TOC, TN, TS, C/N RATIOS, FE SPECIATION

Measured parameters: TOC, TN, TS, C/N ratios, Fe speciation

Method responsible: Christian Maerz (University of Leeds, c.maerz@leeds.ac.uk), Matthias Forwick (UiT, matthias.forwick@uit.no), Katrine Husum (Katrine.husum@npolar.no), Ulysses Ninnemann (UiB, ulysses.ninnemann@uib.no)

Description of parameter/Aim:

Methodological description:

→ **Special requirements/gear:**

→ **Sampling depths:** Multicore (pore water) sampling: BW, 0.5, 1.5, 2.5, 4.5, 6.5, 8.5, 10.5, 12.5, 14.5, 16.5, 18.5, 20.5, 25.5, 30.5 etc.

→ **Chemicals used:** HCl

16.1.1 CTD sampling for nutrients and ICP analysis

Material:

- 12 MQW rinsed (5x) 500 mL or 1 L bottles
- 12 MQW rinsed 50 mL syringes
- 12 centrifuge tubes
- 12 60 mL Nalgene
- 12 syringe filters
- HCl (conc.)

Method:

1. Label 12 acid washed and MQW rinsed (5x) Nalgene bottles (0.5 to 1 L) for sampling from the CTD Niskin bottles.
2. When sampling from the Niskin, rinse 3 times while sampling before filling the bottle.
3. In the lab, take a dry, MQW rinsed 50 mL syringe and using the CTD water, rinse the outside of the syringe.
4. Next, take up 10 mL of CTD water in the syringe. Hold the syringe vertically and pull down on the plunger to rinse the inside of the syringe 3 times.
5. Fill the syringe with CTD water and add the syringe filter to the syringe tip. Push out 10 mL of CTD water to rinse the syringe filter.
6. Rinse the Nalgene bottle with water from syringe 3x and then fill the bottle to just below the shoulder. Close the bottle and parafilm the cap. These samples will be flash frozen at -80C for several hours and then stored in -20C for the remainder of the cruise.
7. Rinse a centrifuge tube with water from the syringe 3x and then fill the tube. Ten uL of HCl will be added to each tube and they should be stored at 4C.

16.1.2 Multicore sampling

1) Pore waters:

→ **Sample depths:** BW, 0.5, 1.5, 2.5, 4.5, 6.5, 8.5, 10.5, 12.5, 14.5, 16.5, 18.5, 20.5, 25.5, 30.5 etc.

→ **Chemicals used:** HCl

Material:

- Supplies needed
- Rhizons
- Rhizon spacers
- Syringes labelled with appropriate core depths
- Centrifuge tubes (15 mL)
- Nalgene bottles (1-60 mL and 15 mL for all sediment depths)

- Isotope vials
- HCl (conc.)

Method:

1. Core tubes should be drilled (0.4 cm) every 1 cm. The holes should be covered with clear office tape to avoid leaking.
2. Once cores are brought on deck, they should be cleaned and measured. The sediment core should then be transferred to the sink in the wet lab and secured with a bungee cord.
3. Using a pipette tip, a hole above the sediment water interface should be punctured and the rhizon inserted and attached with a syringe and a spacer. Once the syringe is filled, transfer water into the vials and tubes (and repeat) until a 60 mL Nalgene is filled for nutrients, a 15 mL centrifuge tube is filled for ICP work, a 15 mL centrifuge tube is filled for IC work, and 1 mL is transferred to the vial for isotopes. After these are full, remove the syringe and drain the remaining bottom water.
4. While bottom water is being removed, holes should be punctured and rhizons inserted starting from the bottom sample to 4.5 cm. Syringes can then be added. The 0.5 cm horizon will be set at the first sample below the sediment water interface. Once all overlying water has been removed, the holes at 2.5, 1.5 and 0.5 cm depth were opened, and rhizons were inserted very quickly to avoid the loss of pore water from the very water-rich uppermost sediment horizons. Rhizons will be left in the core tubes for up to ~2 hours, depending on the efficiency of pore water extraction (very fast in the top layers, much slower in deeper, clay-rich layers).
5. Once all rhizons have finished extracting water, the water should be divided as follows:

Sample type	Min volume	Max volume	Storage
ICP	3 mL	15 mL	10 uL HCl in centrifuge tube, stored at 4C
Nutrients	11 mL (6 for dilution)	12-13 mL	Nalgene, capped tightly and parafilmmed, flash frozen at -80C standing up before storage at -20C
Isotopes	0.5 mL	0.8-1 mL NO MORE	Transferred by syringe to vial for dry lab for analysis

IMPORTANT:

If less than 3 mL → all sample to ICP

If 3-8 mL → 1 mL to isotopes (air); remainder to ICP

If 8-15 mL → 3 mL to ICP; remainder to Nut

If 16 mL → 3 mL to ICP, 12 mL to Nut; 1 mL to isotopes (air)

If >16 mL → 12 mL to Nut; 1 mL to isotopes (air); 1 mL to isotopes (He); remainder to ICP

2) Sediments:

Material:

- Whirl pak bags
- Sampling tools (plastic plates and rings)
- pH meter (calibrated)
- pH probe
- DI bottle and Kim Wipes

Method:

1. Sediment samples for both multi- and gravity cores should be sampled and frozen soon after cores are opened to avoid oxidation of sulfides and Fe in pore waters.
2. The core should be transferred to a core extruder on deck. Remove most overlying water using a silicon tube. The pH meter should be calibrated prior to sampling. Clean pH probe with MQW water. Be sure to remove any salt from probe. Measure pH within the overlying water. The remaining water should be removed with a disposable pipette.

3. Prior to extruding core, measure pH on the surface 3 times and record by hand in notebook. Clean pH probe thoroughly with MQW water.
4. Extrude core 1 cm by turning the crank two full turns, slice and transfer to labelled bag. Sample entire core at 1 cm intervals. Samples should be stored at -20degC.

16.1.3 Gravity core sampling

1) Pore waters:

Material:

- Drill and 0.4 cm drill bits
- Rhizons
- Rhizon spacers
- Syringes labelled with appropriate core depths
- Centrifuge tubes (15 mL)
- Nalgene bottles (1-60 mL and 15 mL for all sediment depths)
- Isotope vials
- HCl (conc.)

Method:

1. Gravity core sections should be transferred to wet lab counters and secured using bungee cords.
2. Holes should be drilled every 15 to 30 cm (based on section length). A rhizon should be inserted into the hole and a syringe should be attached and a spacer added. Rhizons should be left for 2-3 hours.
3. Pore waters should be divided and treated in the same way as the multicore pore waters above.

2) Sediments:

Material:

- Sample bags
- Sampling tools (spatulas)

Method:

1. Sediment samples for both multi- and gravity cores should be sampled and frozen soon after cores are opened to avoid oxidation of sulfides and Fe in pore waters.
2. Split core should be sampled at 1 cm intervals (a third to a half of the working half).
3. Samples should be immediately frozen at -20°C.

The Nansen Legacy in numbers

6 years

The Nansen Legacy is a six-year project, running from 2018 to 2023.

1 400 000 km² of sea

The Nansen Legacy investigates the physical and biological environment of the northern Barents Sea and adjacent Arctic Ocean.



>10 fields

The Nansen Legacy includes scientists from the fields of biology, chemistry, climate research, ecosystem modelling, ecotoxicology, geology, ice physics, meteorology, observational technology, and physical oceanography.

>350 days at sea

The Nansen Legacy will conduct 15 scientific cruises and spend more than 350 days in the northern Barents Sea and adjacent Arctic Ocean between 2018 and 2022. Most of these cruises are conducted on the new Norwegian research icebreaker *RV Kronprins Haakon*.

250 people

There are about 210 researchers working with the Nansen Legacy, of which 50 are early career scientists. In addition, 40 persons are involved as technicians, project coordinators, communication advisers and board members.

10 institutions

The Nansen Legacy unites the complimentary scientific expertise of ten Norwegian institutions dedicated to Arctic research.



50/50 financing

The Nansen Legacy has a total budget of 740 million NOK. Half the budget comes from the consortiums' own funding, while the other half is provided by the Research Council of Norway and the Ministry of Education and Research.



 nansenlegacy.org

   nansenlegacy

 nansenlegacy@uit.no